

Quantum[®]

Planning Guide

Quantum Scalar i6000 Library



Scalar i6000 Planning Guide, 6-66882-12 Rev B, October 2015, Product of USA.

Quantum Corporation provides this publication “as is” without warranty of any kind, either express or implied, including but not limited to the implied warranties of merchantability or fitness for a particular purpose. Quantum Corporation may revise this publication from time to time without notice.

COPYRIGHT STATEMENT

© 2015 Quantum Corporation. All rights reserved.

Your right to copy this manual is limited by copyright law. Making copies or adaptations without prior written authorization of Quantum Corporation is prohibited by law and constitutes a punishable violation of the law.

TRADEMARK STATEMENT

Quantum, the Quantum logo, DLT, DLTape, the DLTape logo, SuperLoader, Scalar, StorNext, and DXi are registered trademarks of Quantum Corporation, registered in the U.S. and other countries.

Preserving the World's Most Important Data. Yours., Backup. Recovery. Archive. It's What We Do., the DLT logo, DLTSage, Dynamic Powerdown, FastSense, FlexLink, GoVault, MediaShield, Optyon, Pocket-sized. Well-armored, SDLT, SiteCare, SmartVerify, StorageCare, Super DLTape, and Vision are trademarks of Quantum.

LTO and Ultrium are trademarks of HP, IBM, and Quantum in the U.S. and other countries. All other trademarks are the property of their respective companies.

Specifications are subject to change without notice.



Contents

Chapter 1	About This Guide and Your Product	1
	Product Safety Statements	1
	Mercury Statement	2
	Disposal of Electrical and Electronic Equipment	2
	Product Regulatory Model Number	2
	Explanation of Symbols and Notes	3
	Other Documents You Might Need	3
	Contacts	4
	Getting More Information or Help	4
	Training	4
Chapter 2	Description	5
	Control Module	9
	Expansion Modules	18
	Dual-Robot Configurations and Parking Modules	25
	Library Management Module	29

I/O Management Unit	31
Control Management Blade	31
Fibre Channel I/O Blades	32
Ethernet Expansion Blades	32
Robot	34
Import/Export Station	34
Tape Drives and Media	35
WORM Support	36
Magazines	37
Cartridges	38
Power System	39
Host Attachment	40
Library Control Path	40
Data Path	41
Path Failover	42
Network	43
Operator Panel	43
Aisle Lights	46
Webcam	46
Tower Barcode Scanner	47
Managing Your Library Remotely	47
Slot Capacity	54
Capacity on Demand	54
Unlicensed Slots	55
Encryption and Key Management Solutions	55

Chapter 3	System Specifications	57
	Performance Specifications	58
	Environmental Specifications	59
	Electrical Specifications	60
	Module Electrical Specifications	60
	Supported Power Connectors	62
	Module Power Consumption	63

Library Connection Types and Speeds 65

Physical Specifications – Pallet 66
 Pallet Specifications 66

Physical Specifications – Library 66
 Configuration Rules 67
 Basic Building Blocks 69
 Examples of Common Configurations 72

Module Foot Pad Positions 77

Module Floor Cutout 78

LTO Drive Requirements and Compatibility 80

Barcode Requirements 82

Chapter 4

Site Preparations 85

 General Information 86

 Physical Environment 88

 Access Conditions 90

 Required Configuration Information 94

 SAN Readiness 96
 NPIV Requirements 97

 Dual Robotics Upgrade Requirements 97

 Gen 2 Single Robotics Upgrade Requirements 98

 High-density Expansion Module Requirements 99

 Additional Comments 99

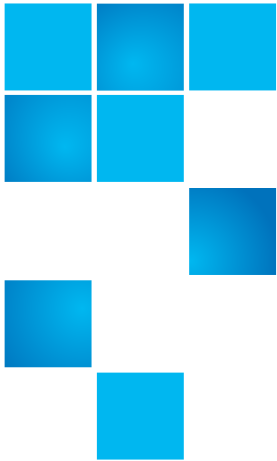

Chapter 1

About This Guide and Your Product

This guide contains information necessary for site planning prior to the installation of the Scalar i6000. This guide is intended for anyone interested in learning about or anyone that needs to know how to plan for the installation of a Scalar i6000 library.

Caution: Be sure to read all operating instructions in this manual and in the *System, Safety, and Regulatory Information Guide* before operating this product.

This guide is intended to be used by system administrators, information technology professionals, and Quantum professional services and service personnel who will be involved with the installation of the library.

Product Safety Statements

This product is designed for data storage and retrieval using magnetic tape. Any other application is not considered the intended use. Quantum will not be held liable for damage arising from unauthorized use of the product. The user assumes all risk in this aspect.

This unit is engineered and manufactured to meet all safety and regulatory requirements. Be aware that improper use may result in bodily injury, damage to the equipment, or interference with other equipment.

WARNING: Before powering on or using this equipment, read *THE System, Safety, and Regulatory Information Guide*. Keep the Guide for future reference.

Mercury Statement



Projectors, LCD displays, and some multifunction printers may use lamp(s) that contain a small amount of mercury for energy-efficient lighting purposes. Mercury lamps in these products are labeled accordingly. Please manage the lamp according to local, state, or federal laws. For more information, contact the Electronic Industries Alliance at www.eiae.org. For lamp-specific disposal information check www.lamprecycle.org.

Disposal of Electrical and Electronic Equipment

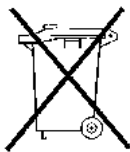

This symbol on the product or on its packaging indicates that this product should not be disposed of with your other waste. Instead, it should be handed over to a designated collection point for the recycling of electrical and electronic equipment. The separate collection and recycling of your waste equipment at the time of disposal will help to conserve natural resources and ensure that it is recycled in a manner that protects human health and the environment. For more information about where you can drop off your waste equipment for recycling, please visit our Web site at: <http://qcare.quantum.com> or contact your local government authority, your household waste disposal service or the business from which you purchased the product.

Product Regulatory Model Number

The Scalar i6000 model number is: SCi2000

Explanation of Symbols and Notes

The following symbols appear throughout this document to highlight important information.

WARNING: INDICATES A POTENTIALLY HAZARDOUS SITUATION WHICH, IF NOT AVOIDED, COULD RESULT IN DEATH OR BODILY INJURY.

Caution: Indicates a situation that may cause possible damage to equipment, loss of data, or interference with other equipment.

Note: Indicates important information that helps you make better use of your system.

Other Documents You Might Need

The following documents are also available for this product. These documents can be found on the product CD or at www.quantum.com/support.

- *Scalar i6000 User's Guide* (6-66879-xx)
- *Quantum Intelligent Libraries Basic SNMP Reference* (6-01159-xx)
- *System, Safety, and Regulatory Information Guide* (6-00618-xx)

Note: Release Notes are also available for this product. The Release Notes describe changes to your system or firmware since the last release, provide compatibility information, and discuss any known issues and workarounds. The Release Notes can be found in the product box or at www.quantum.com/support.

Contacts

Quantum Corporate Headquarters

Quantum Corporation Headquarters
1650 Technology Drive, Suite 700
San Jose, CA 95110-1382

Getting More Information or Help

More information about this product is available on the Service and Support Web site at www.quantum.com/support. The Service and Support Web site contains a collection of information, including answers to frequently asked questions (FAQs). You can also access software, firmware, and drivers through this site.

For further assistance, or if training is desired, contact Quantum:

Global Call Handling

1-800-284-5101

For additional contact information:

www.quantum.com/support

To open a Service Request:

www.quantum.com/osr

Quantum Corporation

www.quantum.com

Training

Important: Register for and complete the online training for the Scalar i6000 in order to make the best use of your product.

The online training is available at www.quantum.com/ServiceandSupport/StorageCareLearning/Index.aspx



Chapter 2 Description

The Scalar i6000 library automates the retrieval, storage, and control of cartridges. The cartridges are mounted and retrieved from tape drives using a robotic assembly that is driven by application software from the host without operator intervention. The library is designed for ease of installation, configuration, and field upgrades.

In December, 2011, the library robotics were redesigned. The robot redesign accommodates either a single robot or dual robotics. The original robot hardware is referred to as Gen 1 robot; the new robot hardware is referred to as Gen 2 robot.

In March 2013, the library electronics were redesigned, including a new second generation Management Control Blade (MCB 2). The electronics redesign is referred to as Gen2 Electronics and is required for to support new features, such as Active/Active operation for Dual Robots and the High-Density Expansion Module (HDEM).

In June 2015 new Series 3 modules were released for the Control Module (CM3), Drive Ready Expansion Module (DREM3) and Storage Expansion Module (SEM3). These new modules are capable of a higher number of drive support than the previous modules:

- CM3: Supports up to 18 tape drives
- DREM3: Supports up to 24 tape drives
- SEM3: Does not support tape drives but can be converted to a DREM3
- RPM (DREM3): Still supports 12 drives, no expanded drive support

The Series 3 modules can be mixed and matched with older modules. However, the CM3 and DREM3 increased drive support requires gen2 robotics, gen2 electronics and minimum i12.2.1 code. If these gen2 and code requirements are not met, the CM3 and DREM3 can still be used but will operate in 12 drive mode.

Note: Series 2 and earlier modules cannot be converted to Series 3 modules.

For Gen2, dual-robot systems using i11, the two robots work in an active/active manner, where both robots are available to perform all move commands and operations. Also new for i11 is the availability of High-Density Expansion Modules (HDEM) that allow for increased media storage.

Dual robotics libraries require special modules on either end called parking modules, which house the robots when not in use. See [Dual-Robot Configurations and Parking Modules](#) on page 25 for more information.

You can upgrade an existing single robotics library (Gen 1 or Gen 2) to a Gen 2 dual-robotics library. See [Dual Robotics Upgrade Requirements](#) on page 97 for specific upgrade requirements. You can also upgrade a Gen 1 library to a Gen 2 library (see [Gen 2 Single Robotics Upgrade Requirements](#) on page 98).

The library can be installed on a solid or a raised floor. The library has a standard 19-inch rack footprint and can be placed in a standard server rack space. Access is from doors located at the front and back so the library can be placed with either side against a wall, or between racks.

You can tell which generation robot you have via the library user interface. The library displays which generation of robot hardware is installed. Select **Monitor > System** from the menu, click the **Robot** tab, and look in the **Generation** column (see [Figure 1](#)).

Additionally, the main screen of the library user interface displays how many robots are installed (see [Figure 23](#) on page 45). If you do not see this information displayed when viewing the physical library, you have a Gen 1 robot.

Figure 1 Robot Tab

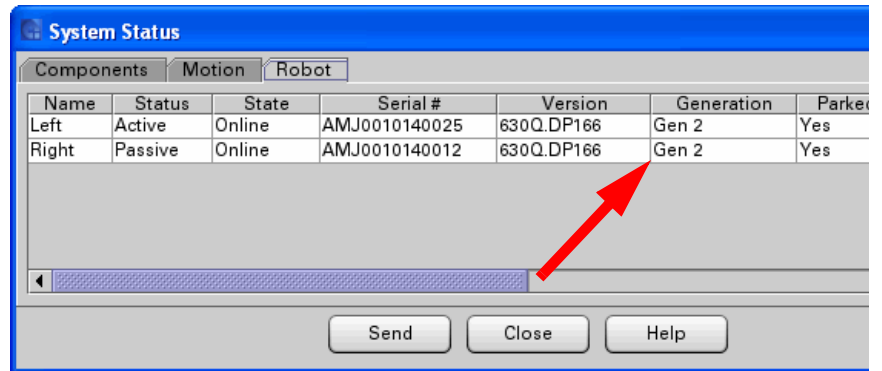

To determine what generation electronics your library is running, select Monitor > System from the menu, click the Components tab and look in the Name column. If you have MCB2 and RCU2, you have gen2 electronics. Any other MCB or RCU level means gen1 electronics.

Figure 2 Components Tab

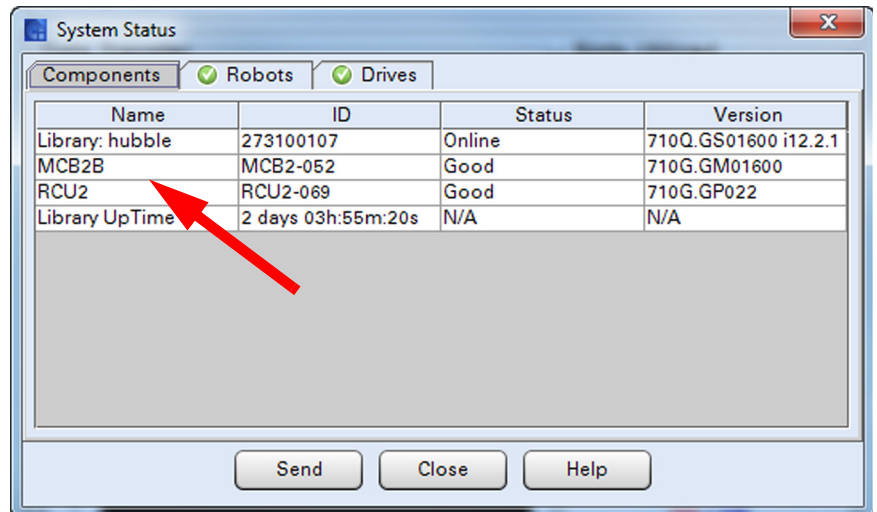

In March of 2013, a High Density Expansion Module (HDEM) was made available to provide increased storage capabilities. A single HDEM can hold up to 720 total slots; 540 on two independent carrousel's and 240 on the front door.

The maximum library can be configured to accommodate from 100 LTO cartridges to 7,146 LTO cartridges (for a single-robot library) or 7,224 LTO cartridges (for a dual-robot library). For libraries containing high-

density expansion modules, the maximum capacities are 12,006 LTO cartridges (for a single-robot library) or 11,760 LTO cartridges (for dual-robot libraries).

This chapter provides a description of the following features and components:

- [Control Module](#) on page 9
- [Expansion Modules](#) on page 18
- [Dual-Robot Configurations and Parking Modules](#) on page 25
- [Library Management Module](#) on page 29
- [I/O Management Unit](#) on page 31
- [Robot](#) on page 34
- [Import/Export Station](#) on page 34
- [Tape Drives and Media](#) on page 35
- [WORM Support](#) on page 36
- [Magazines](#) on page 37
- [Cartridges](#) on page 38
- [Power System](#) on page 39
- [Host Attachment](#) on page 40
- [Operator Panel](#) on page 43
- [Aisle Lights](#) on page 46
- [Webcam](#) on page 46
- [Tower Barcode Scanner](#) on page 47
- [Managing Your Library Remotely](#) on page 47
- [Slot Capacity](#) on page 54
- [Encryption and Key Management Solutions](#) on page 55

Control Module

All libraries contain a control module. A single-frame library consists of a control module only. The control module manages library operations via the library management module and includes an operator panel touch screen for local operator use. For more information, see:

- [Library Management Module](#) on page 29
- [Operator Panel](#) on page 43

The control module also contains all of the other components common to expansion modules, including:

- [Import/Export Station](#) on page 34
- [Tape Drives and Media](#) on page 35
- [Magazines](#) on page 37
- [Cartridges](#) on page 38
- [Power System](#) on page 39

The control module always occupies module position 1 in the library. (In dual-robot configurations, the left parking module is in position 0.)

Figure 3 Front and Back View
of the Control Module

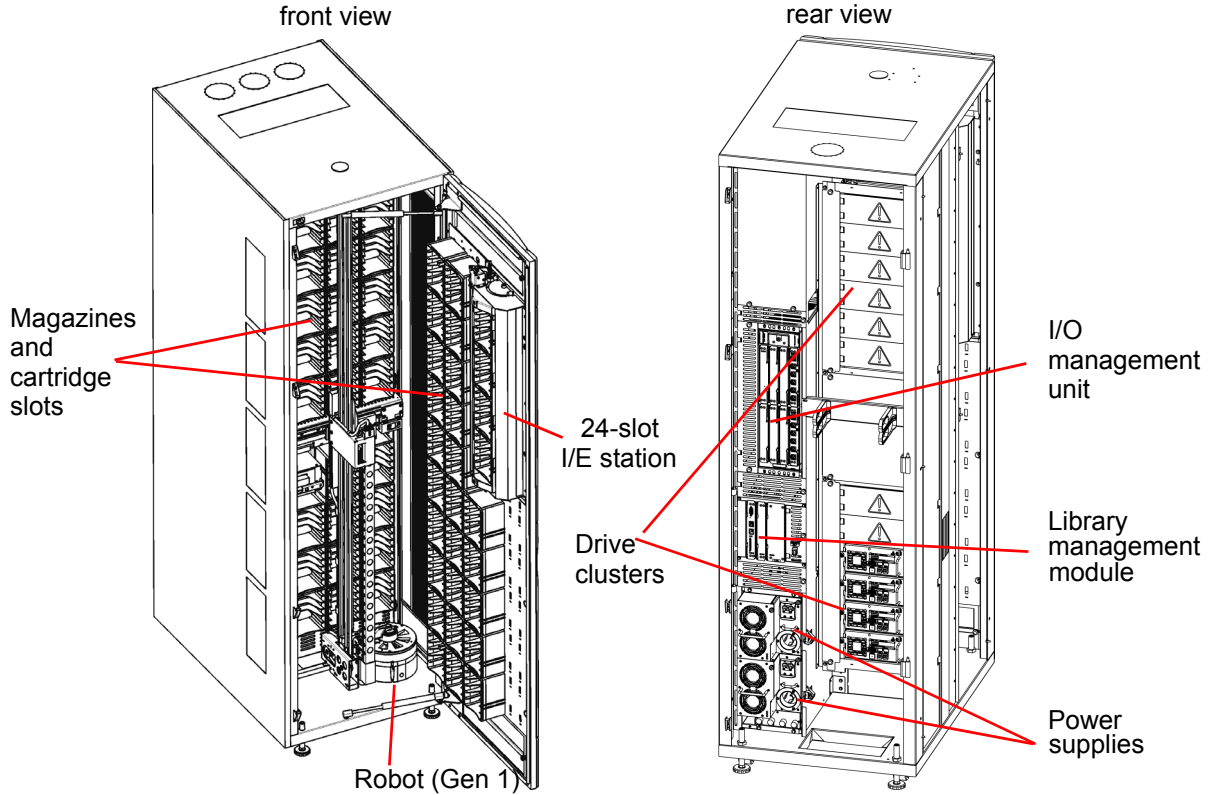
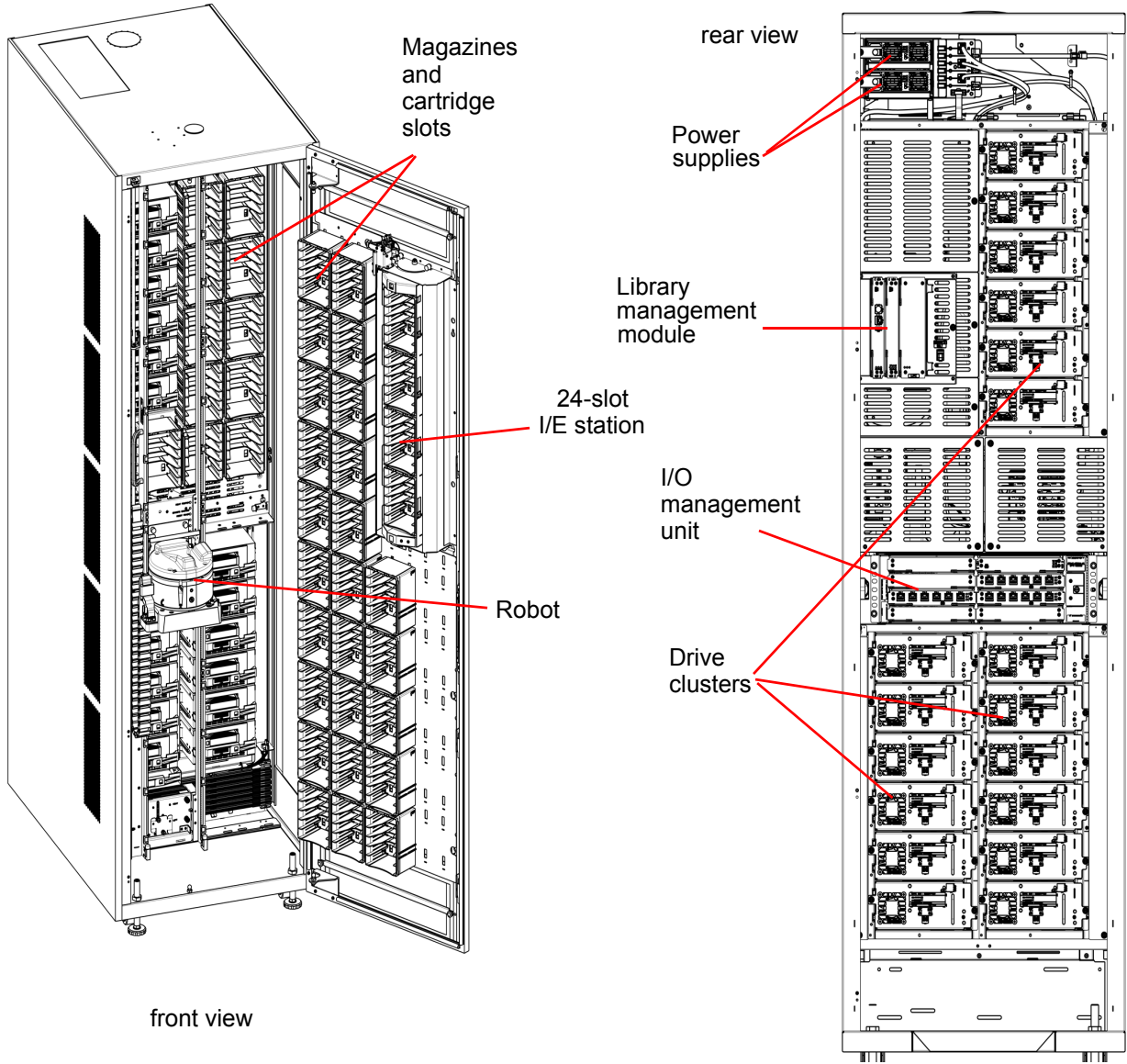

Figure 4 Front and Back View
of a Series 3 Control Module
(CM3)



Note: A control module can only contain a 24-slot I/E station.

Figure 5 Magazine and Drive
Location in the Single-Robotics
Control Module

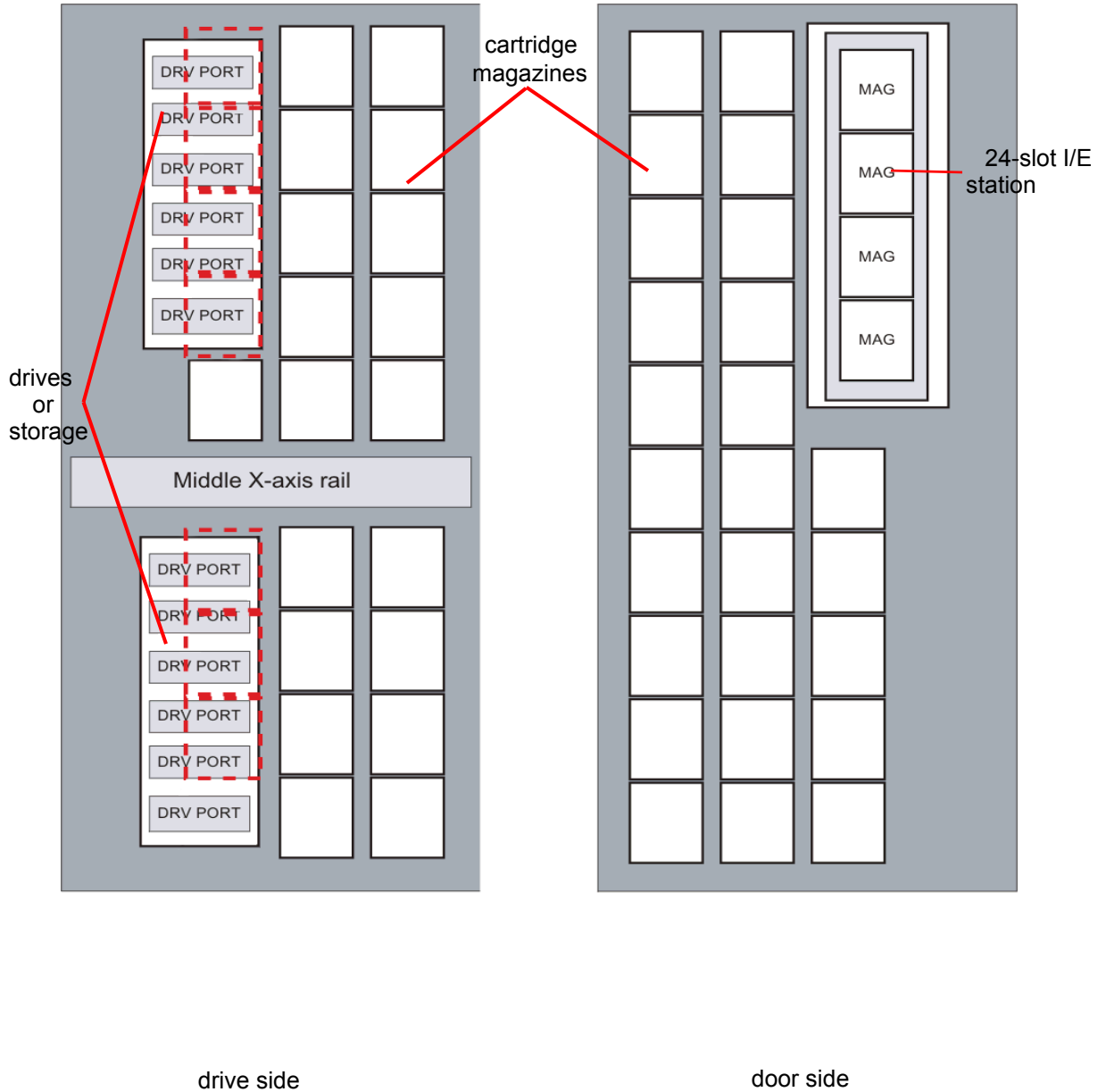
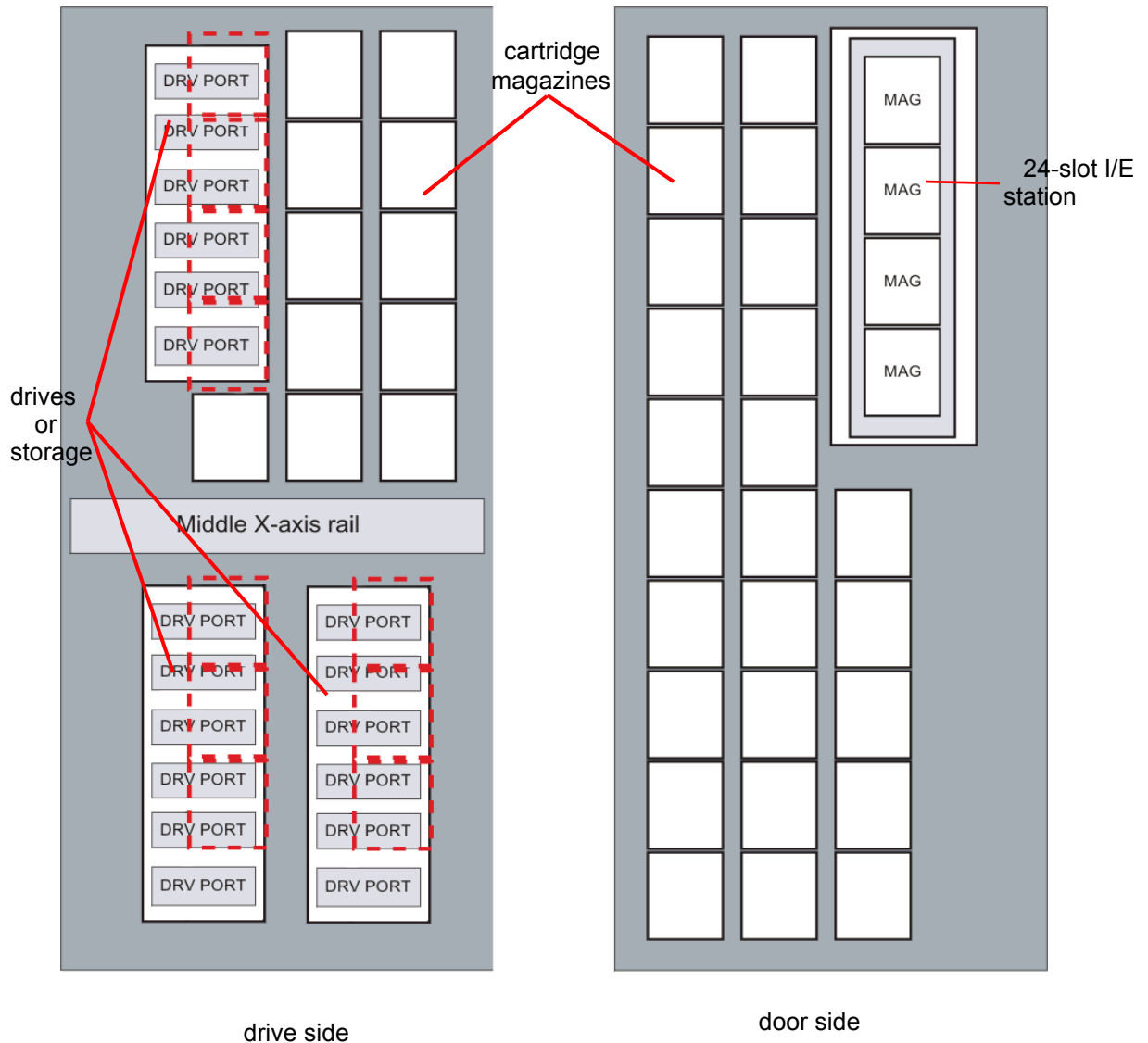

Figure 6 Magazine and Drive
Location in the Single-Robotics
Series 3 Control Module



Note: Series 3 modules require i12.2.1 firmware as well as gen2 electronics and robotics.

Figure 7 Magazine and Drive
Location in the Dual-Robotics
Control Module

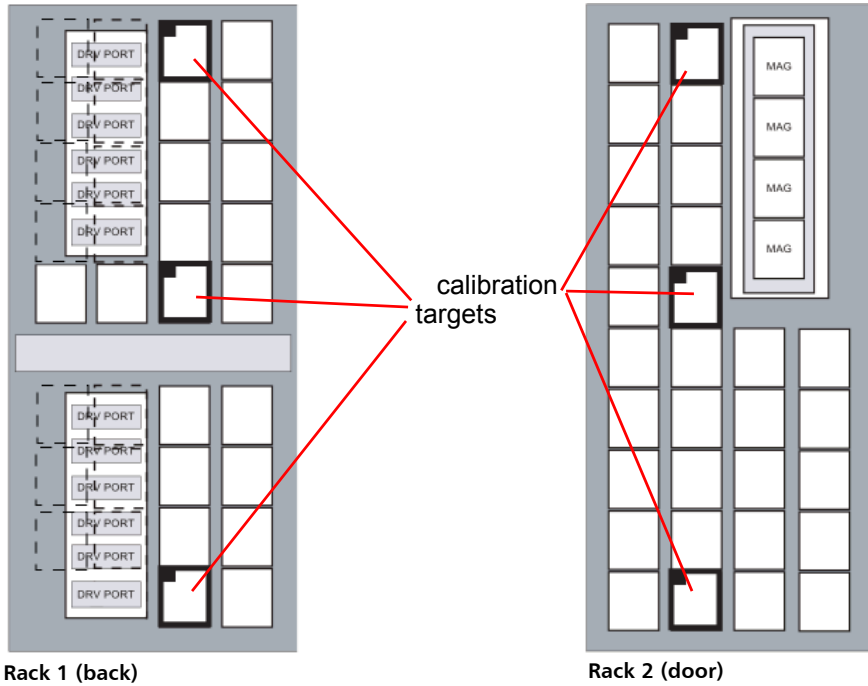
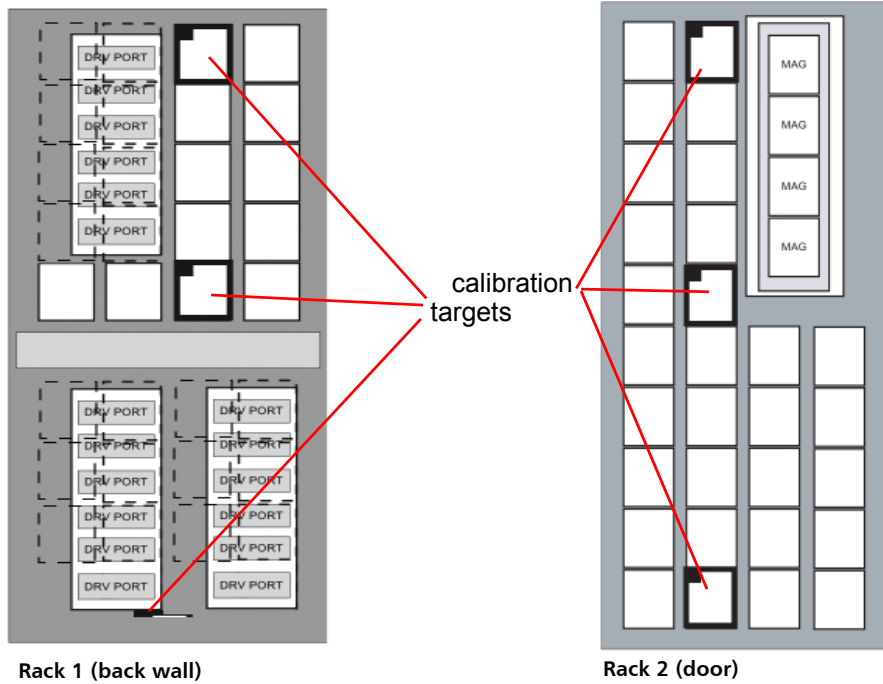

Figure 8 Magazine and Drive
Location in the Dual-Robotics
Series 3 Control Module



Note: Series 3 modules require i12.2.1 firmware as well as gen2 electronics and robotics.

Control modules in dual-robotics libraries can take advantage of two columns of storage (up to 14 additional magazines) that are unavailable in single-robotics configurations. [Figure 9](#) shows where the additional magazines are located.

Figure 9 Additional Storage Available in Dual-Robotics Control Module

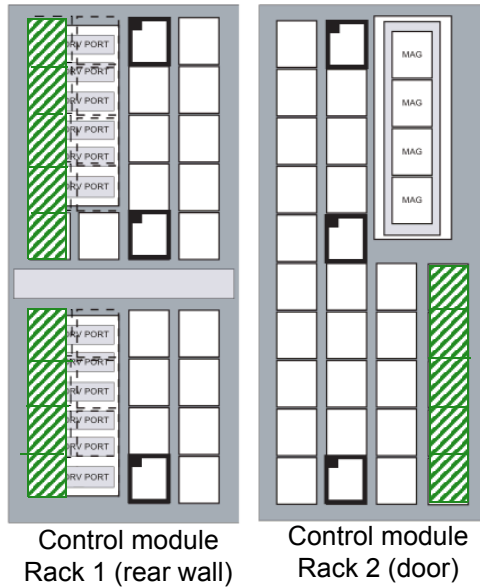
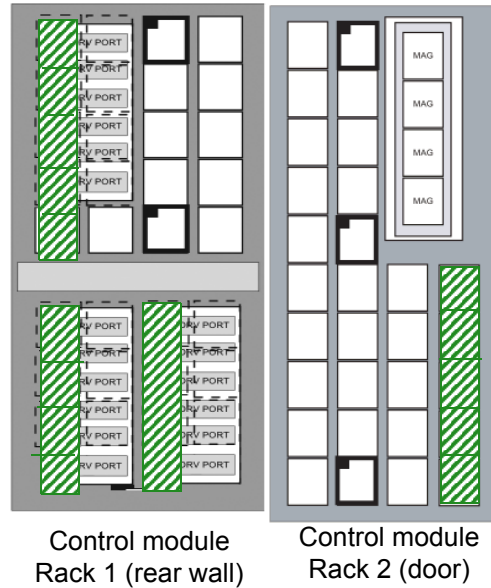

Figure 10 Additional Storage
Available in Dual-Robotics
Series 3 Control Module



Extra magazine slots are only available if the drive slots are not in use.

Note: Series 3 modules require i12.2.1 firmware as well as gen2 electronics and robotics.

Expansion Modules

Expansion modules enable the library to expand by adding space for tape drives, an I/E station, and storage. Each expansion module from 96 to 780 LTO cartridge slots depending on the number of tape drives installed and whether an I/E station is installed. See [Figure](#) on page 21 for location information.

Quantum offers three different expansion modules (EMs) used with the Scalar i6000:

- **Drive Ready Expansion Module (DREM):** This module is required when drives will be installed into the module. It has the power and network components needed to support tape drives. The DREM supports up to 24 tape drives and up to 456 cartridge slots, but the slots are reduced when drives or an I/E station are installed in the module.

A new Series 3 DREM (DREM3) module was introduced with the i12.2.1 code base. DREM3 modules installed in libraries with gen2 robots, gen2 electronics and running 12.2.1 or higher code will support up to 24 tape drives.

- **Storage Expansion Module (SEM):** This module is used when drives will not be installed in the module and high-density is not needed. While the SEM does not support drives, it can be field upgraded to a DREM if drives are needed in the future. The SEM supports up to 456 cartridge slots, but the slots are reduced when an I/E station is installed in the module.

A new Series 3 SEM (SEM3) module was introduced with the i12.2.1 code base. SEM3 modules can be field converted to a DREM3.

- **High-Density Expansion Module (HDEM):** This module is used when it is important to minimize the floor space. The HDEM supports up to 780 cartridge slots, but does not support drives. The slots are reduced when an I/E station is installed in the module.

Note: When referencing expansion modules in all Scalar i2000/i6000 documentation it includes all three module types: drive-ready, storage and high-density. When referencing standard expansion modules, it includes just the drive-ready and storage expansion modules.

Parking Modules are also used to expand the library, but these modules are only used when the dual-robot is installed

In Gen 1 single-robot configurations, the library's maximum configuration includes up to 11 expansion modules for a total of 12 frames. In Gen 2 single-robot configurations, the library's maximum configurations includes up to 15 expansion modules for a total of 16 frames. In Gen 2 dual-robot configurations, the library's maximum configuration includes up to 15 expansion modules for a total of 17 frames (including the LPM and CM). Expansion modules can be added only to the right of the control module for all configurations and the LPM is always to the left of the CM.

For Gen 2 dual-robot configurations that include HDEMs, the library's maximum configuration includes up to 14 HDEMs and a single standard expansion module to serve as the right parking module. This is because an HDEM cannot be used as a parking module.

For the i11 release, standard expansion modules in positions 9 through 16 are no longer restricted to storage-only. Now all standard expansion modules can accommodate the following functional units:

- [I/O Management Unit](#) on page 31
 - [Control Management Blade](#) on page 31
 - [Fibre Channel I/O Blades](#) on page 32
 - [Ethernet Expansion Blades](#) on page 32
- [Robot](#) on page 34
- [Import/Export Station](#) on page 34 (optional)
- [Tape Drives and Media](#) on page 35 (drives are optional)
- [Magazines](#) on page 37
- [Cartridges](#) on page 38

- [Power System](#) on page 39 (required only if drives are installed; if an expansion module contains only cartridges, all power is derived from the control module).

Figure 11 Front and Internal Side View - Expansion Module with 72-slot I/E station

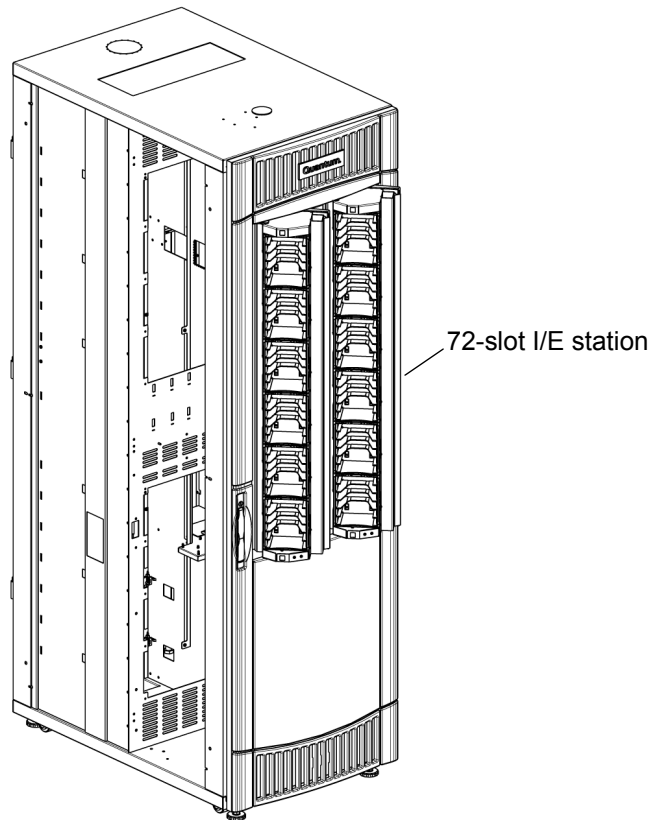

Figure 12 Magazine and Drive Locations in SEM with a 24-slot I/E Station

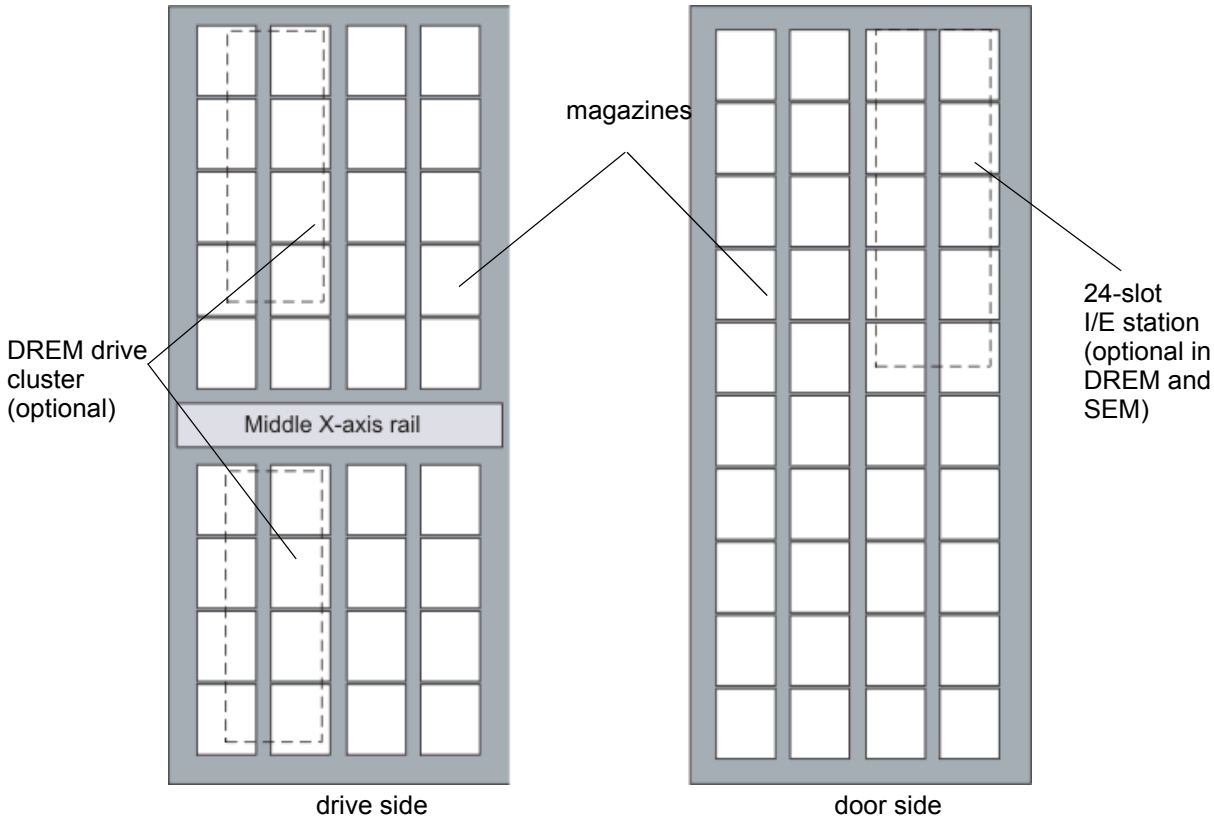
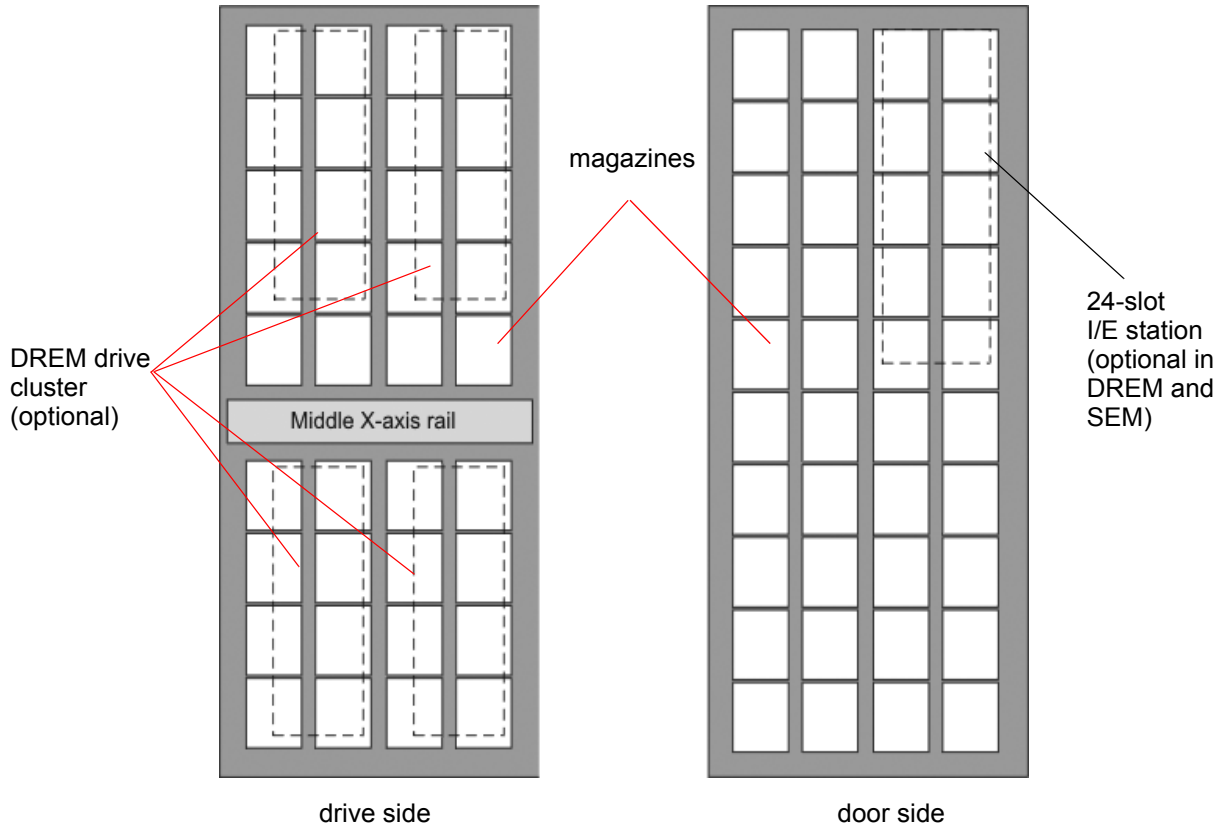

Figure 13 Magazine and Drive Locations in Series 3 SEM with a 24-slot I/E Station



Note: Series 3 modules require i12.2.1 firmware as well as gen2 electronics and robotics.

Figure 14 Magazine and Drive Locations in Standard Expansion Modules with a 72-slot I/E Station

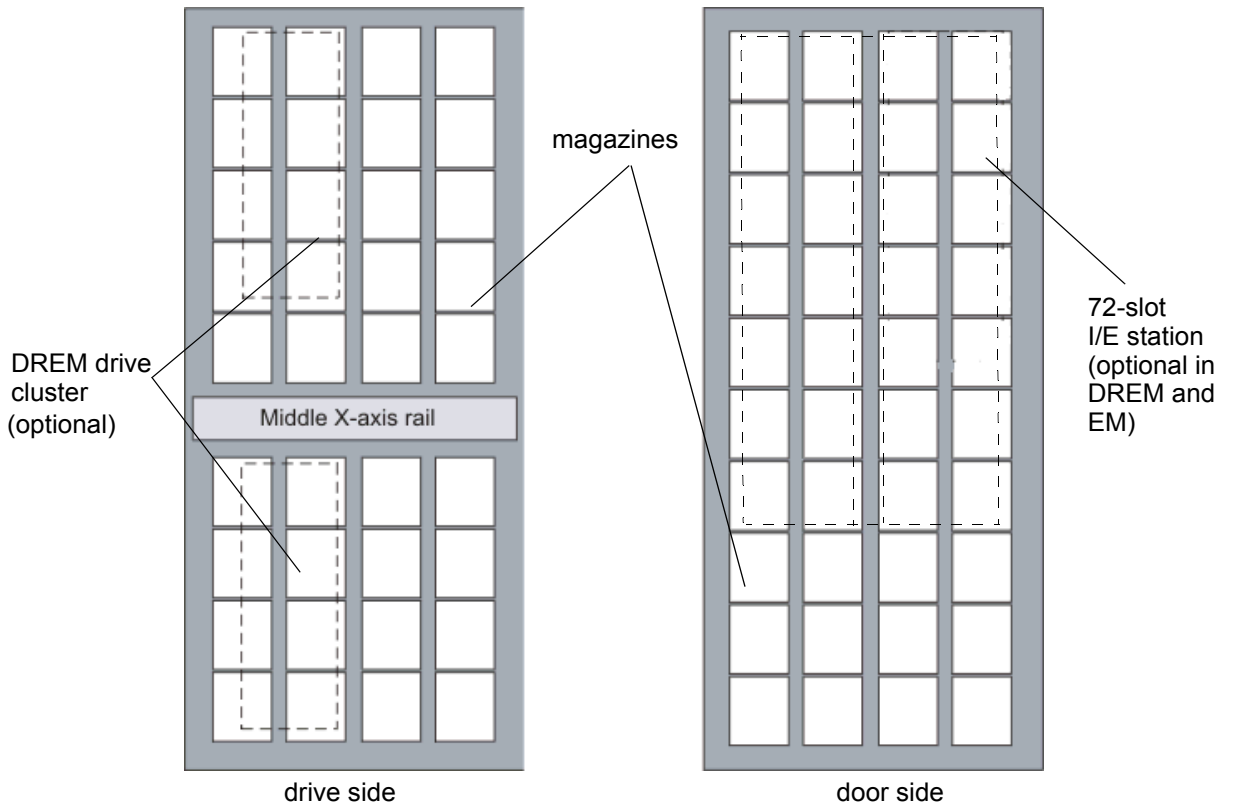
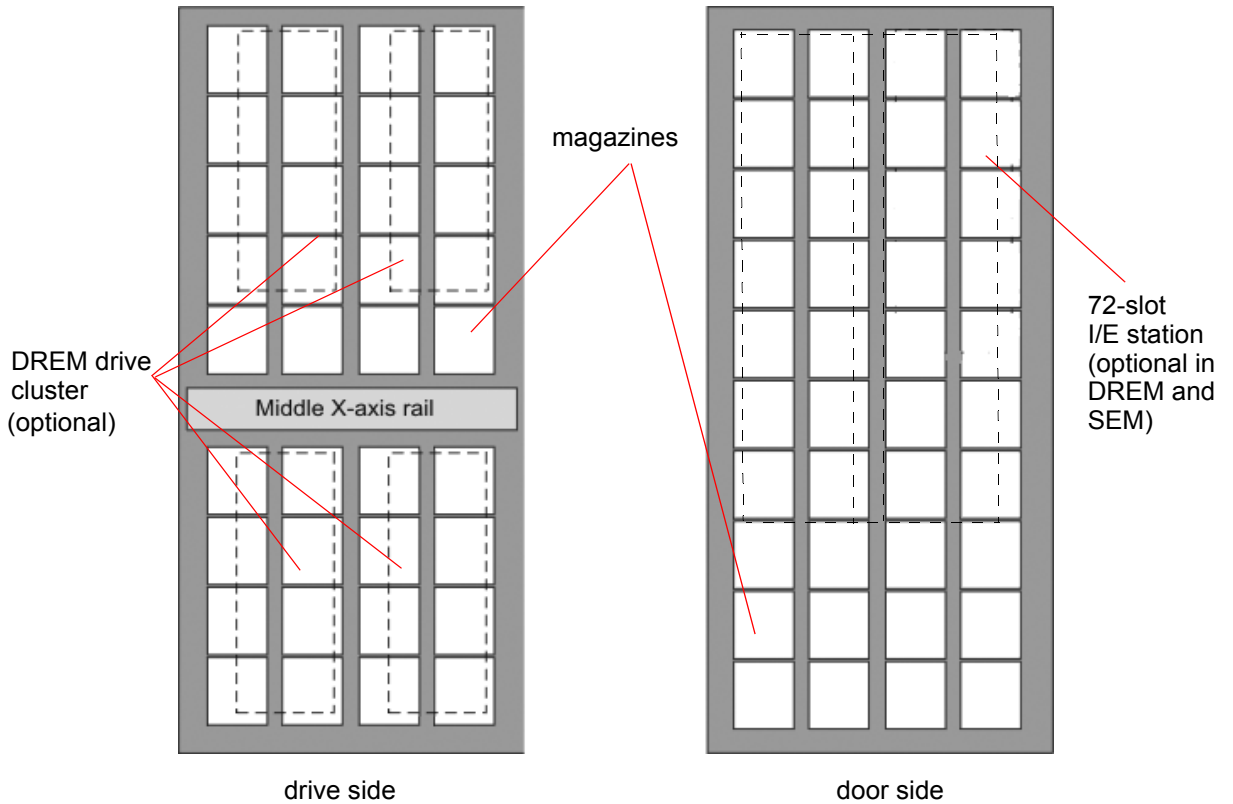

Figure 15 Magazine and Drive Locations in Series 3 Standard Expansion Modules with a 72-slot I/E Station



Note: Series 3 modules require i12.2.1 firmware as well as gen2 electronics and robotics.

Dual-Robot Configurations and Parking Modules

A dual-robotics library requires Gen 2 robotics hardware. A dual-robot library requires, at a minimum, a control module, a left parking module, and a right parking module. See [Figure 16](#).

For a dual-robot library that includes an HDEM, it requires, at a minimum, a left parking module (shipped with dual-robots), a control module, an HDEM and a right parking module.

The left and right parking modules have the same size and appearance as standard expansion modules, but they function differently. Each parking module contains a “parking space” in which the respective left or right robot resides when not in use. The parking space occupies four magazine columns which cannot be used for storage.

The left parking module is located to the left of the control module in position zero. It is referred to in the user interface as “module 0.” The left parking module does not contain tape drives, I/E stations, or power supplies. The control module supplies its power. If you are upgrading to dual-robotics, you will receive a left parking module to add onto your existing system (the LPM and second robot ship together when ordering the Dual Robot option). This increases your system size, so you must take this into account when planning for an upgrade.

The right parking module is a converted SEM or DREM and is the right-most module in the system. As with standard expansion modules, in i11 the right parking module may contain a maximum of 12 drives, power supplies, and up to one 24-slot I/E station no matter how many frames make up the library. The only restrictions are that right parking modules may not contain a 72-slot I/E station and an HDEM cannot be used as a right parking module.

If you are upgrading a single-robot library to a dual-robot library, the existing right-most expansion module can, in most cases, be converted into a right parking module. However, if the existing right-most expansion module contains a 72-slot I/E station or is an HDEM, you will need another module to be added to the right of your system which becomes the right parking module. If space considerations prohibit the addition of another module, then the right-most module will be swapped with another module in the library that does not contain a 72-slot I/E station. For more information on upgrading an existing

library to dual robotics, see [Dual Robotics Upgrade Requirements](#) on page 97.

Figure 16 Dual Robotics Library - No HDEM

Side panels, doors, and door posts have been removed for clarity.

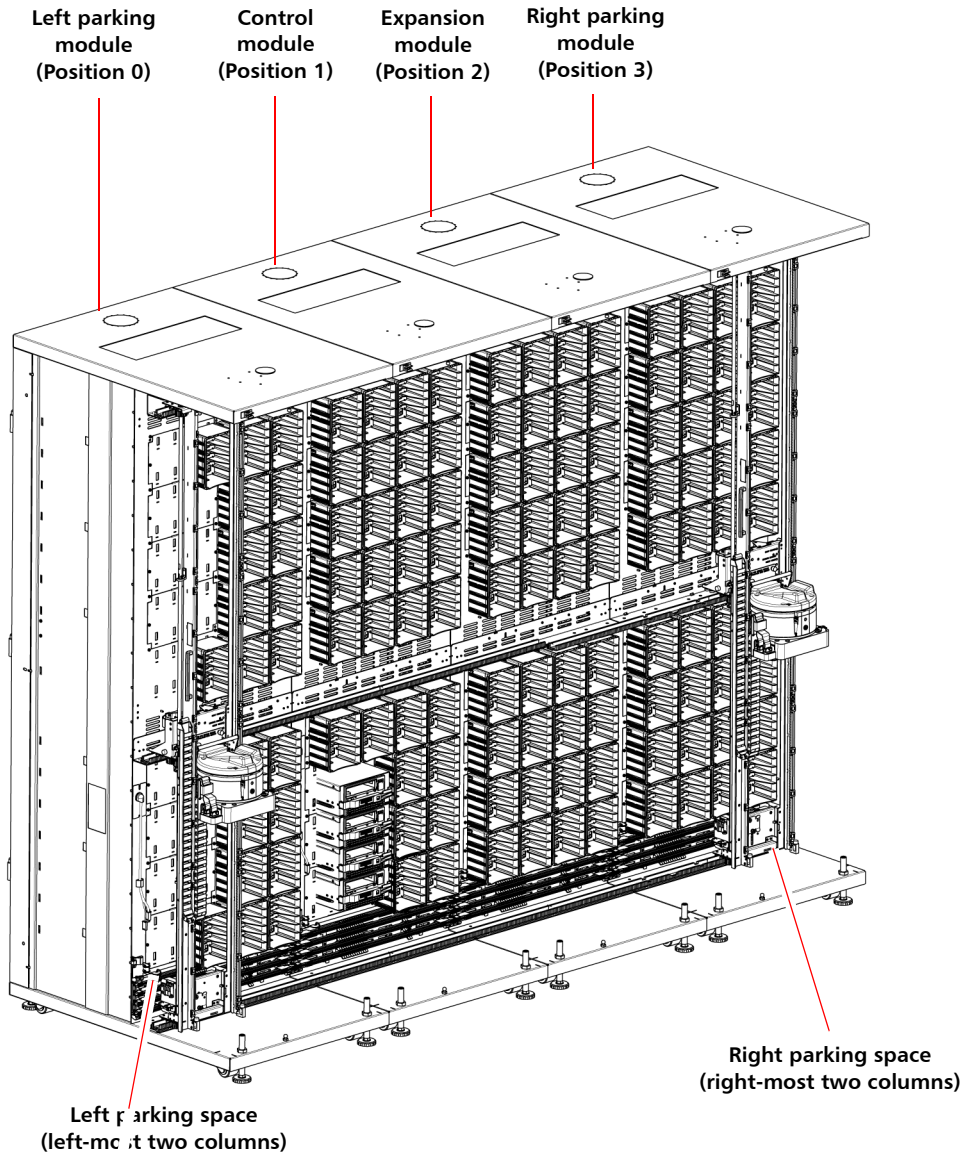

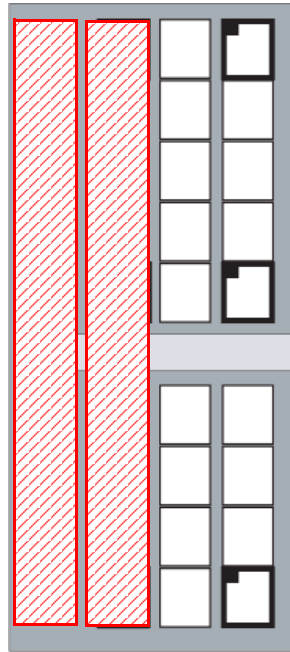
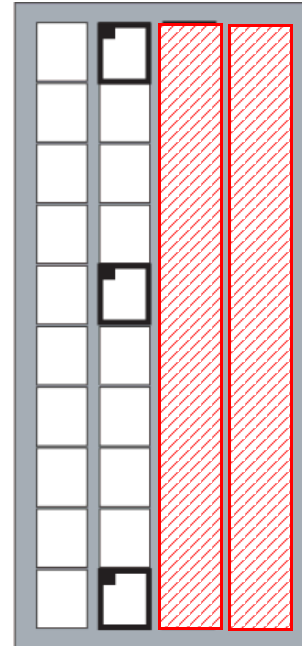

Figure 17 Left Parking Module Slot Configuration (Dual-Robot Only)

 = Columns unavailable for storage



Rack 1 (rear wall)



Rack 2 (door)

Figure 18 Right Parking
Module Slot Configuration
(Dual-Robotics Only)

 = columns
unavailable
for storage

Optional
DREM drive
clusters

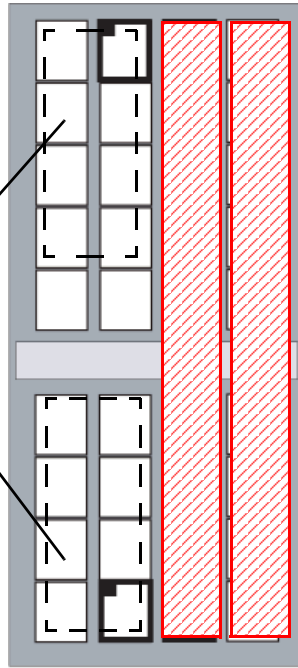

Rack 1 (rear wall)

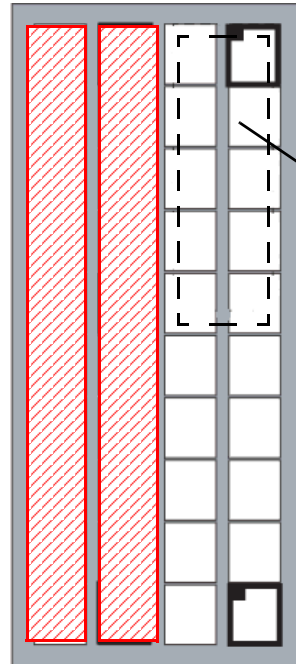

Optional
24-slot
I/E station
for DREM
or SEM

Rack 2 (door)

Library Management Module

The library management module is located in the control module. It controls system hardware and enables external devices to perform configuration and obtain system status. The library management module contains the following boards:

- **Management control blade (MCB)** - Manages the library, passing commands to and from the robotics control unit as well as the storage area network (SAN) components. It is also the interface for managing the library remotely and handles encryption key management (EKM).

Note: An MCB 2.0 is required for any system to upgrade to i11.x.

- **Robotics control unit (RCU)** - Controls the picker and accessor functionality.

Note: An RCU 2.0 is required for any Gen 2 system to upgrade to i11.1.1 or greater.

- **Library motor drive (LMD) (Gen 1 libraries only)** - Distributes power to the picker along with the X and Y-axis circuits. It also distributes power to the touch screen.
- **Library power control (LPC) (Gen 2 libraries only)** - Distributes power to the robot through the power rails. It also distributes power to the touch screen.

Figure 19 Library Management
Module Boards

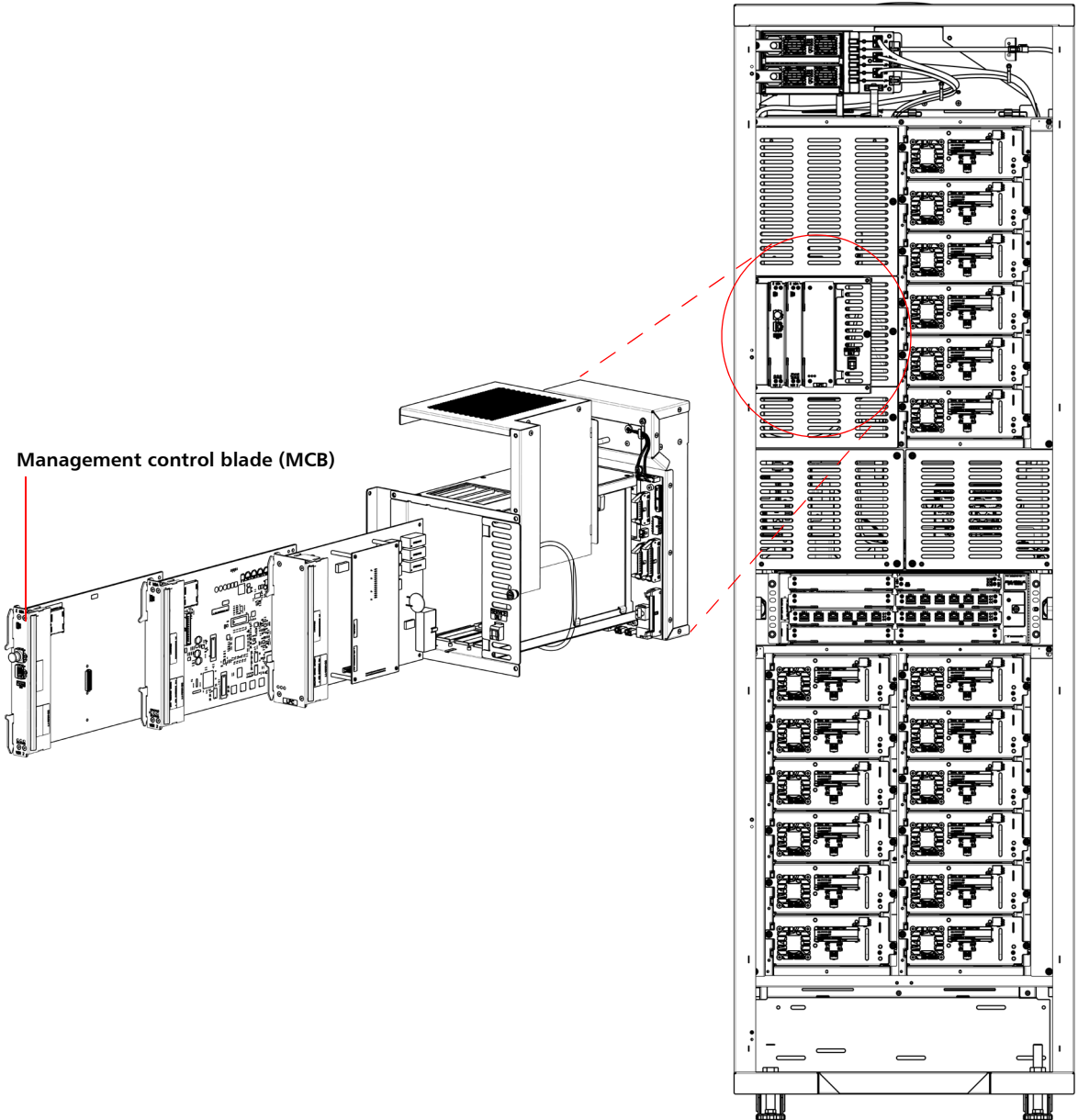

I/O Management Unit

The I/O management unit is an optional component that provides connectivity and data path management to a SAN fabric and the hosts. The I/O management unit houses up to four FC I/O blades, which provide FC connections for the Fibre Channel drives in the module. The I/O management unit also houses up to two Ethernet Expansion blades, which handle internal Ethernet communication between the MCB and HP LTO-5 and LTO-6 drives. (The control module and each of the expansion modules can contain up to 12 FC drives.) The I/O management unit performs all tape drive and library host communication functions in a library that is attached to a SAN.

I/O management units may be installed in the control module and expansion modules. The I/O management unit supports the following blades:

- [Control Management Blade](#)
- [Fibre Channel I/O Blades](#)
- [Ethernet Expansion Blades](#)

When FC I/O blades or Ethernet Expansion Blades (EEBs) are installed in the library, the following rules regarding control management blades (CMBs) apply:

- Any module (including the control module) that contains FC I/O blades or EEBs must also contain a CMB.
- A CMB must be installed in the control module and all modules that contain drives. Modules that don't contain drives, blades or network chassis will contain drive and network jumpers that maintain communications between the MCB located in the control module and the modules that contain drives, FC I/O blades and EEBs.

Control Management Blade

The CMB performs unit status monitoring including power and I/O present conditions, and internal network switch functions connecting I/O blades with the library management module.

Fibre Channel I/O Blades

There is a single Fibre Channel (FC) I/O blade type: 7404 that auto-negotiates up to 4 Gbps. Each FC I/O blade has an embedded controller that provides connectivity and features that enhance the performance and reliability of tape operations. Each blade provides two host communication ports and four connection ports to drives.

- Fibre Channel LTO-1, LTO-2, LTO-3, LTO-4, LTO-5, and LTO-6 drives can be connected to drive-aggregating Fibre Channel I/O blades or directly attached to a host.

Note: If library firmware is at level 630Q or later, DLT tape drives are no longer supported.

- We recommend that you connect directly to the host FC to take advantage of the maximum possible throughput.

Ethernet Expansion Blades

The EEB provides the option for Ethernet connectivity to each HP LTO-5 or LTO-6 drive (for MCB-to-drive communication purposes only). The EEB provides a control path to the drive for commands as well as facilitates taking drive logs and downloading drive firmware. Each EEB has 6 Ethernet ports to allow attachment to 6 HP LTO-5 or LTO-6 drives. The EEB provides Ethernet connectivity to the library's internal Ethernet only and should not be connected to an external Ethernet source.

Figure 20 I/O Management Unit

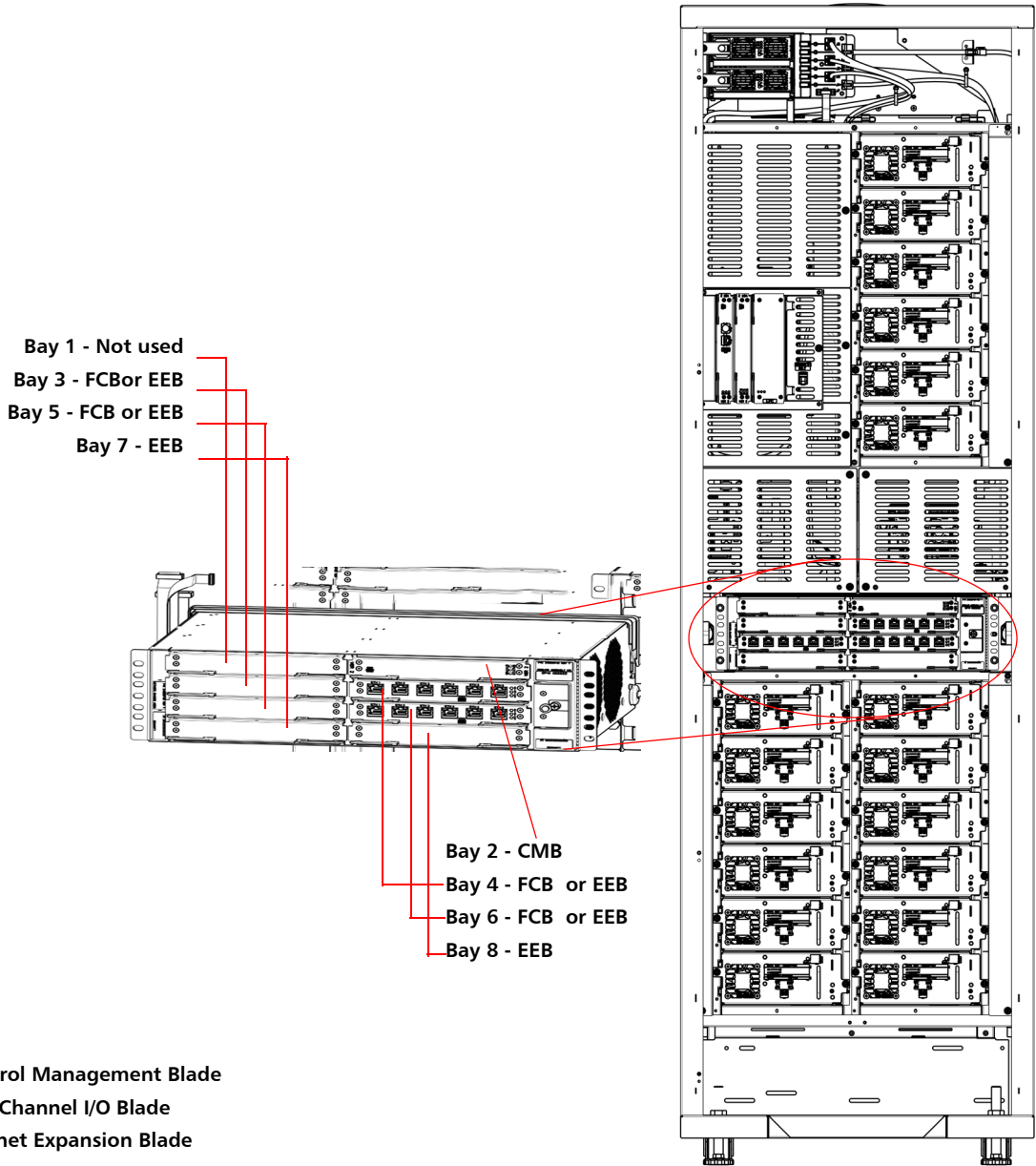

CMB = Control Management Blade
FCB = Fibre Channel I/O Blade
EEB = Ethernet Expansion Blade

Robot

The robot moves cartridges between storage cells, tape drives, and the I/E station. A picker is used to get or put cartridges in a storage cell or a tape drive slot. The picker moves along an X and Y axis and can pivot 180°. A barcode scanner on the picker assembly identifies cartridges located in storage cells.

The library can be configured for either one or two robots. See [Dual-Robot Configurations and Parking Modules](#) on page 25 for more information.

Import/Export Station

I/E stations enable you to import and export cartridges without interrupting normal library operation. There are two types of I/E stations: 24-slot and 72-slot.

Each 24-slot I/E station has a capacity of 24 LTO cartridges that are located in four removable magazines. The 72-slot I/E station consists of two side-by-side 36-slot I/E stations that can operate independently or as a single 72-slot I/E station. Each 36-slot I/E station provides I/E capacity of 36 LTO cartridges in six removable magazines.

The I/E station is installed on the front of the control module or any of the standard expansion modules or HDEMs and a 24-slot I/E station can be installed in a right parking module. See [Figure 3](#) on page 10 and [Figure 3](#) on page 10 to see the location of the I/E station.

Note: The I/E station cannot be configured as a storage location, but can be part of a logical division of library resources known as partitions.

Note: The maximum number of I/E element addresses in any partition is 240. This includes both physical slots and extended I/E virtual slots.

Tape Drives and Media

Note: Library firmware versions 630Q (i10) and later do not support DLT tape drives, media, or magazines. If you upgrade to these library firmware versions, make arrangements to remove and/or replace all DLT tape drives, media, and magazines in your library. If you want to continue to use DLT tape drives and media, your library firmware must be at version 617G.GS01001 (i8.4) or earlier.

The tape drives are enclosed in a universal drive sled. The library supports the following tape drives types:

- IBM LTO-1 or LTO-2 LVD–SCSI
- IBM LTO-1, LTO-2, LTO-3, LTO-4, LTO-5, and LTO-6 FC Multi-mode
- HP LTO-3, HP LTO-4, LTO-5, and LTO-6 FC Multi-mode

For i11, the control module and the drive ready expansion modules have two sets of upper and lower drive clusters. Each library must have at least one tape drive. Each drive cluster can house up to six tape drives for a total of 24 drives per module. While additional drives can be added to any DREM in the configuration, the maximum number of drives is 192. In dual robotics systems, the left parking module cannot contain drives.

Note: Standard expansion modules in positions 9 through 16 are no longer storage-only expansion modules.

Note: The term *drive cluster* defines a grouping of up to six tape drives below or above the middle X-axis rail. See [Figure 3](#) on page 10 for the locations of drive clusters.

Even though tape drives can be installed in any module (except LPM and HDEM), it is recommended that tape drives be installed in bottom-to-top order in the control module before any are added to other expansion modules. Once the control module has 18 drives installed from bottom to top, you should move to bottom drive position of a drive-ready expansion module. Refer to [LTO Drive Requirements and Compatibility](#) on page 80 for LTO drive requirements.

Note: When you add drives, you lose storage slots.

Note: The Scalar i6000/i500 library configured with tape drives over Native Fibre Channel connectivity, allows the utilization of all tape drives simultaneously without loss of performance when utilizing direct connectivity of the Tape Drives with Customer SAN Fabric and Backup Servers environment. The compatibility matrix between LTO tape drives, Scalar Tape Libraries and SAN Switches can be found at <http://www.quantum.com/swcompguide.aspx>.

WORM Support

The Scalar i6000 library supports WORM (write once, read many) technology in LTO-3, LTO-4, LTO-5, and LTO-6 tape drives. WORM requirements include:

- Cartridges
- Firmware
- WORM-supported LTO-3 tape drives
- WORM-supported LTO-4 tape drives
- WORM-supported LTO-5 tape drives
- WORM-supported LTO-6 tape drives

WORM allows non-erasable data to be written once and provides extra data security by prohibiting accidental data erasure. When the library firmware and WORM-supported LTO-3 or, LTO-4, LTO-5, or LTO-6 tape drive code are installed on a library with LTO-3 or, LTO-4, LTO-5, or LTO-6 tape drives, the WORM feature is supported whenever the operator uses WORM cartridges.

Magazines

The magazine is a storage assembly that installs on the drive side or door side of the control module, expansion module, or parking module. It contains the cartridge slots and provides flexibility when adding storage cartridges to a module. The LTO magazines hold six cartridges. Magazines are removable and may have moved during shipment; make sure they are seated.

Table 1 LTO Cartridge Capacities in Library Modules

Type	Magazine Capacity	Cartridge Capacity
Magazine (LTO)	--	6
Control module (single-robotics) ^a	36 min/51 max	216 min/306 max
Control module (dual-robotics) ^a	42 min/64 max	252 min/384 max
Standard Expansion module ^c	48 min/76 max	288 min/456 max
Drive Ready Expansion Module ^b	16 min/76 max	96 min/456 max
High-Density Expansion Module ^c	102 min/130 max	612 min/780 max
Left parking module (dual-robotics) ^d	38	228
Right parking module (dual-robotics) ^e	12 min/38 max	72 min/228 max

a. Control module: The minimum is based on having 18 drives and one 24-slot I/E station installed. The maximum is based on having one drive and one 24-slot I/E station installed.

b. Drive Ready Expansion module: The minimum is based on having 24 drives and one 72-slot I/E station and 24 drives installed. The maximum is based on having no drives or an I/E station installed.

c. Standard and HDEM: The minimum is based on one 72-slot I/E station and 12 drives installed. The maximum is based on having no drives or an I/E station installed.

d. Left parking module: No drives or I/E stations are allowed. The left parking space takes up 4 columns of storage. There are six empty magazines located in the unusable 4 columns which are used for calibration only. These six magazines are not counted toward the total capacity.

e. Right parking module: The minimum is based on having 12 drives and one 24-slot I/E station installed. The maximum is based on no drives or I/E station installed. The right parking space takes up 4 columns of storage.

Each magazine has a barcode label that the scanner reads for identification and inventory. An optional, snap-on dust cover is available for the magazines to be used for external storage. The magazines with the dust cover have interlocked stacking that enables easier storage of the media when they are removed from the library.

Cartridges

Cartridges are stored in magazines within the library and identified by an operator-attached, machine-readable barcode label. See [Barcode Requirements](#) on page 82 for additional information.

Figure 21 Example of LTO Cartridge Insertion into a Magazine

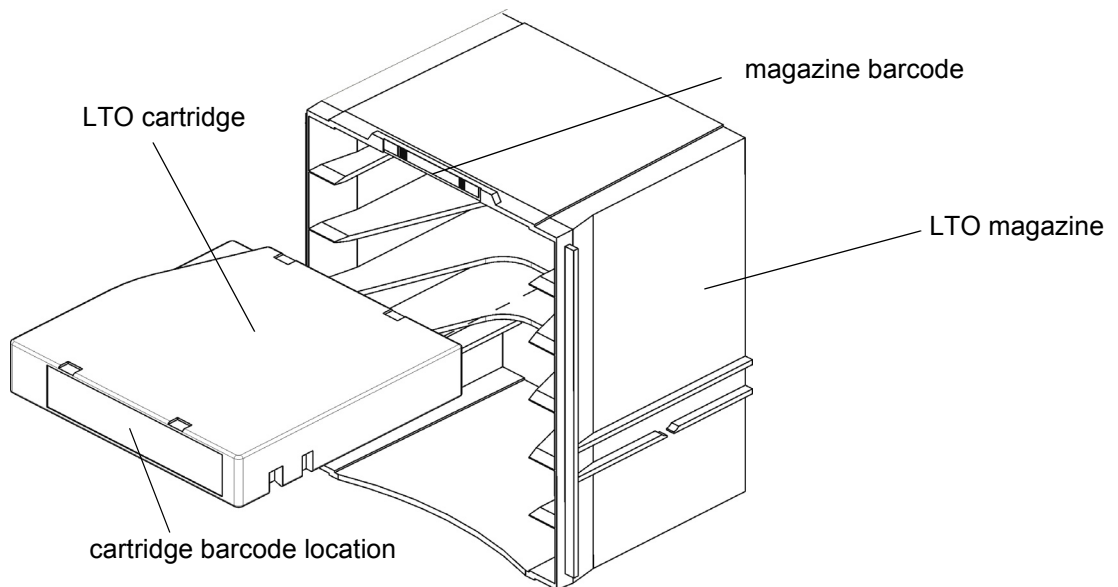

Power System

The library supports single and redundant power configurations. The single configuration has either a single AC or DC line input with a single DC power supply. The redundant configuration has either a dual AC or DC line input with dual DC power supplies. You can hot swap a power supply if you have a redundant power supply. You can hot add a second power supply.

Note: Power supplies cannot be mixed with other power supplies. AC power supplies and power distribution units must be housed in an AC power chassis and DC power supplies and power distribution units must be housed in a DC power chassis.

The power system may consist of the following:

AC Power	DC Power
Power Supply	Power Supply
Power Distribution Unit	Power Distribution Unit
Power Cord	Not Available (See <i>Scalar i6000 Maintenance Guide</i> for details)

A single power switch, located on the front door of the control module, turns on and off all power for the control module and attached expansion modules. Each power distribution unit has a second circuit breaker, located in the rear of the module, that controls the module power supply output. The power supply has three LEDs that provide status information. The power system also has four fuses for system protection.

The control module and all expansion modules or right parking modules that contain drives must contain a power system. If an expansion module or right parking module contains only cartridges, its power is derived from the control module and a power system is not needed.

Host Attachment

Hosts can be attached to the library in the following ways:

- [Library Control Path](#) on page 40
- [Data Path](#) on page 41
- [Path Failover](#) on page 42
- [Network](#) on page 43

Library Control Path

The library control path is used to send SCSI commands to the library. The Scalar i6000 offers several different control path options:

- **HP and IBM LTO-5 or LTO-6 Native Fibre Channel (Ethernet Expansion Blade included)** — A tape drive hosts the library control path and forwards media changer commands to the library controller. Commands for both the tape drive and the library are received by the drive. This shared SCSI protocol link uses the Fibre Channel connection on the drive so a dedicated port for library control is not needed. You must have at least one HP or IBM LTO-5 or LTO-6 FC drive installed in the library. The drive must be attached to an Ethernet Expansion blade. For more information, see the *Scalar i6000 User's Guide*.

Note: HP LTO-5 and LTO-6 drives support control path connectivity in version i8 and higher.

Note: IBM LTO-5 and LTO-6 drives support control path connectivity in version i12 and higher and only with Gen2 libraries (robot and electronics).

- **Path Failover (previously Native Storage Networking (nSNW) (Ethernet Expansion Blade Attached)** — Path failover can be used to provide redundant or multiple control paths.

A tape drive hosts the library control path and forwards media changer commands to the library controller. Commands for both the tape drive and the library are received by the drive. This shared

SCSI connection uses the Fibre Channel connection on the drive so a dedicated port for library control is not needed.

Path failover licenses can be added to a library that has IBM or HP nFC LTO-5 or higher drives. If control path failover is used, a minimum of two path failover licenses are required. The control path fails over to the second port on a drive and then to another drive that is configured for control path failover. If a customer is interested in minimizing the ports used on their FC switches, the second port on the drives do not need to be used. In this case, the failover would go directly from the primary drive to the failover drive.

For more information, see the *Scalar i6000 User's Guide*. For more information, see the *Scalar i6000 User's Guide*.

- **Storage Networking (SNW) (Fibre Channel I/O Blade Attached)** — The host connects to the library through a dedicated 4 Gb FC port on an FC I/O blade. However, using I/O blades in the data path prevents the use of EEBs and path failover licenses.

A second, dedicated 4 Gb FC port on the FC I/O blade can be used for control path failover. Drives must be SNW tape drives and attached to an FC I/O blade. For more information, see the *Scalar i6000 User's Guide*.

- **Library MCB Port** (*not available for versions i10.x or higher*) — The MCB has one dedicated 1 Gb FC port that can be used for host connectivity. This port can be used even if the nSNW or SNW options are purchased.

Note: This port is not supported in version i10.x or higher. If upgrading a library to i10.x, a newer generation drive or I/O blade may need to be ordered to provide a supported library control path.

Data Path

The data paths are used to send commands and data to tape drives. The Scalar i6000 offers three different data path options:

- **Native Fibre Channel (nFC) (Direct Attach)** — Drives use a single FC port per LTO tape drive. The FC interfaces vary by LTO generation:
 - LTO-6 uses 8 Gb
 - LTO-5 uses 8 Gb

- LTO-4 uses 4 Gb
- LTO-3 uses 2 Gb and 4 Gb
- LTO-2 uses 1 Gb and 2 Gb
- LTO-1 uses 1 Gb
- **Path Failover (Previously Native Storage Networking (nSNW) (Ethernet Expansion Blade Attached)** — Applies to nSNW HP LTO-5 FC or LTO-6 drives connected to an Ethernet Expansion blade only. The native 8 Gb FC port on the drive is used. These drives also support basic or advanced data path failover using a second FC port on the tape drive, so if you want to use data path failover, two ports per drive are required.
- **Storage Networking (SNW) (Fibre Channel I/O Blade Attached)** — The data paths connect to the library through a dedicated 4 Gb FC port on an FC I/O blade. Drives must be SNW tape drives and attached to an FC I/O blade. Up to four tape drives can be supported per FC I/O blade.

Path Failover

Path Failover (previously Native Storage Networking or nSNW) is a set of features that increase control path and data path availability. There are three path failover options:

- Advanced Path Failover for IBM LTO-5 and higher drives
- Advanced Path Failover for HP LTO-6 and higher drives
- Basic Path Failover for IBM and HP LTO-5 and higher drives

Advanced path failover supports multiple FC fabrics and requires a specific Quantum driver installed on host computers.

Basic path failover either uses 1) NPIV technology supporting a single FC fabric with no driver needed or 2) the path management solution of the application.

All three path failover options support library control path and/or data path failover. IBM and HP LTO-5 and higher drives have two FC ports on the drive. When a path failover license is added to the library, the second FC port on one drive is enabled. The second port is needed for data path failover but is not necessary for control path failover.

The control path fails over to the second port on a drive and then to another drive that is configured for CPF. If a customer is interested in

minimizing the ports used on their FC switches, the second port on the drives do not need to be used. In this case, the failover would go directly from the primary drive to the failover drive.

Network

The library management interface uses an 10/100 Ethernet port on the MCB for network connectivity. For i11.x, the MCB 2.0 is available with a 1 Gb Ethernet port and for i12.x, the MCB 2.0 has two 1 Gb Ethernet ports. This port is shared for connectivity of the remote user interface and any encryption key management solution used for library managed encryption.

Operator Panel

The operator panel is located on the front of the control module and consists of indicators and a touch screen (see [Figure 22](#)). The buttons are for library control and power while the indicators provide library status.

Figure 22 Operator Panel

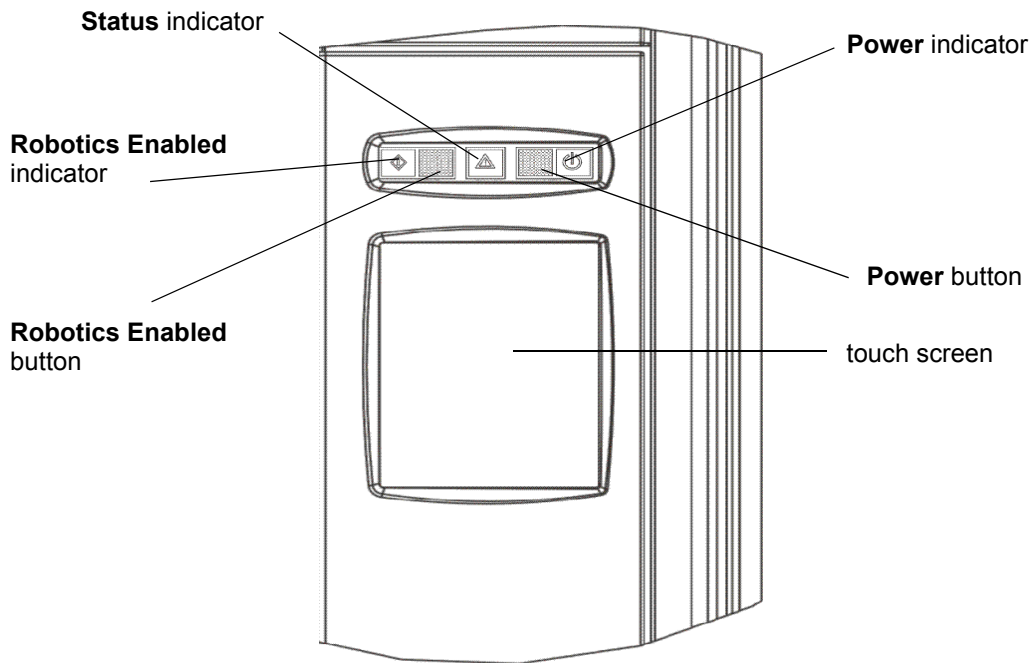

The touch screen is the library navigation point and provides access to the Library Management Console (LMC), which is shown in [Figure 23](#) on page 45. The LMC consists of five primary areas:

- Title bar—provides the library name
- Menu bar—provides menu access to all library management commands
- Tool bar—provides quick access to the most commonly executed functions
- Library information panel—provides real-time library information
- Overall system status—provides real-time status information for the six subsystems of the physical library

Figure 23 Library Management
Console

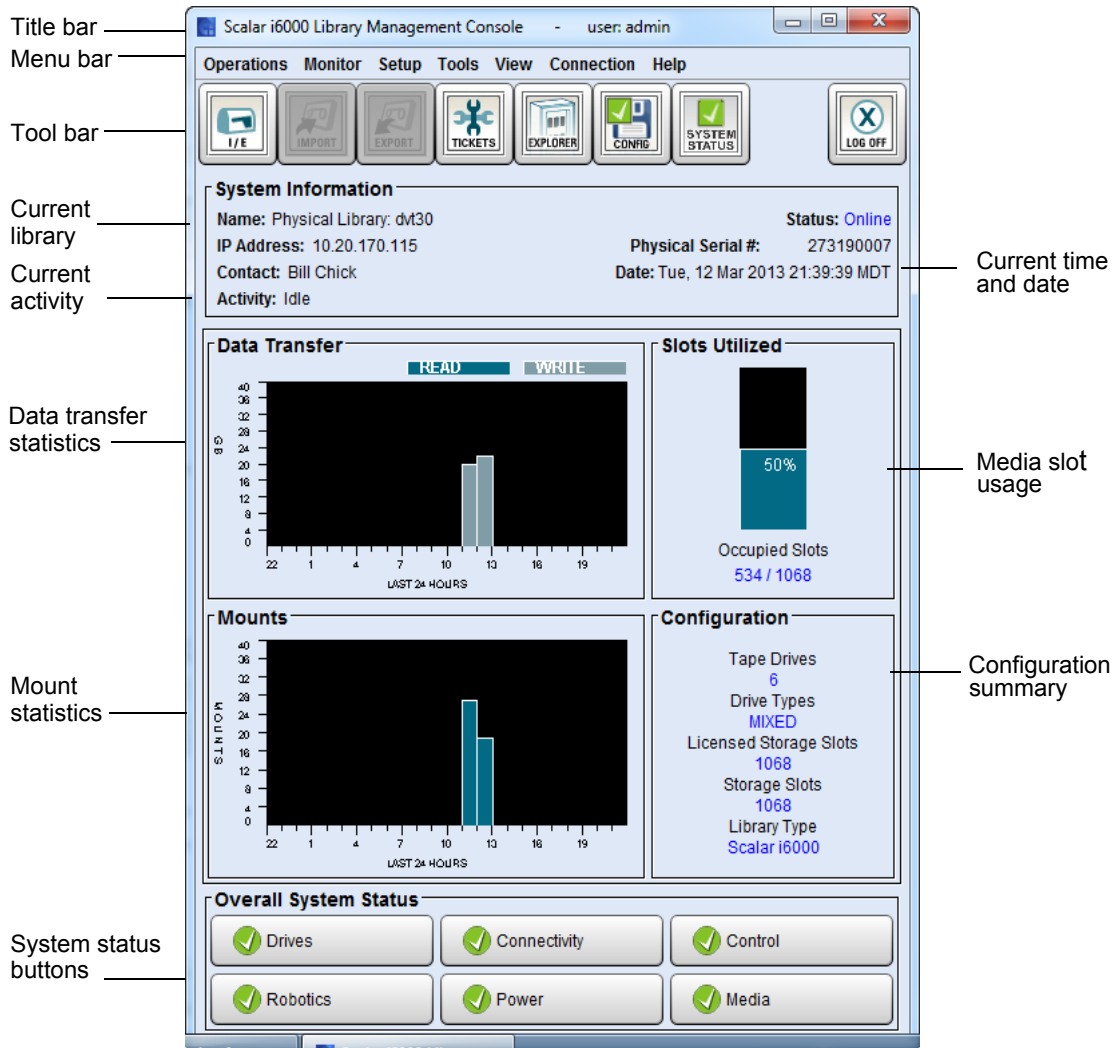

For additional information on the touch screen and the LMC, refer to the *Scalar i6000 User's Guide*.

Aisle Lights

Aisle lights are used to illuminate the inside of a module and can be used in conjunction with a webcam to monitor activity within the library. Aisle lights can be configured to turn on at various time intervals and for specific durations. If a webcam is installed, the aisle lights will turn on automatically when the webcam is accessed and turn off when stopped.

Note: Aisle lights are available for i2000/i6000 libraries. However, not all i2000's have the necessary hardware features. The Control Module serial number in your i2000/i6000 library configuration must be at least 203102253 or begin with 263.

Note: For the aisle lights to automatically come on when the webcam is accessed, the minimum library firmware code is i10.2 (640Q.GS08801).

Note: An aisle light cannot be in the same frame as a webcam.

Webcam

A webcam is an optional component that can be installed to any expansion module within a library. In conjunction with aisle lights, a webcam is used to monitor activity within the library.

Requirements for installing a webcam include:

- External 110v power source
- Cable from external Ethernet port to webcam interface module
- Aisle lights
- Scalar i6000, Gen2 robotics, version 10.2 or higher
- Fire Suppression port not already in use

Note: It is recommended that version i10.2 be used so that the aisle lights turn on automatically when the webcam is activated. Previous versions will require that the aisle lights be turned on independently from the webcam.

Note: Webcams are available for i2000/i6000 libraries. However, not all i2000's have the necessary hardware features. The Control Module serial number in your i2000/i6000 library configuration must be at least 203102253 or begin with 263.

Tower Barcode Scanner

The new Tower Barcode Scanner is an optional upgrade for the HDEM. One scanner can be installed in each HDEM and is used to inventory cartridges residing on the tower. The scanner improves operations by conducting all inventory operations on the tower independent of the rest of the library. Thus all tower inventory operations (e.g., library initialization, cartridge imports, or cartridge moves) have little or no impact on other library operations.

Managing Your Library Remotely

The library can be managed locally or remotely using the Library Management Console (LMC). Locally, the LMC is displayed on the touch screen (operator panel) on the front of the library. Remotely, the LMC is accessed through a Web browser. The interface is identical to the front panel interface, using Java RMI communications. This enables the library to provide end-users with status changes and events as they occur.

At a high level, remote access can be managed using security functions embedded within the Scalar i6000. This includes authentication via individual user names/passwords and access control settings which

enable or disable specific access protocols to limit what type of remote management is possible.

In addition to this, most customers should have one or more firewalls in place to govern remote access. As with any Internet accessible service, the LMC requires a communication path so that data can be transmitted between clients and the Scalar i6000. How this communication path is managed depends on the user's configuration. The following three scenarios describe typical configurations.

Scenario 1: Internet-based clients managing multiple internal Scalar i6000s

For most organizations, a single administrator will not be managing all storage resources. In this instance, as shown in [Figure 24](#), multiple administrators and even Quantum service personnel may be asked to remotely access Scalar i6000s.

Figure 24 Multiple Libraries, Firewall with VPN

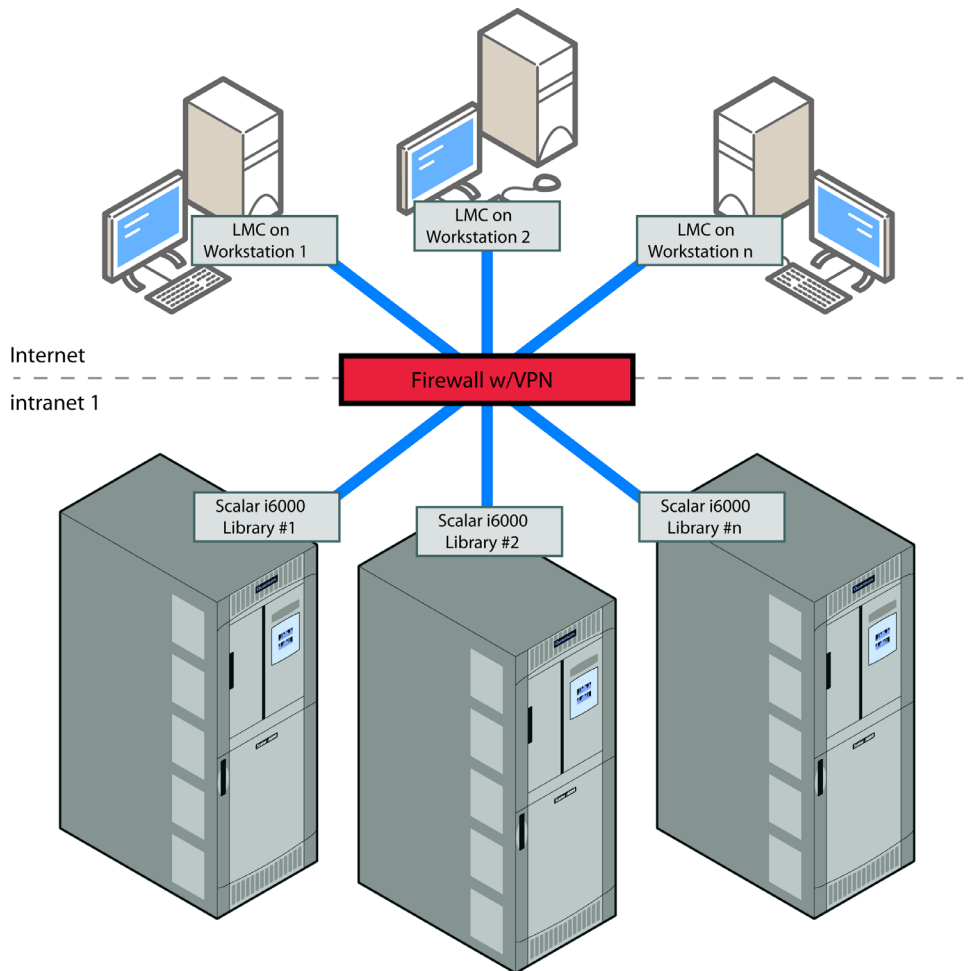

In the scenario shown in [Figure 24](#), Quantum highly recommends using virtual private network (VPN) software to control access to the Scalar i6000. VPNs offer authentication and encryption services to protect data transmissions and determine who can access a corporate network. By using VPN, the LMC client appears to be inside the firewall and have unrestricted access when communicating with the library.

While a VPN is recommended, customers could use port blocking to provide access. In this instance, the following firewall requirements must exist:

- Inbound access to port 1099 (Java RMI server port)
- Stateful access control — used with most Web technologies (for example, Web mail) to enable a server to communicate with the client that started the connection

Scenario 2: Internal clients accessing a single library across an internal firewall

Another common configuration is one in which multiple internal clients manage a single Scalar i6000. For example, [Figure 25](#) shows network operation/data center staff providing monitoring services of specific resources. Administrators are inside the corporate firewall, but security considerations necessitate an additional firewall between administrators and the resources they manage.

Figure 25 Single Library,
Firewall with Port Forwarding

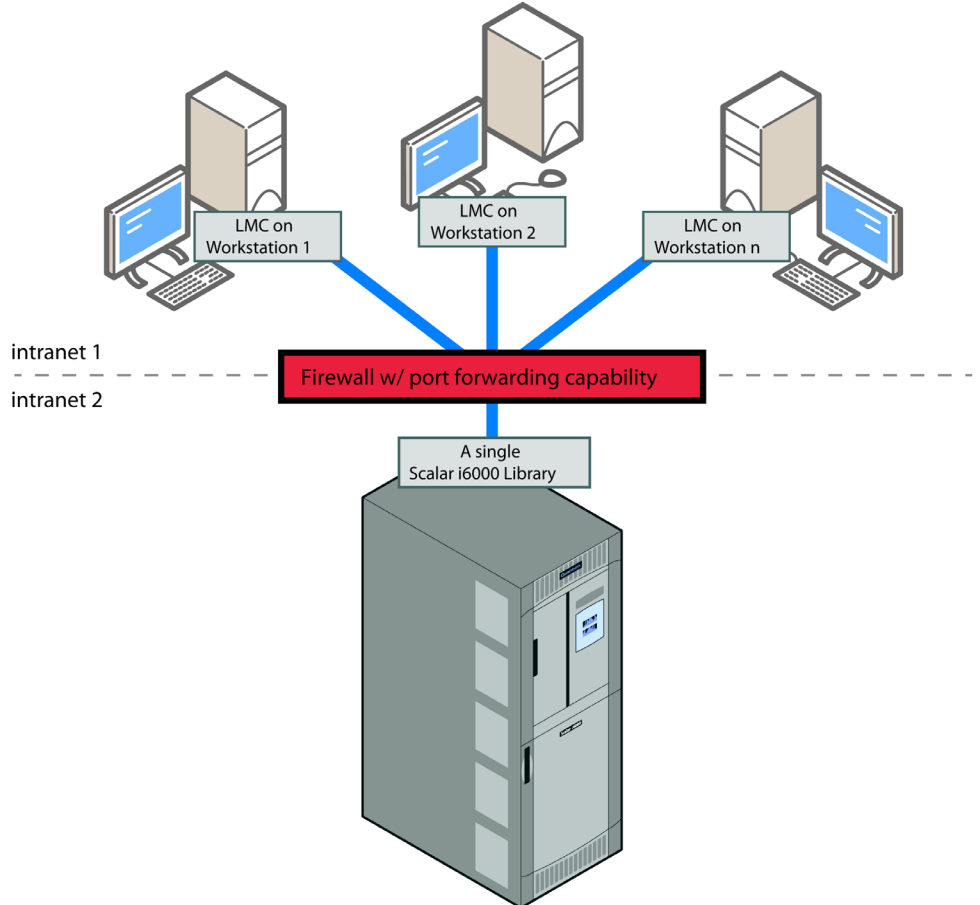

In the scenario shown in [Figure 25](#), customers can utilize port forwarding functionality to enable specific access to a Scalar i6000. Port forwarding works by taking all host communications directed to a specific port and forwarding them to a single IP device. In this case, port forwarding would be configured so that all communications to the Java RMI server port (1099) would be directed to the IP address of the Scalar i6000.

The benefit of this solution is that all traffic is forced to a single library and prevents any other traffic using port 1099 from going to other devices. This does mean that only a single Scalar i6000 can be accessed. Multiple Scalar i6000 libraries cannot be accessed.

Scenario 3: Internal clients accessing multiple libraries across an internal firewall

Many customers use a layered system of firewalls to safeguard resources. In the scenario shown in [Figure 26](#), a customer may have multiple Scalar i6000s which need to be administered by internal staff (for example, data center/network operations staff), with a firewall between the administrators and the libraries.

Figure 26 Multiple Libraries,
Internal Firewall

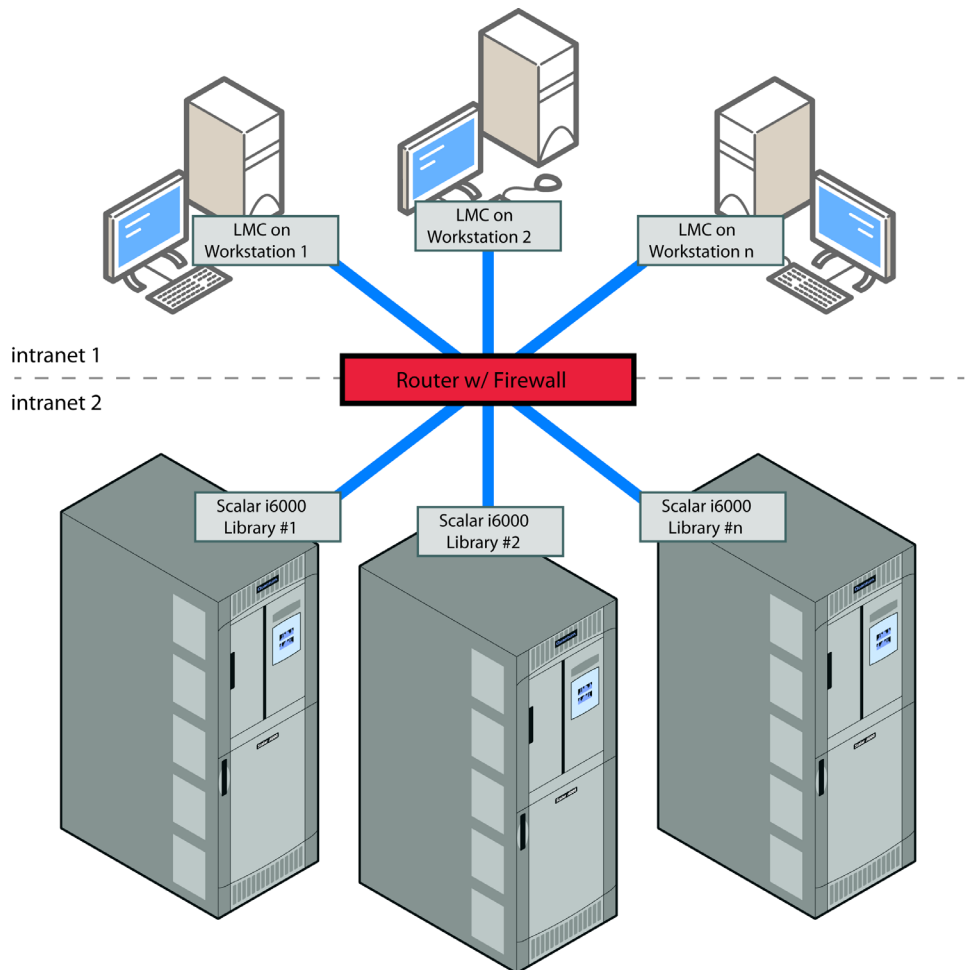

To enable LMC access between firewall zones, two solutions are possible depending on the customer configuration. If the two zones are on the same IP subnet, then the firewall will provide IP address and port blocking functionality and should follow these rules:

- Inbound access to port 1099 (Java RMI server port) by client IP addresses
- Stateful access control – used with most Web technologies (for example, Web mail) to enable a server to communicate with the client that started the connection

If the two zones are on different subnets, or an IP address translation is performed to mask the library's true IP address, then the firewall must provide routing rules that allow the client IP addresses to access specific library IP addresses.

Slot Capacity

Capacity on Demand

There are two types of slot capacities in Scalar i6000: physical capacity and licensed capacity. Physical capacity is added to a library by adding expansion modules to a configuration. Either DREMs, SEMs or HDEMs can be added, depending on the need.

Capacity on Demand allows you to license physical slots in 100-slot blocks. Any number of slots can be licensed between 100 and 12,000. You do not need to license all the physical slots, but only licensed slots can be assigned to host managed partitions. It is often desirable to have more physical slots installed than will be licensed.

Capacity on Demand allows you to purchase capacity for your library as needed. As your storage needs change, you can add storage in blocks of 100. Scalar i6000 licensing begins at 100 cartridges and can be increased to as many as 7,146 LTO cartridges (for a single-robot library) or 7,224 LTO cartridges (for a dual-robot library).

Expansion modules are sold separately from the slot licensing. This separation provides the flexibility to order the exact modules needed (DREM, SEM or HDEM).

Note: Maximum numbers assume only one drive and one 24-slot I/E station in the control module.

To gain the use of additional storage slots, you must purchase a Capacity on Demand license for the desired number of slots. Expansion modules may also be needed to add more physical capacity.

Unlicensed Slots

Active Vault and Extended Data Lifecycle Management (EDLM) features do not require the use of licensed slots. You may purchase additional expansion modules to accommodate these features without the need to increase your COD license. For more information, refer to the *Scalar i6000 User's Guide*.

Encryption and Key Management Solutions

The Scalar i6000 supports library managed encryption systems. These encryption systems use a centralized key manager application to generate, protect, store, and manage encryption keys. These keys are used by HP or IBM LTO-4, LTO-5, and LTO-6 tape drives to encrypt information being written to, and decrypt information being read from, tape media. Policy control and keys pass through the library-to-drive interface; therefore encryption is transparent to the host application software.

You must have an Encryption Key Management (EKM) license installed on the library to encrypting data using library managed encryption.

The Scalar i6000 supports the following encryption key management systems. For more information, see the *Scalar i6000 User's Guide*.

Note: The library does not support using more than one encryption key management server on a single library.

Table 2 Encryption Key Management/Drive Compatibility

Encryption System	Supported Tape Drives
Quantum Encryption Key Manager (Q-EKM) Note: Must purchase Q-EKM library licenses per tape drive used ¹ .	IBM LTO-4 Fibre Channel IBM LTO-5 Fibre Channel IBM LTO-6 Fibre Channel
Scalar Key Manager (SKM) Note: Must purchase SKM library licenses per tape drive used ¹ .	HP LTO-4 Fibre Channel HP LTO-5 Fibre Channel HP LTO-6 Fibre Channel IBM LTO-5 nFC (EEB required) IBM LTO-6 nFC (EEB required)
SafeNet key management (KMIP-compliant) (Not provided) Note: Must purchase 3rd party library licenses per tape drive used ¹ .	HP LTO-4 Fibre Channel HP LTO-5 Fibre Channel HP LTO-6 Fibre Channel IBM LTO-5 Fibre Channel IBM LTO-6 Fibre Channel
Thales Note: Must purchase 3rd party library licenses per tape drive used ¹ .	HP LTO-5 Fibre Channel HP LTO-6 Fibre Channel IBM LTO-5 Fibre Channel IBM LTO-6 Fibre Channel
IBM TKLM Note: Must purchase 3rd party library licenses per tape drive used ¹ .	IBM LTO-5 Fibre Channel IBM LTO-6 Fibre Channel

¹ Encryption license keys are activated for the number of drives installed in the library. These license keys are library licenses and do not transfer with the tape drives.



Chapter 3

System Specifications

This section provides performance, environmental, electrical, and physical specifications for modules in the library. The major sections include:

- [Performance Specifications](#) on page 58
- [Environmental Specifications](#) on page 59
- [Electrical Specifications](#) on page 60
- [Library Connection Types and Speeds](#) on page 65
- [Physical Specifications – Pallet](#) on page 66
- [Physical Specifications – Library](#) on page 66
- [Module Foot Pad Positions](#) on page 77
- [Module Floor Cutout](#) on page 78
- [LTO Drive Requirements and Compatibility](#) on page 80
- [Barcode Requirements](#) on page 82

Performance Specifications

Inventory time varies based on the number of modules and module type. The inventory times for each module are provided below:

- CM: 72 seconds
- DREM: 72 seconds
- SEM: 72 seconds
- HDEM (no scanner): 136 seconds
- HDEM (with scanner): 34 seconds
- LPM/RPM: 34 seconds
- Dual Robot feature generally reduces the inventory time by 50%.

Exchange performance is highly dependent on library configuration. Key performance factors include the number of modules, number of drives, placement of drives, use of HDEMs, and the number of partitions in the library. The library can be configured to meet specific robot performance. These configurations may require modules and other components that differ from standard configurations. Make sure any specific performance requirements are communicated prior to ordering the library and again prior to installation.

The Scalar i6000 is capable of performing up to 239 exchanges per hour with a single robot and single partition.

Environmental Specifications

[Table 3](#) lists the key environmental information for the library.

Table 3 Environmental Specifications

Temperature	Humidity	Altitude	BTU/Heat Dissipation	
			Minimum ^a	Maximum ^b
LTO:50°F - 95°F (10°C - 35°C) ^c	15 - 75%	10,000 ft	.375 kwh 1280 BTU/hour	8.862 kwh 30238 BTU/hour

a. Configuration includes a control module with one drive.

b. Configuration includes a left parking module, control module, 15 expansion modules and a right parking module with a total of 192 drives, 9 I/O management units and 33 I/O blades (3 blades in each of the 9 I/O management units).

c. Contingent on using LTO tapes that are qualified for use at 35°C.

Electrical Specifications

Each system can be configured with either a single or redundant power option. All modules within a system should follow the same power option strategy (either single or redundant). In dual robotics systems, the left parking module does not require a power source. The right parking module requires a power source if it contains drives.

The power cable length for each of these inputs is 14 feet (4.26 m). Depending on the type of module you receive, the following power cords will ship by default:

For HDEM and CM3, DREM3 and the applicable 2N option ship worldwide with two power cords (See [Table 4](#)):

- L6-20/C19 for North America, Part Number 1-03260-4
- IEC 60309/C19 for International, Part Number 1-03260-2

For CM2 and DREM2 Modules (See [Table 5](#)) one (1) of the following cables will be sent:

- L6-30 for North America, Part Number 9-02919-01
- IEC 60309 for International, Part Number 9-02925-01

Module Electrical Specifications

The typical power consumption for each module is listed in [Table 4](#) and [Table 5](#).

Note: Gen 1 robotics libraries, Gen 2 single-robotics libraries, and Gen 2 dual-robotics libraries have nearly identical readings and fall under these specifications.

Table 4 Electrical Specifications for HDEM and Series 3 Modules (CM3, DREM3 and SEM3)

Location	Voltage (Single Phase, 50 - 60 Hz)	Required Protective Service	Delivered Power Connector	Part Number	AMPs
North America	110	20	NEMA 5-20	9-02947-01	20
International	240	16	IEC 60309	1-03260-02	20 ^a or 16 ^b
North America	110	20	NEMA L5-20	9-02949-01	20
North America	208	20	NEMA L6-20	1-03260-04	20
International	240	16	CEE 7/7 EUROPEAN SHUKO	9-02951-01	16

a. 20 amps in North America
b. 16 amps international.

Table 5 Electrical Specifications for Series 2 Modules (CM2, DREM2)

Location	Voltage (Single Phase, 50 - 60 Hz)	Required Protective Service	Delivered Power Connector	Part Number	AMPs
North America	110	30	NEMA L5 - 30	9-01488-03	30
North America	208	30	NEMA L6 - 30	9-02919-01	30
North America	208	20	NEMA L6-20	9-02918-01	20
North America	208	15	NEMA L6 - 15	9-01488-04	15
International	240	16	IEC60309 2P+E	9-02292-01	20 ^a or 16 ^b

a. 20 amps in North America
b. 16 amps international.

Supported Power Connectors

The supported power connectors are shown in [Figure 27](#) and [Figure 28](#).

Figure 27 Supported Power Connectors - HDEM and Series 3 Modules (CM3, DREM3 and SEM3)

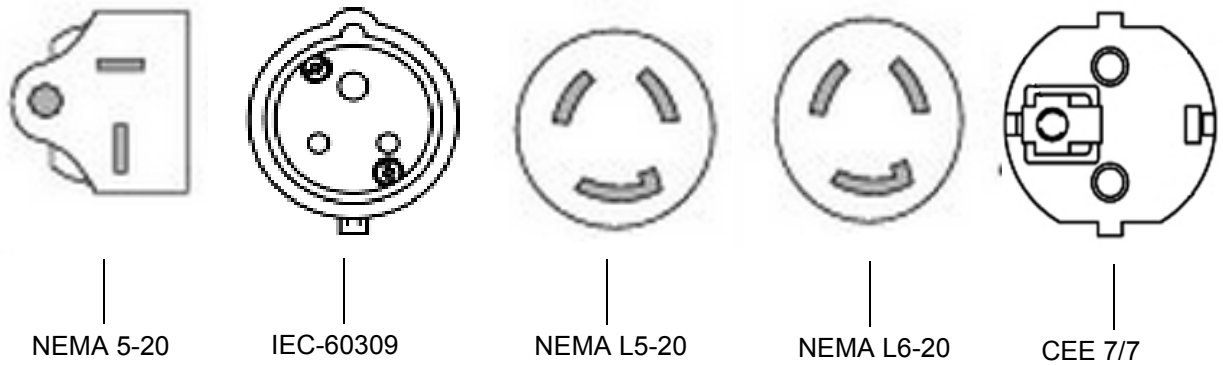
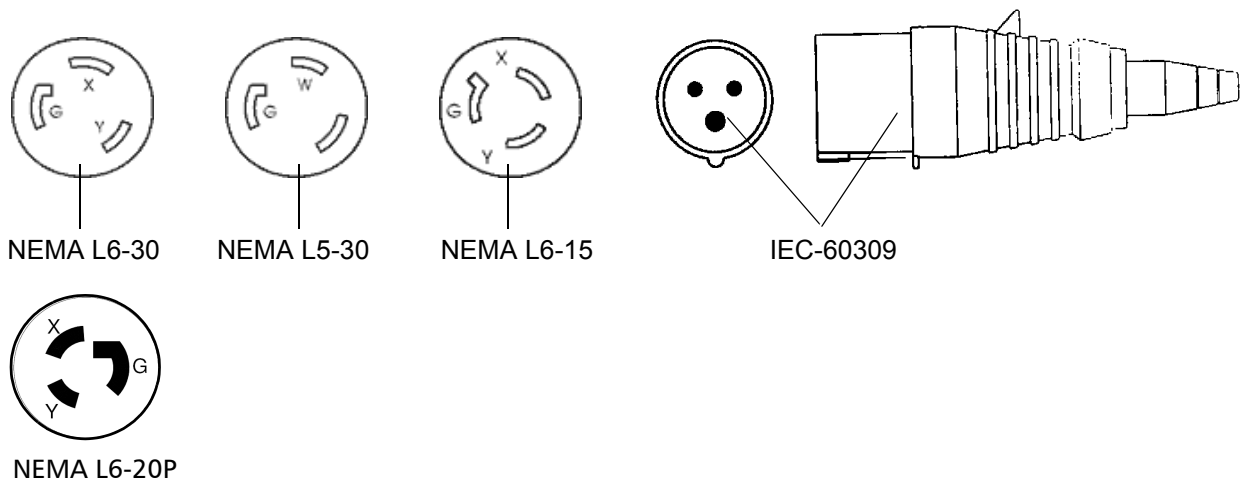

Figure 28 Supported Power Connectors - Series 2 Modules (CM2, DREM2)



Module Power Consumption

The power consumption for a control module is listed in [Table 6](#) and for storage only or drive expansion modules, see [Table 7](#).

Note: Gen 1 robotics libraries, Gen 2 single-robotics libraries, and Gen 2 dual-robotics libraries have nearly identical readings and fall under these specifications.

Table 6 Control Module Power Consumption

Subsystem	AMP @ 110 V	AMP @ 220 V	DC AMP @ 48 V	kW	BTU/hr
Base Module	1.82	0.91	4.2	0.200	682
Base Module - Extra Drives	1.45	0.73	N/A	0.16	546
1st Gen 2 Robot	0.3	0.15	0.73	0.035	119.4
2nd Gen 2 Robot	0.3	0.15	0.73	0.035	119.4
Gen 1 Robot	0.68	0.34	1.56	0.075	255.8
2nd PS2508 Power Supply	0.73	0.36	1.67	0.080	272.8
2nd PS2571 Power Supply ^a	0.75	0.37	N/A	0.080	272.8
IBM LTO-6 Drive (each)	0.3	0.15	0.71	0.034	115.9
IBM LTO-5 Drive (each)	0.4	0.2	1.0	0.048	153.5
IBM LTO-4 Drive (each)	0.35	0.18	0.8	0.038	129.6
HP LTO-6 Drive (each)	0.25	0.13	0.58	0.028	95.5
HP LTO-5 Drive (each)	0.25	0.13	0.58	0.028	95.5
HP LTO-4 Drive (each)	0.3	0.15	0.73	0.035	119.4
I/O Management Unit	0.5	0.25	1.5	0.052	177.3
FC I/O Blade (each)	1.0	0.5	2.0	0.110	375
Ethernet Expansion Blade (each)	0.1	0.05	0.2	0.010	34.1

a - used for Series 3 modules only

Notes:

- Drive values are writing uncompressed data (worst case)
- Max 18 drives in a Control Module
- Dual robot feature only available with Gen 2 Robot
- Dual robot values are for single MCB control, not redundant MCB
- Robot numbers are operating
- Base Module value does not include a robot or a drive

Table 7 SEM and DREM Power Consumption

Subsystem	AMP @ 110 V	AMP @ 220 V	DC AMP @ 48 V	kW	BTU/hr
Base Module	0	0	0	0	0
Base Module - Extra Drives	0	0	N/A	0	0
2nd PS2508 Power Supply	0.73	0.36	1.67	0.080	272.8
2nd PS2571 Power Supply ^a	0.75	0.37	N/A	0.080	272.8
IBM LTO-6 Drive (each)	0.3	0.15	0.71	0.034	115.9
IBM LTO-5 Drive (each)	0.4	0.2	1.0	0.045	153.5
IBM LTO-4 Drive (each)	0.35	0.18	0.8	0.038	129.6
HP LTO-6 Drive (each)	0.25	0.13	0.58	0.028	95.5
HP LTO-5 Drive (each)	0.25	0.13	0.58	0.028	95.5
HP LTO-4 Drive (each)	0.3	0.15	0.73	0.035	119.4
I/O Management Unit	0.5	0.25	1.5	0.052	177.3
FC I/O Blade (each)	1.0	0.5	2.0	0.110	375
Ethernet Expansion Blade (each)	0.1	0.05	0.2	0.010	34.1

a - used for Series 3 modules only

Table 8 HDEM Power Consumption

Subsystem	AMP @ 110 V	AMP @ 220 V	DC AMP @ 48 V	kW	BTU/hr
HDEM	0.635	0.32	N/A	0.07	238.7

Library Connection Types and Speeds

[Table 9](#) lists the library connection types and speeds.

Table 9 Library Connection Types and Speeds

Connection	Connector	Speed
Fibre Channel drive (control path bridging; IBM and HP LTO-5 and LTO-6 only)	LC	8 Gbps
Fibre Channel on FC I/O Blade (tape drives can be connected to the I/O blade but is not required to use the I/O blade for control path communications)	LC	4 Gbps (7404)
Ethernet on management control blade (MCB 2.0)	RJ45	1 Gb

Physical Specifications – Pallet

Pallet Specifications

The library control modules, expansion modules, and parking modules are each shipped on the same type of specially designed pallet. For dual-robot new installs or upgrades, the robots will be shipped inside the module.

The pallet's dimensions are listed in [Table 10](#).

Table 10 Pallet Dimensions –
Module Only

Height	Width	Length
87 in. 221.0 cm	42.5 in. 108.0 cm	48 in. 121.9 cm

Physical Specifications – Library

This section contains the physical specifications for all possible library configurations.

The maximum weight, distributed load, and point load figures provided in the sections below were calculated using the heaviest configurations for a given frame count. Where differences between Gen 1/Gen 2 or single robotics/dual robotics exist, the heaviest number was used.

Note: If the library is installed on a raised floor, the raised floor should be stabilized to prevent any horizontal movement. The library has four point loads each on the control and expansion modules.

This section covers:

- [Configuration Rules](#) on page 67

- [Basic Building Blocks](#) on page 69
- [Examples of Common Configurations](#) on page 72

Configuration Rules

The Scalar i6000 is a highly configurable library. Standard configuration rules are used for the placement of drives and modules. If specific configuration requirements are needed, e.g. placing drives in specific modules, then these requirements must be communicated before the library/upgrade order is placed so all the components needed to support the configuration are ordered and shipped. The standard configuration rules are listed below (orientation is based on facing the front of the library):

Minimum number of modules

- The minimum configuration for Gen 1 or Gen 2 library with a single robot is one module: the Control Module.
- The minimum configuration for Gen 2 library with Dual Robots is three modules: the Left Parking Module, Control Module and Right Parking Module.
- The minimum configuration for a Gen 2 library with dual robots and an HDEM is four modules: the left parking module, control module, HDEM and right parking module.

Maximum number of modules

- A Gen 1 single-robot library can support up to 12 modules (CM + 11 DREMs/SEMs).
- A Gen 2 single-robot library can support up to 16 modules (CM + 15 DREMs/SEMs/HDEMs, HDEMs require gen2 electronics).
- A Gen 2 dual-robot library can support up to 17 modules (LPM + CM + 14 DREMs/SEMs/HDEMs + RPM; HDEMs require gen2 electronics).

Placement of Modules

- Control Module (CM) location is always the first module on the left, except when Dual Robots are installed. When Dual Robots are installed, the CM is the second module from the left.
- Expansion Modules:
 - Drive Ready Expansion Module (DREM) are always installed to the right of the CM. If there are multiple DREMs to be installed, the order of the DREMS is a 72 slot I/E station is first, then a 24 slot I/E station and finally a DREM without an I/E station.
 - High-Density Expansion Modules (HDEM) are placed after the CM and DREMs. If there are multiple HDEMs to be installed, the order of the HDEMS is a 72 slot I/E station is first, then a 24 slot I/E station and finally a HDEM without an I/E station.
 - Storage Expansion Module (SEM) are placed after the CM, DREMs and HDEMs. If there are multiple SEMs to be installed, the order of the SEMS is a 72 slot I/E station is first, then a 24 slot I/E station and finally a SEM without an I/E station.
 - Modules that are added to existing systems are added to the right. One exception is if an HDEM or DREM3 is added to a Dual Robot library, in this case the HDEM or DREM3 is inserted to the left of the Right Parking Module.
- Parking Module:
 - Left Parking Module (LPM) is only used when Dual Robots are installed and is always located on the far left of the library. Note, the LPM is not ordered separately, it is shipped with the Dual Robot.
 - Right Parking Module (RPM) is only used when Dual Robots are installed and is always located on the far right of the library. The RPM is a converted SEM or DREM.
 - An HDEM or DREM3 cannot function as a parking module.

Import/Export (I/E) Station Support and Placement

- The Control Module always ships with a 24 slot I/E station and there are no other options.
- Optional 24-slot I/E Station can be installed in any DREM, SEM, HDEM or RPM.

- Optional 72-slot can be installed in DREMs, HDEMs or SEMs, but not in the RPM.
- The LPM cannot support I/E Stations.
- A maximum of 16 I/E stations (including the CM I/E Station) can be installed in a library, but with the restrictions listed above.
- I/E Stations are installed left to right, with the 72-slot I/E Stations installed closest to the CM followed by 24-slot I/E Stations.

Tape Drive Support and Placement

- The library supports a maximum of 192 tape drives.
- Tape drives are only installed in CMs and DREMs.
- SEMs, HDEMs and the LPM do not support tape drives, but SEMs can be converted to DREMs for drive support. Note that DREMs can only be used as a RPM in a Dual Robot library if they do not have the full compliment of 24 drives.
- A maximum of 18 drives can be installed in each control module and a DREM can contain a maximum of 24 drives.
- While drives can be installed in any module configured to accept them, it is recommended that they are installed left to right, with the first drives installed in the CM and moving to the next DREM to the right.

Power cords

- The default power cords are sent with each CM, DREM and HDEM. If redundant power is ordered, an extra cord is sent. If any of the optional power cords are needed, they must be ordered.

Basic Building Blocks

[Table 11](#) provides specifications for the common building blocks to help you calculate your specific configuration.

Table 11 Basic Building Blocks

Components	Weight	Point Load	Height	Width	Depth
Details specific to single-robot configuration					
CM – fully loaded: robot, drives, redundant power, 24-slot I/E, media	899 lb 409 kg	71.5 lb/in. ² 5.0 kg/cm ²	77.4 in 196.6 cm	24.3 in 61.7 cm	38.3 in 97.3 cm
Details Specific to Dual-Robot Configuration					
CM – Fully loaded: no robot, drives, redundant power, 24-slot I/E, media	897 lb 408 kg	71.4 lb/in. ² 5.0 kg/cm ²	77.4 in 196.6 cm	24.3 in 61.7 cm	38.3 in 97.3 cm
LPM – Fully loaded: robot, media	623 lb 283 kg	49.6 lb/in. ² 3.5 kg/cm ²	77.4 in 196.6 cm	23.6 in 59.9 cm	38.3 in 97.3 cm
RPM – Fully loaded: drives, redundant power	820 lb 373 kg	65.2 lb/in. ² 4.6 kg/cm ²	77.4 in 196.6 cm	23.6 in 59.9 cm	38.3 in 97.3 cm
RPM – Fully loaded: drives, redundant power, 24-slot I/E, media	820 lb 373 kg	65.2 lb/in. ² 4.6 kg/cm ²	77.4 in 196.6 cm	23.6 in 59.9 cm	38.3 in 97.3 cm
RPM – Media only	723 lb 329 kg	57.5 lb/in. ² 4.1 kg/cm ²	77.4 in 196.6 cm	23.6 in 59.9 cm	38.3 in 97.3 cm
HDEM - Fully loaded with LTO media	985 lb 448 kg	78.3 lb/in. ² 5.5 kg/cm ²	77.4 in 196.6 cm	24.3 in 61.7 cm	38.3 in 97.3 cm
Details common to both configurations					
SEM/DREM – Empty	586 lb 266 kg	46.6 lb/in. ² 3.3 kg/cm ²	77.4 in 196.6 cm	23.6 in 59.9 cm	38.3 in 97.3 cm
SEM/DREM – Media only	820 lb 373 kg	65.2 lb/in. ² 4.5 kg/cm ²	77.4 in 196.6 cm	23.6 in 59.9 cm	38.3 in 97.3 cm
DREM – Fully loaded: drives, redundant power, media	882 lb 401 kg	70.2 lb/in. ² 4.9 kg/cm ²	77.4 in 196.6 cm	23.6 in 59.9 cm	38.3 in 97.3 cm

Components	Weight	Point Load	Height	Width	Depth
DREM – Fully loaded: drives, redundant power, 24-slot I/E, media	882 lb 401 kg	70.2 lb/in ² 4.9 kg/cm ²	77.4 in 196.6 cm	23.6 in 59.9 cm	38.3 in 97.3 cm
DREM – Fully loaded: drives, redundant power, 72-slot I/E, media	894 lb 406 kg	71.1 lb/in ² 5.0 kg/cm ²	77.4 in 196.6 cm	23.6 in 59.9 cm	38.3 in 97.3 cm
HDEM - Empty	627 lb 284 kg	49.6 lb/in ² 3.5 kg/cm ²	77.4 in 196.6 cm	24.3 in 61.7 cm	38.3 in 97.3 cm
HDEM - Fully loaded with LTO Media	994 lb 451 kg	78.3 lb/in ² 5.5 kg/cm ²	77.4 in 196.6 cm	24.3 in 61.7 cm	38.3 in 97.3 cm
HDEM - Fully loaded: redundant power, media, 24-slot I/E	977 lb 443 kg	80.3 lb/in ² 5.6 kg/cm ²	77.4 in 196.6 cm	24.3 in 61.7 cm	38.3 in 97.3 cm
HDEM - Fully loaded: redundant power, media, 72-slot I/E	949 lb 430 kg	78 lb/in ² 5.5 kg/cm ²	77.4 in 196.6 cm	24.3 in 61.7 cm	38.3 in 97.3 cm

Examples of Common Configurations

The smallest library configuration consists of the control module only. The minimal configuration contains one I/E station and one drive.

Note: This configuration applies to single-robot systems only.

The maximum Gen 1 library configuration is 12 frames and the maximum Gen 2 library configuration is 17 frames. The maximum Gen 1 and Gen 2 single-robotics configurations are shown in [Figure 29](#) and [Figure 30](#).

The smallest dual-robotics library configuration is a three-frame system. It consists of one control module, a left parking module, and a right parking module. The minimum with an HDEM is a four-frame system since an HDEM cannot be a parking module.

Note: This configuration is only available for a dual-robot setup.

The maximum library configuration is 17 frames. A dual-robotics seventeen frame configuration consists of the control module, left parking module, right parking module, and fourteen expansion modules. The maximum dual-robotics configurations are shown in [Figure 31](#) and [Figure 32](#).

Note: 24.3" is Quantum's minimum physical clearance requirement. Consult local building code enforcement agency to determine your building's minimum working space.

Figure 29 Gen 1 single-robot configuration

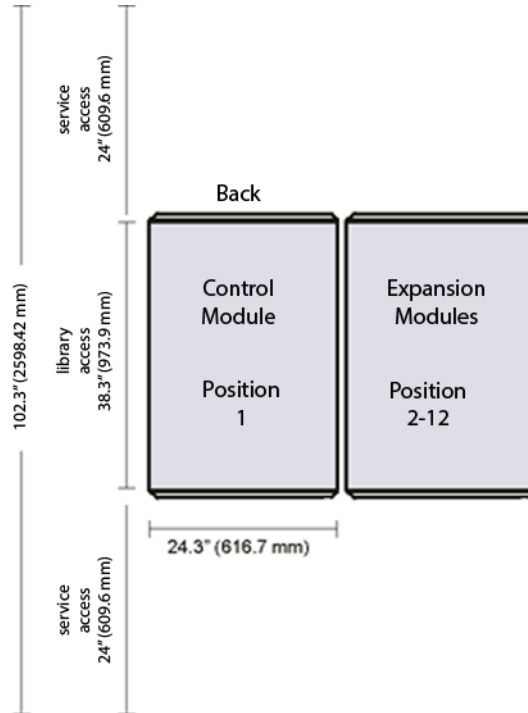

Figure 30 Gen 2 single-robot configuration

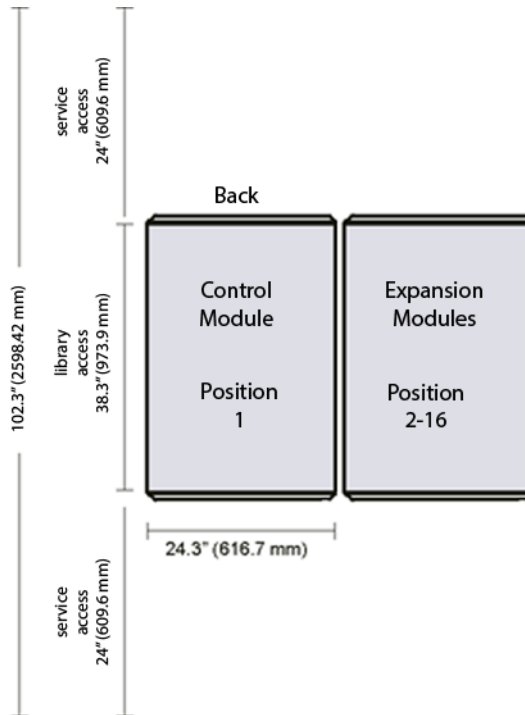

Figure 31 Dual-robot configuration

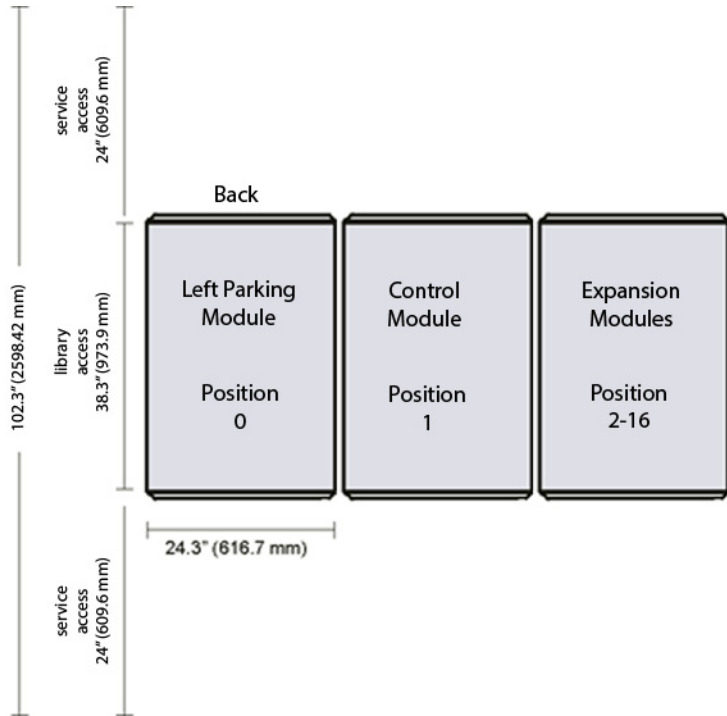
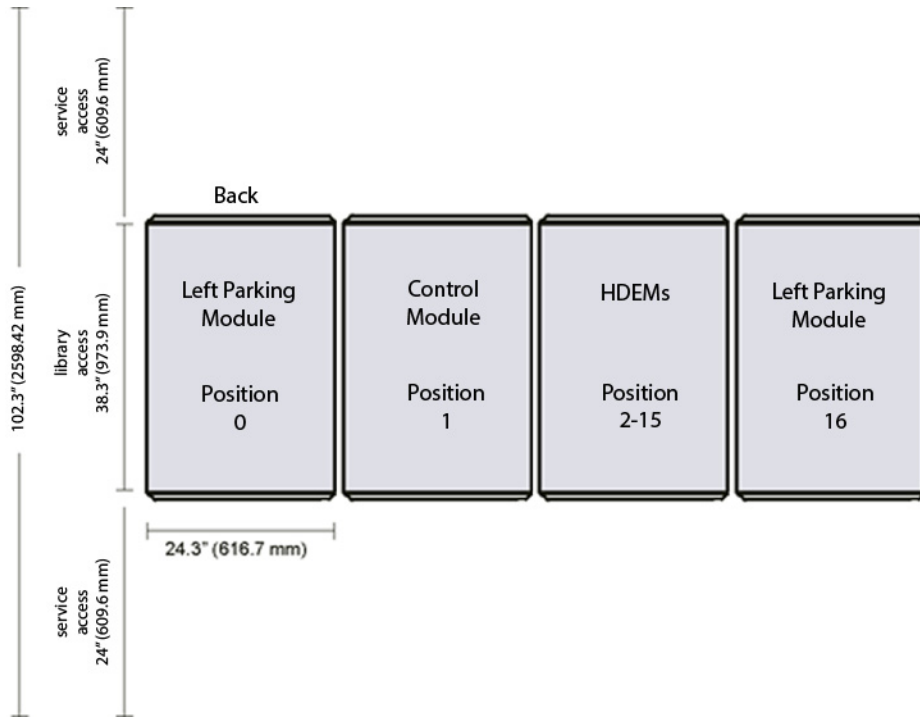

Figure 32 Dual-robot, HDEM configuration



Module Foot Pad Positions

The library foot pad positions looking down from the top are shown in [Figure 33](#). The foot pad positions are the same for the control module, expansion modules, HDEMs and parking modules.

Figure 33 Library Module Foot Pad Positions

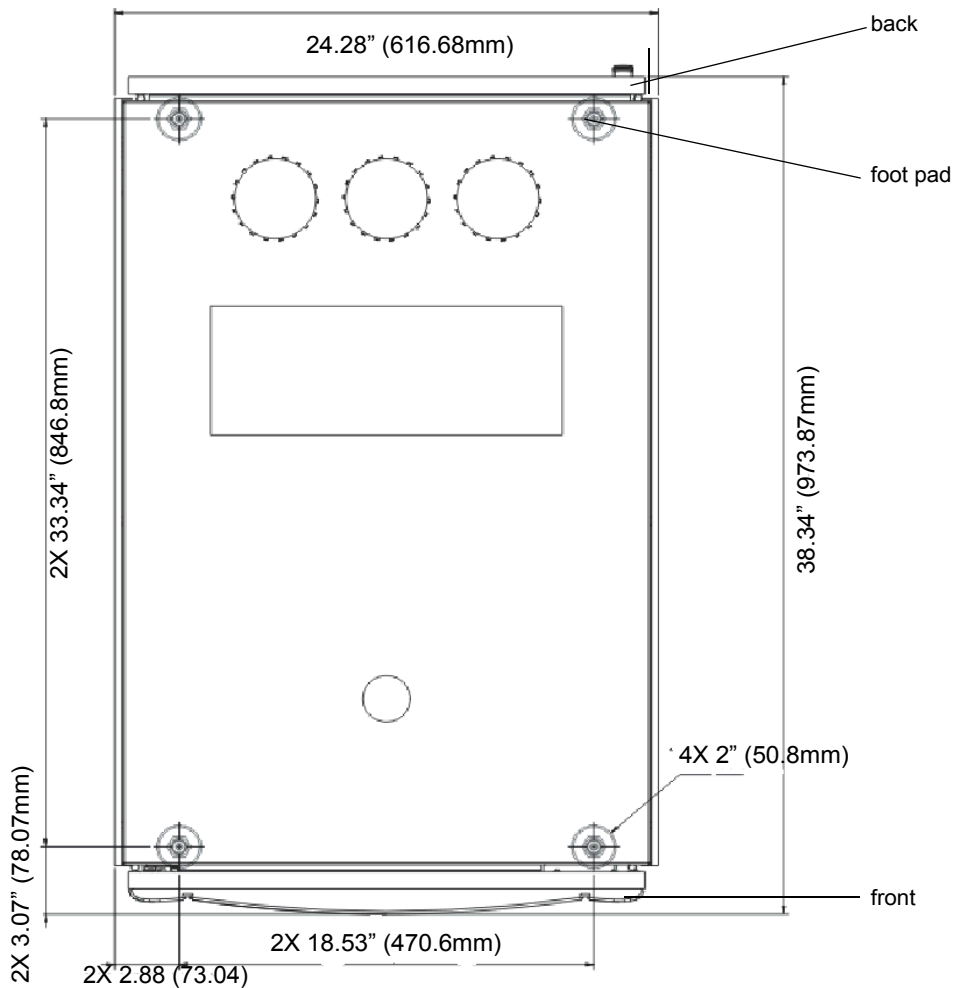

Module Floor Cutout

The foot pad positions are shown from underneath the library in [Figure 34](#). The module floor cutouts are the same for the control module, expansion modules, and parking modules. However, the HDEM has a different module floor cutout, as seen in [Figure 36](#) and [Figure 37](#).

Note: Floor cutouts can be used for cable access as well as the access hole at the top of the module.

Figure 34 Module Floor Cutout (Bottom View)

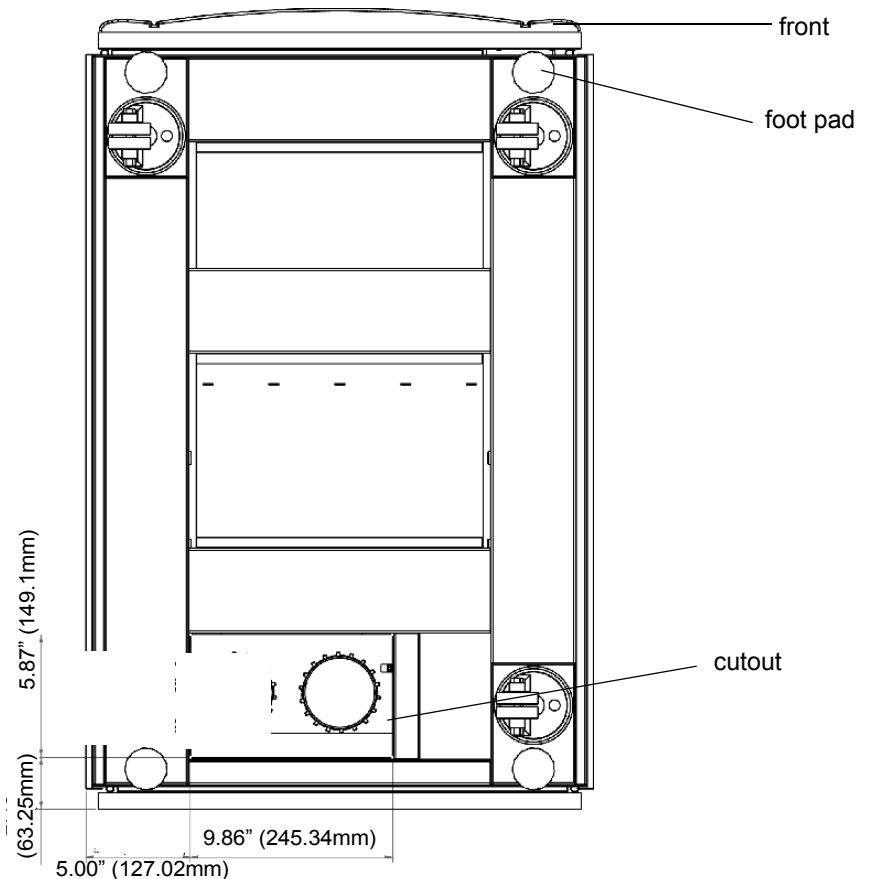

Figure 35 Module Floor
Cutout (Front View)

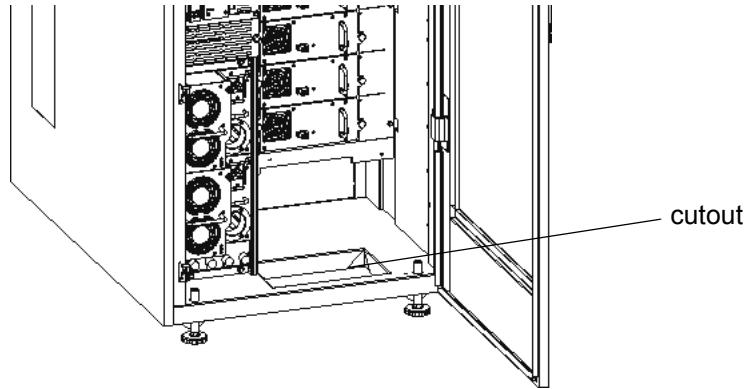

Figure 36 HDEM Floor Cutout
(Bottom View)

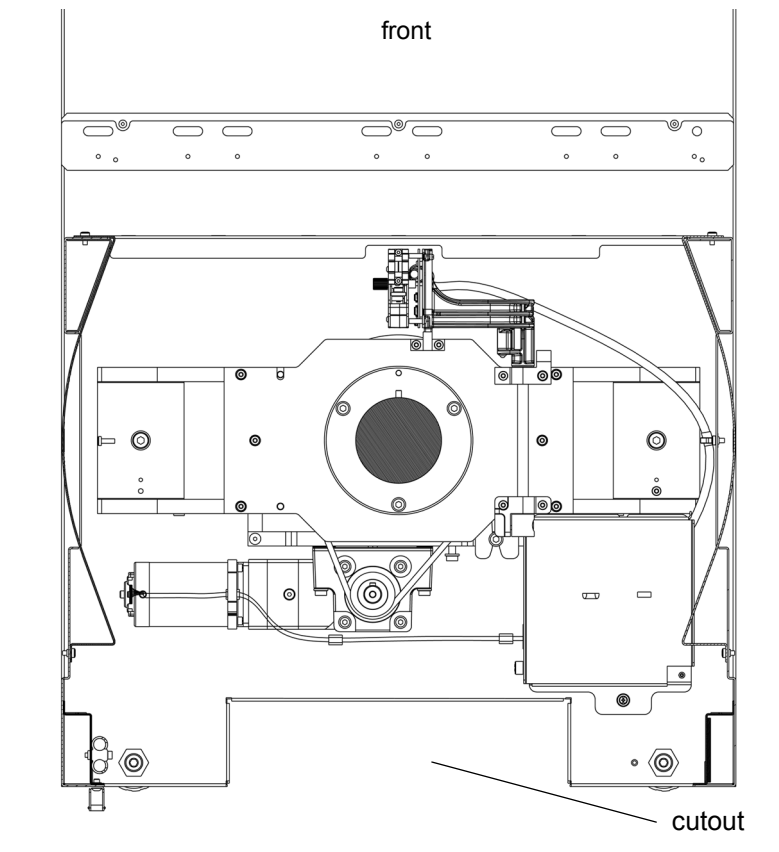
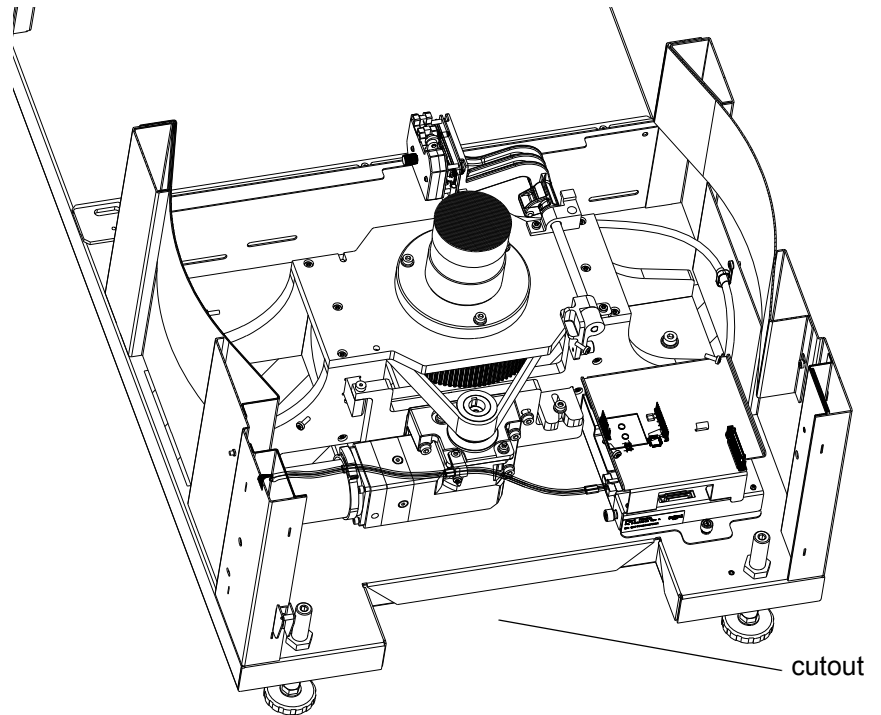

Figure 37 HDEM Floor Cutout
(Front View)



LTO Drive Requirements and Compatibility

The control module and any drive ready expansion module (including the right parking module in dual-robot configurations) can each contain up to 12 FC linear tape-open format tape drives (LTO-1, LTO-2, LTO-3, LTO-4, LTO-5, and LTO-6).

Although all six generations of LTO drives are supported in the library, the drives are not fully compatible (both read/write) as shown in [Table 12](#).

Table 12 LTO Drive
Compatibility

	LTO-1	LTO-2	LTO-3	LTO-3 WORM	LTO-4	LTO-4 WORM	LTO-5	LTO-5 WORM	LTO-6	LTO-6 WORM
LTO-1 Drive	Reads/ Writes	N/C	N/C	N/C	N/C	N/C	N/C	N/C	N/C	N/C
LTO-2 Drive	Reads/ Writes ^a	Reads/ Writes	N/C	N/C	N/C	N/C	N/C	N/C	N/C	N/C
LTO-3 Drive	Reads ^b	Reads/ Writes ^c	Reads/ Writes	Write Once, Read Many ^d	N/C	N/C	N/C	N/C	N/C	N/C
LTO-4 Drive	N/C	Reads	Reads/ Writes	Write Once/ Read Many	Reads/ Writes	Write Once, Read Many ^e	N/C	N/C	N/C	N/C
LTO-5 Drive	N/C	N/C	Read	Read Many	Reads/ Writes	Write Once, Read Many	Reads/ Writes	Write Once/ Read Many ^f	N/C	N/C
LTO-6 Drive	N/C	N/C	N/C	N/C	Read	Read Many	Reads/ Writes	Write Once, Read Many	Reads/ Writes	Write Once, Read Many

a.)LTO-2 drives do not reformat LTO-1 cartridges. The drives will write to the cartridges in the LTO-1 format (100 GB capacity).

b.LTO-3 drives only read LTO-1, they do not write to the LTO-1.

c.LTO-3 drives do not reformat LTO-2 cartridges to contain the same density as the LTO-3 cartridges (400 GB). The LTO-3 drives will write to the LTO-2 cartridges in the LTO-2 format (200 GB capacity).

d.LTO-3 WORM requires the installation of library firmware and WORM-supported LTO-3 tape drive code

e. LTO-4 WORM requires the installation of the library firmware and WORM-supported LTO-4 tape drive code.

f.LTO-5 WORM requires the installation of the library firmware and WORM-supported LTO-5 tape drive code.

All LTO cartridges are the same size, which means they use the same magazines in the library. LTO drives can be directly attached to hosts, attached to the storage area network (SAN), or connected to FC I/O blades in the I/O management unit.

Barcode Requirements

Cartridges must have an external barcode label that is machine-readable to identify the volume serial number. A barcode must use only uppercase letters A to Z and/or numeric values 0 to 9. The library supports Code 39 (3 of 9) type barcode labels.

For LTO media barcodes, the library dynamically supports 1 to 14 characters for volume serial number plus a two-character media type identifier. The image below is an example of a supported LTO barcode label.

Note: A 14-character barcode label length may not be printable according to the Code 39 label specifications for the tape cartridge area to which the label is attached. The effective tape cartridge barcode label length, including any media ID, may be limited to a maximum of 12 characters.



Quantum-supplied barcode labels will provide the best results. Barcode labels from other sources can be used, but they must meet the following requirements:

- ANSI MH10.8M-1983 Standard
- Number of characters: 6+2 (LTO)
- Background reflection: greater than 25 percent
- Print contrast: greater than 75 percent
- Ratio: greater than 2.2
- Module: $\geq .254$ mm
- Print tolerance: ± 57 mm

Additional Requirements:

- Height of the visible portion of the barcode: 10 mm \pm 2 mm
- Length of the rest zones: 5.25 mm \pm 0.25 mm

- No black marks should be present in the intermediate spaces or rest zones
- No white areas should be present on the bars

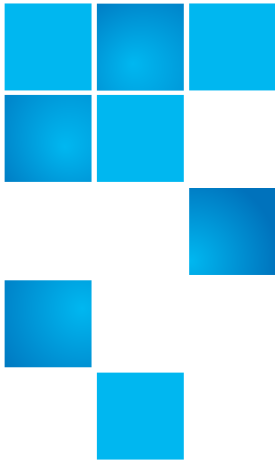

Chapter 4

Site Preparations

This chapter provides a structure for the collection of all necessary information concerning the delivery site. Record all requested information in the forms provided or create additional sheets as needed. This chapter provides the following information:

- [General Information](#) on page 86
- [Physical Environment](#) on page 88
- [Access Conditions](#) on page 90
- [Required Configuration Information](#) on page 94
- [SAN Readiness](#) on page 96
 - [NPIV Requirements](#) on page 97
- [Dual Robotics Upgrade Requirements](#) on page 97
- [Gen 2 Single Robotics Upgrade Requirements](#) on page 98
- [High-density Expansion Module Requirements](#) on page 99
- [Additional Comments](#) on page 99

General Information

Place any additional information in [Additional Comments](#) on page 99.

Customer name

Mailing address

Shipping address

Sales contact

Telephone

Quantum sales rep.

Quantum account
manager

Installation contact

Telephone

Target installation date

Target operational date

Physical Environment

Place any additional information in [Additional Comments](#) on page 99.

Room dimension

Ceiling projection

Floor type

Floor load capacity

Fire protection

Seismic bracing - If seismic bracing is being used, verify that the seismic bracing solution is supported prior to installation.

Type of power connector required

Access Conditions

Access to the library room (elevator, stairs, door widths, etc.)

Dimensions and location of the smallest door or opening

Loading dock specifications (dock height, type of ramps, weather protection, etc.)

Semitrailer accessibility (Y or N)

Preferred/required local carrier company

Where is the trailer location for staging?

Availability of material handling equipment

Location for uncrating

Preferred time of day for unloading and moving materials

Off hours/weekends accessibility for installation team

Procedure for obtaining building passes

Procedure for scheduling the elevator, loading dock

Waste disposal considerations

Bargaining unit considerations

Other considerations

Required Configuration Information

The following is some of the information that will be needed during installation of the library. Place any additional information in [Additional Comments](#) on page 99.

Library name:

License string:

IP address (internal)

IP addresses of the two
network time protocol (NTP)
servers:

1.

2.

SNMP server:

SNMP account:

SNMP sender address

Subnet mask:

Default gateway:

SMTP server IP address:

If your mail server requires a user name and password you can enable this on the library and enter these for e-mail authentication.

E-mail addresses of local administrators to be notified if issues arise with the library:

Operating system and version running off the remote servers that will connect to the library:

SAN Readiness

All servers or appliances intended to communicate with the Scalar i6000 robotic controller or tape drives must be already installed on the SAN before configuring the library for fiber channel SAN connectivity. Additionally, the World Wide Names (WWNs) of the associated fiber channel HBAs should be visible on the SAN. This is necessary because the Scalar i6000 "Extended Virtual Private SAN" (eVPS) feature can only grant LUN access to WWNs it discovers on the SAN at the time of configuration.

Are all necessary servers or appliances visible on the SAN? (Y or N):

NPIV Requirements

To configure a tape drive for either control path or data path failover, you need the following:

- The library must have a Native Storage Networking license installed.
- The tape drive to be configured for data path failover must be licensed for native storage networking.
- The tape drive must be an HP LTO-5 or LTO-6 Fibre Channel tape drive.
- The tape drive must be connected to an Ethernet Expansion Blade (EEB) via an Ethernet cable. The minimum number of EEBs are included with the Native Storage Networking license. Additional EEBs may be purchased if desired.
- Both tape drive fibre ports **MUST** be connected to switches that are part of the same fabric. For example, Fabric A to Fabric B failover is **NOT** supported.
- Switch fabric zoning strategy **MUST** use the WWPN strategy.
- Both FC ports on the tape drive must be connected to an NPIV-supported switch, and both switch ports **MUST** have N-Port Virtualization (NPIV) enabled. Neither tape drive port may be connected to a host or Fibre Channel I/O blade.
- Quantum recommends making sure your switches are at the latest firmware version to ensure stable N-Port Virtualization (NPIV) functioning.
- The tape drive topology settings must be set to Point to Point.
- HP LTO-5 and LTO-6 FC tape drive firmware must be at the version qualified with the Scalar i6000 library (see the *Scalar i6000 Release Notes* for qualified firmware levels).

Dual Robotics Upgrade Requirements

If you are upgrading your library from a single robot system to a dual robot system (whether from Gen 1 or Gen 2), please understand and address the following requirements before Service arrives to do the upgrade:

<input checked="" type="checkbox"/>	Requirement
<input type="checkbox"/>	Scalar i6000 — Scalar i2000 libraries must be upgraded to Scalar i6000 before upgrading to dual robotics.
<input type="checkbox"/>	Gen 2 — Dual robotics libraries use the Gen 2 robot. If you are upgrading from a Gen 1 system, the hardware and robots need to be upgraded to Gen 2. You cannot add a second robot to a Gen 1 system.
<input type="checkbox"/>	No DLT tape drives, media, or magazines — Dual robotics libraries do not support DLT tape drives or media. Remove these from the library before the upgrade.
<input type="checkbox"/>	Sufficient physical space — The dual robotics library upgrade requires a left parking module to be installed to the left of the control module. Make sure you have sufficient space for the additional module. If this will require moving the library, ensure the new space is prepared, ready, and level prior to the upgrade. Note: The minimum dual-robot configuration consists of three modules (left parking module, control module, and right parking module).
<input type="checkbox"/>	No 72-slot I/E station in right-most module — The right-most module of a dual-robotics system cannot have a 72-slot I/E station. If your current right-most expansion module contains a 72-slot I/E station, notify your Sales representative so that an additional module can shipped and installed on the right end of the system. (If you do not have space for an additional module, then Service will swap your right-most module with an existing module in the library that does not contain a 72-slot I/E station.)

Gen 2 Single Robotics Upgrade Requirements

If you are upgrading a Gen 1 library to a Gen 2 single-robotics library, please understand and address the following requirements before Service arrives to do the upgrade:

<input checked="" type="checkbox"/>	Requirement
<input type="checkbox"/>	Scalar i6000 — Scalar i2000 libraries must be upgraded to Scalar i6000 before upgrading to Gen 2 robotics.
<input type="checkbox"/>	No DLT tape drives, media, or magazines — Gen 2 robotics libraries do not support DLT tape drives or media. Remove these from the library before the upgrade.

High-density Expansion Module Requirements

Add.

<input checked="" type="checkbox"/>	Requirement
<input type="checkbox"/>	Scalar i6000 — Scalar i6000 libraries must be upgraded to i11 before an HDEM can be added.
<input type="checkbox"/>	The Scalar i6000 library must contain a Gen 2 Robotics and Electronics Kit to support an HDEM.

Additional Comments

Record any additional information from other pages. For reference purposes, note the page number with the information. Add and number additional sheets as necessary.

