

Quantum.

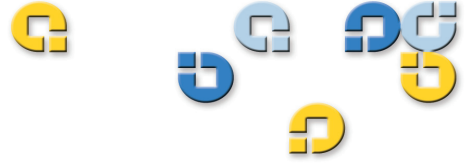

User's Guide User's Guide User's Guide User's Guide User's Guide

Quantum Scalar 50

Scalar Series

81-81768-02 A01

Quantum Scalar 50 User's Guide, 81-81768-02 A01, July 2008, Made in USA.

Quantum Corporation provides this publication "as is" without warranty of any kind, either express or implied, including but not limited to the implied warranties of merchantability or fitness for a particular purpose. Quantum Corporation may revise this publication from time to time without notice.

COPYRIGHT STATEMENT

Copyright 2008 by Quantum Corporation. All rights reserved.

Your right to copy this manual is limited by copyright law. Making copies or adaptations without prior written authorization of Quantum Corporation is prohibited by law and constitutes a punishable violation of the law.

TRADEMARK STATEMENT

DLT, SDLT, DLTtape III, DLTtape IV and Super DLTtape I are all trademarks of Quantum Corporation. Other trademarks may be mentioned herein which belong to other companies.

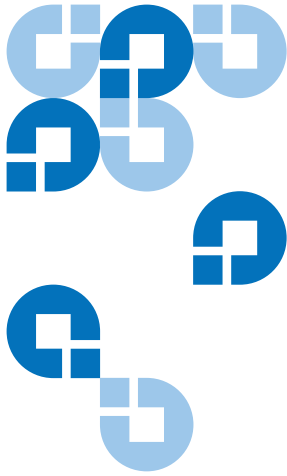

Contents

Preface

	xvii
StorageCare Guardian.....	xxii

Chapter 1

Library Description	1
Overview.....	2
Tape Drives.....	5
Tape Drive Types.....	5
Library Features.....	8
Front Panel.....	8
Internal Layout.....	10
Back Panel.....	11
DLTSage™ Tape Security.....	13
Mixed Media Support.....	13
Capacity on Demand.....	13
Enabling Capacity on Demand.....	14
Library Scalability (Stacked Configurations).....	15
Multiple Library Stack Requirements.....	15
Getting Started.....	18
Installing the Quantum Scalar 50.....	18
Cabling the Quantum Scalar 50 Series.....	19
Loading Tape Cartridges.....	20
Initial Configuration.....	20

Chapter 2	Basic Library Operations	21
	Installing Tape Cartridges	21
	Taking ESD Precautions	23
	SDLT Cartridges	24
	LTO Cartridges	26
	Cleaning Cartridges.....	28
	Preparing the Library for Operation.....	30
	Close the Cabinet Doors and Access Panels	30
	Connecting to Host Workstations	31
	Turning the Library On and Off	36
	Turning On the Library.....	36
	Turning Off the Library	37
	Placing the Library On-line or Off-line.....	37
	Using the OCP	37
	Home Screen.....	37
	OCP Buttons	38
	OCP Components	38
	Info Screen	40
	Operations Screen.....	45
	Setup Screen.....	50
	Diags Screen	57
	Load Port Configuration.....	60

Chapter 3	Quantum Scalar 50 Remote Management	63
	Quantum Scalar 50 Web Pages	64
	Quantum Scalar Web Page Menu Items.....	64
	Accessing Scalar 50 Web Pages.....	67
	Using the Quantum Scalar 50 Web Pages	67
	Quick Status.....	68
	Status.....	70
	Overview Page	70
	Hardware Status Page.....	71
	Event Log Page.....	72
	Statistics Page	73
	Operations.....	77
	Accessing the Operations Page.....	77
	Find Page.....	78
	Move Page.....	80
	Inventory Page	82
	Drives Page.....	83

Setup	84
Accessing the Setup Page	85
Identification.....	86
Users	87
Key Users	88
SCSI/Fibre	91
iSCSI Bridge.....	92
Network	93
Events	95
Date & Time.....	99
Library	101
Partitions	102
Field Service.....	108
Setup Wizard.....	108
Secure Key.....	113
Protection Mode for Cartridges	115
Enable/Disable Secure Key for Drives	116
Select Secure Key for Library	117
Assign Secure Key to Cartridge.....	117
Create Secure Key Name/Secure Key Pair	118
Delete Secure Key Name	119
Backup Secure Key File.....	120
Upload Secure Key File.....	121
Secure Key Best Practices and Tape Migration	122
Best Practices	122
Key Migration Scenarios.....	122
Utilities	124
Library	125
System Tests	127
Maintenance	129
Logs.....	131
Tasks	133
Reference	134
Logout.....	136

Chapter 4	SNMP Trap List	137
------------------	-----------------------	------------

Chapter 5	Troubleshooting	164
	Common Problems and Solutions	164

Start-up Problems	165
OCP Problems	166
Robotics (Hand) Problems.....	166
Operating Problems	168
Interpreting System LED Status	170
Operator Control Panel (OCP) LED Status.....	171
System Controller Board (SCB) LED Status.....	171
Power Supply LED Status	175
Tape Drive LED Status.....	176

Appendix A	Specifications	177
-------------------	-----------------------	------------

Physical Specifications	178
Performance Specifications.....	179
Reliability Specifications	180
Tape Drive Specifications	180
Environmental Specifications.....	181
Noise Levels.....	181
SCSI Specifications.....	181

Appendix B	SDLTtape Cartridge Maintenance	182
-------------------	---------------------------------------	------------

Handling DLTtape Cartridges	182
Visual Inspection of DLTtape Cartridges.....	183
When To Visually Inspect a DLTtape Cartridge.....	183
Visual Inspection Procedure	183

Appendix C	Installing the Scalar 50 Library	187
-------------------	---	------------

Selecting an Installation Location.....	187
Rack Space Requirements.....	188
Environmental Conditions	189
Preparing for the Installation	189
Providing Necessary Tools and Equipment	189
Taking ESD Precautions	189
Installing the Library	190
Locating the Mounting Position	190
Installing the Library.....	192
Loading the Tape Cartridges	207

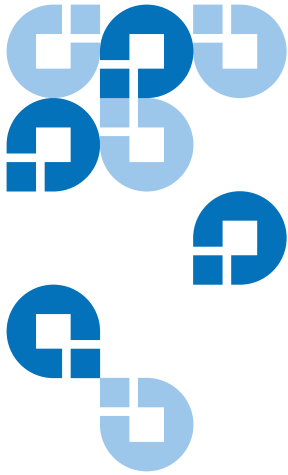

Figures

Figure 1	Scalar 50.....	2
Figure 2	Slot Numbering, Scalar 50 SDLT	3
Figure 3	Slot Numbering, Scalar 50 LTO.....	4
Figure 4	Scalar 50 Front Panel.....	8
Figure 5	Scalar 50 Internal Layout	10
Figure 6	Scalar 50 Back Panel.....	12
Figure 7	Multiple Library Stack (Cross Section.....	16
Figure 8	Rack Space Requirements	19
Figure 9	Connecting the Library to the Local Area Network	20
Figure 10	Inserting a Barcode Label (SDLT).....	25
Figure 11	SDLT Cartridges.....	26
Figure 12	LTO Cartridges.....	28
Figure 13	SDLT Cleaning Cartridges.....	29
Figure 14	LTO Cleaning Cartridges.....	29
Figure 15	Closing the Scalar 50 Front Doors.....	30
Figure 16	Scalar 50 Cable Configuration (SCSI Full Height Drives)....	32
Figure 17	Scalar 50 Cable Configuration (Native Fibre Channel Full Height Drives)	32

Figure 18	Scalar 50 Cable Configuration (SCSI Half-Height Drives)...	33
Figure 19	Scalar 50 Cable Configuration (SAS Half-Height Drives)....	33
Figure 20	Scalar 50 Cable Configuration (Native Fibre Channel Half-Height Drives).....	34
Figure 21	Scalar 50 Cable Configuration (Stacked).....	35
Figure 22	Turning On the Library	36
Figure 23	OCP Home Screen.....	38
Figure 24	OCP Component Tree.....	39
Figure 25	Info Screen	40
Figure 26	Overview Screen.....	41
Figure 27	Hardware Screen	42
Figure 28	Event Log Screen	43
Figure 29	Statistics Screen.....	44
Figure 30	Operations Screen.....	45
Figure 31	Library Operations Screen	46
Figure 32	Match Label Screen	47
Figure 33	Move From Screen.....	48
Figure 34	Drive Operations Screen	49
Figure 35	Setup Screen	51
Figure 36	Cabinet Setup Screen	51
Figure 37	Partitions Setup Screen	53
Figure 38	Security Screen.....	54
Figure 39	Network Screen	55
Figure 40	Date and Time Screen	57
Figure 41	Diagnostic Screen	57
Figure 42	System-level Test Screen	58
Figure 43	Subsystem Tests Screen	59
Figure 44	Component Tests Screen	60
Figure 45	Load Port Settings	62

Figure 46	Quantum Scalar 50 Web Page Menu Items	65
Figure 47	Quantum Tape Security and Tape Encryption Menus	66
Figure 48	Overview Page.....	67
Figure 49	Status Page	70
Figure 50	Hardware Status Page	71
Figure 51	Event Log Page	72
Figure 52	Statistics Page.....	76
Figure 53	Operations Page.....	77
Figure 54	Find Page	78
Figure 55	Move Page	81
Figure 56	Inventory Page.....	82
Figure 57	Drives Page.....	83
Figure 58	Setup Page	85
Figure 59	Users Page	87
Figure 60	Create Key User.....	89
Figure 61	Remove Secure User	89
Figure 62	Change Key User Password.....	90
Figure 63	SCSI Page.....	91
Figure 64	iSCSI Page.....	93
Figure 65	Network Page	94
Figure 66	Events Page	96
Figure 67	SNMP Section of Event Page	99
Figure 68	Date & Time Page.....	100
Figure 69	Library Page	101
Figure 70	Native Fibre Channel Partition Example.....	103
Figure 71	Partitions Page	105
Figure 72	Setup Wizard.....	109
Figure 73	Setup Wizard (Library Offline)	109
Figure 74	Setup Wizard (Date and Time).....	110

Figure 75	Setup Wizard (Configure Devices)	111
Figure 76	Setup Wizard (Configuring Load Ports).....	111
Figure 77	Setup Wizard (Configuring Partition).....	112
Figure 78	Setup Wizard (Wizard Completed)	113
Figure 79	Secure Key Page.....	114
Figure 80	Protection Mode for Cartridges.....	115
Figure 81	Enable/Disable Secure Key for Drives.....	116
Figure 82	Select Secure Key for Library	117
Figure 83	Assign Secure Key to Cartridge	117
Figure 84	Create Secure Key Name/Secure Key Pair	118
Figure 85	Delete Secure Key Name	119
Figure 86	Backup Secure Key File	120
Figure 87	Upload Secure Key File	121
Figure 88	Utilities Page	124
Figure 89	Library Page	125
Figure 90	Selftest Page.....	127
Figure 91	System Tests Page	128
Figure 92	Maintenance Page	129
Figure 93	Logs Page.....	132
Figure 94	View Log Page	132
Figure 95	Tasks Page	133
Figure 96	Task List Example	134
Figure 97	Reference Page.....	135
Figure 98	About Page	135
Figure 99	Location of the Reel Locks and the Hub	184
Figure 100	Opening the Tape Cartridge Door	185
Figure 101	Write Protect Switch	186
Figure 102	Rack Space Requirements	188
Figure 103	Rail Adapter Orientation.....	194

Figure 104	Assembling the Left-Hand Rack Mount Shelves.....	195
Figure 105	Assembling the Right-Hand Rack Mount Shelves	196
Figure 106	Installing the Rack Mount Shelves.....	197
Figure 107	Back Mounting Brackets.....	199
Figure 108	Installing the Scalar 50 in the Rack	200
Figure 109	Securing the Back of the Library	201
Figure 110	Scalar 50 Tape Drive Numbering.....	202
Figure 111	Scalar 50 Cable Configuration (SCSI Full Height Drives) ..	203
Figure 112	Scalar 50 Cable Configuration (Native Fibre Channel Full Height Drives).....	204
Figure 113	Scalar 50 Cable Configuration (SCSI Half-Height Drives) .	204
Figure 114	Scalar 50 Cable Configuration (SAS Half-Height Drives) ..	205
Figure 115	Scalar 50 Cable Configuration (Native Fibre Channel Half- Height Drives).....	205
Figure 116	Scalar 50 Cable Configuration (Stacked).....	206
Figure 117	Turning On the Library	208
Figure 118	Setup Screen	210
Figure 119	Library Options Screen.....	210
Figure 120	Date and Time Screen	211
Figure 121	Network Screen	212
Figure 122	Opening the Right and Left Magazine Access Doors	214
Figure 123	Removing the Magazines	215
Figure 124	Removing the Scalar 50 Library	219
Figure 125	Opening the Right and Left Magazine Access Doors	221
Figure 126	Installing the Hand Restraint.....	222
Figure 127	Installing the Restraining Bolt	223
Figure 128	Preparing the Library for Shipping	225
Figure 129	Setup Screen	227
Figure 130	Cabinet Screen	227
Figure 131	Connecting to the Library SCB.....	229

Figure 132 Overview Page..... 230
Figure 133 Utilities Page 231
Figure 134 Maintenance Page 232
Figure 135 Setup Screen 233
Figure 136 Cabinet Screen 233

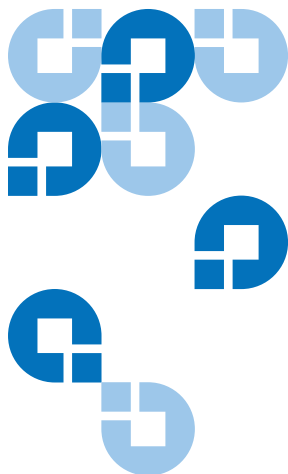

Tables

Table 1	DLT-S4 Performance Characteristics.....	5
Table 2	Quantum LTO-3 (Half- Height) Performance Characteristics	6
Table 3	HP LTO-3 (Full Height) Performance Characteristics	6
Table 4	HP LTO-4 (Half- Height) Performance Characteristics.....	7
Table 5	HP LTO-4 Performance Characteristics.....	7
Table 6	Front Panel Features	9
Table 7	Scalar 50 Capacity Levels	14
Table 8	Capacity, Scalar 50 Multiple Library Stack - LTO (42U High Rack)17	
Table 9	Capacity, Scalar 50 Multiple Library Stack - SDLT (42U High Rack).....	17
Table 10	Hardware Information	42
Table 11	Library Operations Options.....	46
Table 12	Drive Options	50
Table 13	Cabinet Setup.....	52
Table 14	Partitions Setup	53
Table 15	Security Setup	54

Table 16	Import/Export Option Settings.....	61
Table 17	Quick Status Library Health Conditions	68
Table 18	Quick Status Health Messages	68
Table 19	Statistics Information	74
Table 20	Identification Information.....	86
Table 21	User Information	88
Table 22	Native Fibre Channel Configuration Options.....	92
Table 23	Network Configuration Fields	95
Table 24	Email Notification	97
Table 25	Send Email Test	97
Table 26	SNMP Trap Selections	99
Table 27	Library Configuration.....	101
Table 28	Capacity on Demand Configuration	102
Table 29	Creating a Partition.....	106
Table 30	Configuration File Types.....	130
Table 31	Start-up Problems.....	165
Table 32	OCP Problems.....	166
Table 33	Robotics (Hand) Problems	167
Table 34	Problems During Library Operation	168
Table 35	OCP LED States	171
Table 36	SCSI SCB LED	172
Table 37	Surrogate SCB LED	173
Table 38	Fibre Channel SCB LED	174
Table 39	Power Supply LEDs	175
Table 40	Tape Drive LEDs	176
Table 41	Unit Dimensions/Weight	178
Table 42	Capacities.....	178
Table 43	Performance Specifications	179
Table 44	Library Performance	179

Table 45	Reliability Specifications	180
Table 46	Tape Drive Specifications.....	180
Table 47	Power	181
Table 48	Climate.....	181
Table 49	Rack Hole Types.....	190
Table 50	Scalar 50 Rail Hole Patterns and Mounting Positions	191
Table 51	Library Mounting Hardware.....	192
Table 52	Back Mounting Bracket Orientation.....	198
Table 53	Setting Up the Cabinet.....	211

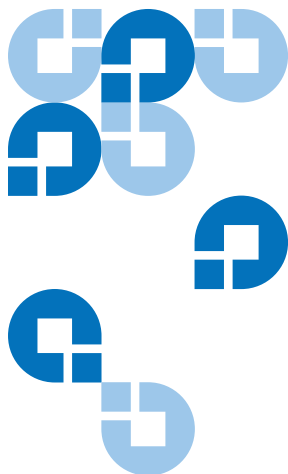

Preface

Audience

This document is written for operators of the Scalar 50 tape library.

Purpose

This document explains how to use the Scalar 50 tape library.

Document Organization

This document is organized as follows:

- [Chapter 1, Library Description](#), provides an overview of the Scalar 50 library.
- [Chapter 2, Basic Library Operations](#), introduces the library OCP screens and explains how to use them to perform basic library operations such as moving tape cartridges within the library, removing the tape cartridge magazines, and viewing library information.
- [Chapter 3, Quantum Scalar 50 Remote Management](#), explains how to change the library configuration and manage the library using the remote GUI.
- [Chapter 4, SNMP Trap List](#), lists the SNMP traps supported by the Scalar 50 library.
- [Chapter 5, Troubleshooting](#), discusses problems you may encounter during the setup and operation of the Scalar 50 library.

- [Appendix A, Specifications](#), lists the specifications for the Scalar 50 library.
- [Appendix B, SDLTtape Cartridge Maintenance](#), provides guidelines for handling SDLT cartridges and visually inspecting them if necessary.
- [Appendix C, Installing the Scalar 50 Library](#), provides installation information for the Scalar 50 library.
- [Appendix D, Repacking the Scalar 50 Library](#), provides repacking information for the Scalar 50 library.
- [Appendix E, Firmware Upgrade Instructions for Stacked Libraries](#), provides procedures for upgrading library firmware to stacked libraries.
- [Appendix F, Regulatory Statements](#), provides regulatory information for the Scalar 50 library.

This document concludes with a glossary and a detailed index.

Notational Conventions

This manual uses the following conventions:

Note: Notes emphasize important information related to the main topic.

Caution: Cautions indicate potential hazards to equipment and are included to prevent damage to equipment.

Warning: Warnings indicate potential hazards to personal safety and are included to prevent injury.

This manual uses the following:

- Right side of the library – Refers to the right side as you face the component being described.
- Left side of the library – Refers to the left side as you face the component being described.

Related Documents

Documents related to the Scalar 50 tape library are shown below:

Quantum Scalar 50 Documentation

Document No.	Title	Description
81-81767	<i>Scalar 50 Quick Start</i>	Provides information on installing the Scalar 50 library in a rack.
81-81769	<i>Scalar 50 Tape Drive Installation Instructions</i>	Provides information on installing tape drives in the Scalar 50 library.
81-81770	<i>Scalar 50 Tape Drive Replacement Instructions</i>	Provides information on replacing tape drives in the Scalar 50 library.
81-81539	<i>TC2201 iSCSI Bridge User's Guide</i>	Provides web and serial interface information for the TC2201 iSCSI bridge.
81-81771	<i>Scalar 50 Magazine Upgrade Instructions</i>	Provides installation information for both the SDLT and LTO tape magazines.
6311658	<i>SNMP Integration Guide</i>	Provides integration information for SNMP.
81-81627	<i>Scalar 50 Series DLTSage™ Secure Tape Quick Start Guide</i>	Provides information on creating secure keys on your library.

Refer to the appropriate product manuals for information about your tape drives and cartridges.

SCSI-2 Specification

The SCSI-2 communications specification is the proposed American National Standard for information systems, dated March 9, 1990. Copies may be obtained from:

Global Engineering Documents
15 Inverness Way, East
Englewood, CO 80112
(800) 854-7179 or (303) 397-2740

Contacts

Quantum company contacts are listed below.

Quantum Corporate Headquarters

To order documentation on the DXi7500 or other products contact:

Quantum Corporation (*Corporate Headquarters*)
1650 Technology Drive, Suite 700
San Jose, CA 95110-1382

Technical Publications

To comment on existing documentation send e-mail to:

doc-comments@quantum.com

Quantum Home Page

Visit the Quantum home page at:

<http://www.quantum.com>

Getting More Information or Help

StorageCare™, Quantum's comprehensive service approach, leverages advanced data access and diagnostics technologies with cross-environment, multi-vendor expertise to resolve backup issues faster and at lower cost.

Accelerate service issue resolution with these exclusive Quantum StorageCare services:

- **Service and Support Website** - Register products, license software, browse Quantum Learning courses, check backup software and operating system support, and locate manuals, FAQs, firmware downloads, product updates and more in one convenient location. Benefit today at: <http://www.quantum.com/ServiceandSupport/index.aspx>
- **eSupport** - Submit online service requests, update contact information, add attachments, and receive status updates via email. Online Service accounts are free from Quantum. That account can also be used to access Quantum's Knowledge Base, a comprehensive repository of product support information. Sign up today at: <http://www.quantum.com/ServiceandSupport/eSupport/Index.aspx>.
- **StorageCare Guardian** - Securely links Quantum hardware and the diagnostic data from the surrounding storage ecosystem to Quantum's Global Services Team for faster, more precise root cause diagnosis. StorageCare Guardian is simple to set up through the internet and provides secure, two-way communications with Quantum's Secure Service Center. More StorageCare Guardian information can be found at: <http://www.quantum.com/ServiceandSupport/Services/GuardianInformation/Index.aspx>.

For further assistance, or if training is desired, contact Quantum Technical Assistance Center:

North America: +1-800-284-5101

UK, France and Germany 00800 4 QUANTUM

EMEA +44 1256 848 766

For worldwide support: <http://www.quantum.com/ServiceandSupport/eSupport/Index.aspx>

StorageCare Guardian



StorageCare Guardian is a remote monitoring and diagnostic solution that enables Quantum to proactively monitor the health of Quantum products, use diagnostic data to predict possible failures, and determine whether or not the problem involves a Quantum product or other critical component in the environment.

Benefits

StorageCare Guardian gives the customer added assurance that Quantum will make sure its products are running optimally to ensure maximum operational efficiency. Deploying this solution is easy and enables customers to minimize the costs associated with system downtime and service issues should a problem arise.

More Reliable Backups

Through continuous 24x7x365 monitoring, **StorageCare Guardian** proactively checks Quantum systems for common errors and alerts the customer when a Quantum product is underperforming. By proactively identifying red flags, the risk of failed backups and machine downtime can be mitigated.

Faster Resolution Time

When the system is down, **StorageCare Guardian** provides the necessary diagnostics data that enables Quantum to identify the root cause and expedite the problem resolution process. Problems that used to take days to fix can now be fixed in minutes. When problems require onsite support, field engineers will have better information along with the right parts necessary to fix the problem.

StorageCare Guardian allows Quantum to

- Monitor diagnostic data related to Quantum products
- Receive alarms that notify Quantum of issues at the customer site
- Run diagnostic utilities to more quickly determine the root cause of issues

- Initiate remote connection to remote management interface to get more in-depth information about the health of your Quantum product.
- Distribute software/firmware upgrades - this will be available as a future enhancement

Product Features

- Continuous Monitoring - Proactive 7x24x365 monitoring of Quantum products enabling Quantum Support to be alerted on events such as errors or marginal conditions that are defined by the user.
- Root Cause Diagnosis - Allows Quantum to quickly isolate and identify the root cause of a problem.
- Rapid Problem Resolution- Quantum can rapidly recommend and/or implement the corrective actions needed to resolve a problem ensuring minimal impact to the IT environment.
- Quantum Remote Software Update - Distributed software update capability allows fast updates to agent software and Quantum hardware installed at customer sites
- Real-time Data Collection - Instant on-demand or scheduled diagnostic data collection from Quantum products as well as the ability to run user-defined data collection scripts from agent.
- Access Management - Customer has full control over Quantum's access rights and privileges.
- Audit Logging - Audit logs are kept for all communications to and from the agent.

How it works:

- 1 Customers can download the **StorageCare Guardian** agent software from <http://www.quantum.com/guardiandownload>.
- 2 Customer installs the **StorageCare Guardian** agent on any Windows 2000/2003/XP or Solaris 8/9 server located at the customer's site.
- 3 The **StorageCare Guardian** agent monitors Quantum products, and provides information and updates to the Quantum Enterprise Server that resides at Quantum Support.

- 4 If an error or problem is detected, Quantum queues a request to the **StorageCare Guardian** agent for data collection or real-time access to the system.
- 5 The **StorageCare Guardian** agent checks access policy settings to determine if access is allowed.
- 6 If approved, the information is transferred to Quantum, or a remote connection is initiated.
- 7 Quantum Support will diagnose the problem and, if necessary, send the needed parts and/or field personnel to resolve the issue.
- 8 Quantum can identify if the backup problem is not associated with the Quantum device and then direct the customer to resolve the issue with appropriate third-party vendor.

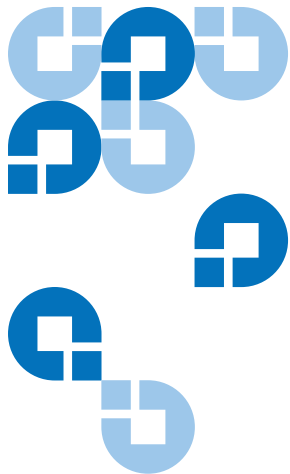

Chapter 1

Library Description

This chapter provides an overview of the Scalar 50 and is divided into the following sections:

- [Overview](#)
- [Tape Drives](#)
- [Library Features](#)
- [DLTSage™ Tape Security](#)
- [Mixed Media Support](#)
- [Capacity on Demand](#)
- [Library Scalability \(Stacked Configurations\)](#)
- [Getting Started](#)

Overview

The Quantum Scalar 50 tape library (see [figure 1](#)) is an automated tape storage and retrieval device that may consist of up to 4 tape drives and up to 32 SDLT or 38 LTO tape cartridges. Cartridges are stored in two removable cartridge magazines and two fixed slots. Both SDLT and LTO tape cartridges can be installed in a single library as long as the appropriate magazines and drives are installed.

Figure 1 Scalar 50



	# Tape Drives	# Magazines	# Fixed Slots	# Cartridges
SDLT	0 - 2	2 (15 slots per magazine)	2	32
LTO	0 - 4	2 (18 slots per magazine)	2	38

Figure 2 Slot Numbering,
Scalar 50 SDLT

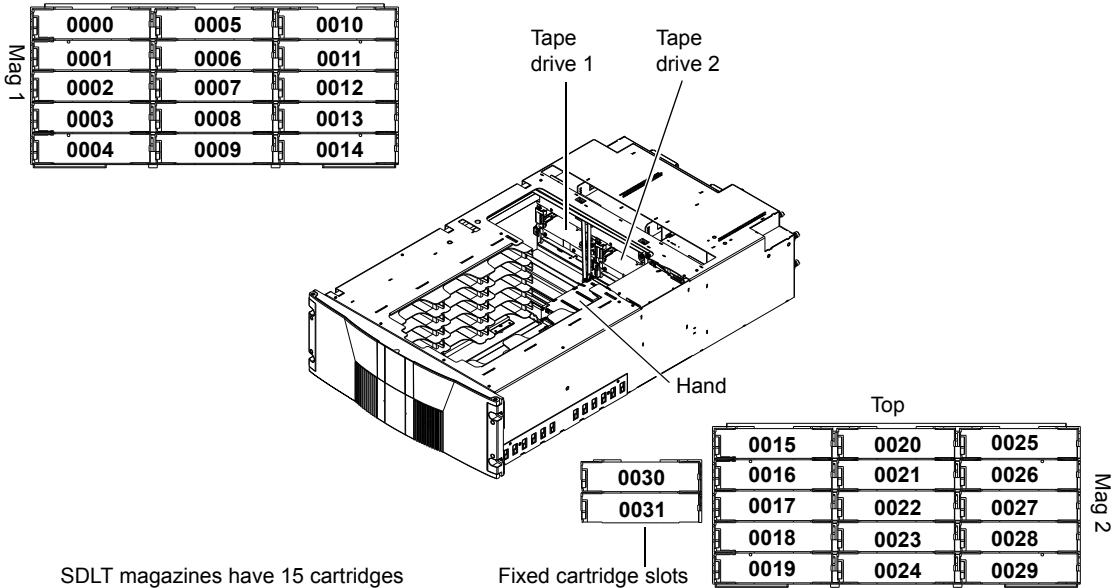
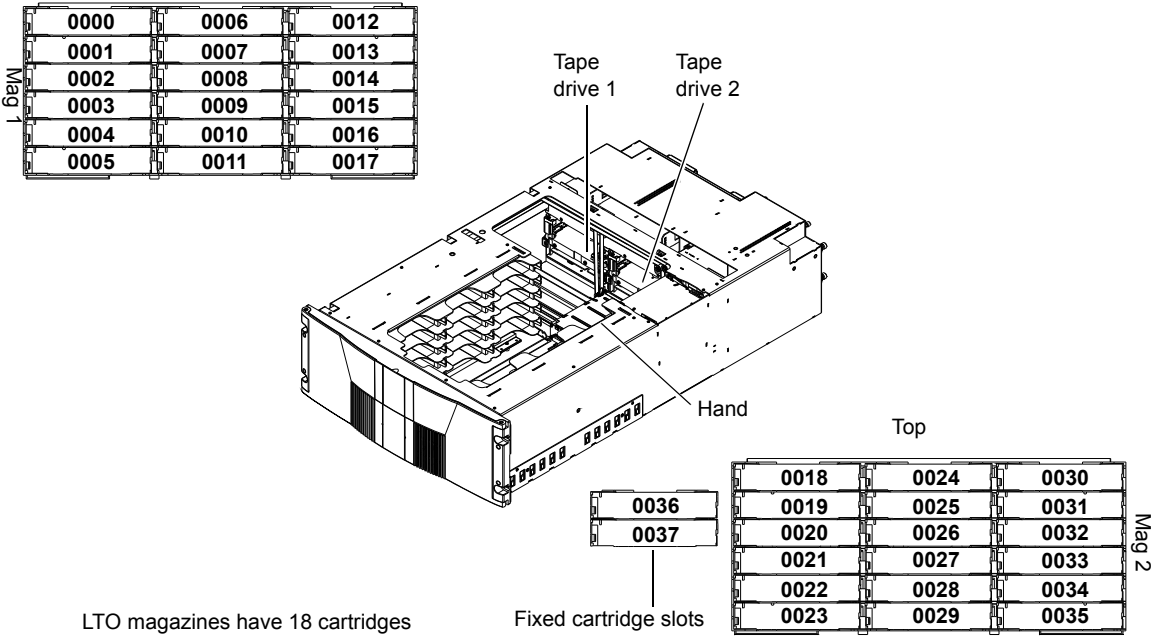

Figure 3 Slot Numbering,
Scalar 50 LTO



Tape Drives

Scalar 50 tape libraries are equipped with either SCSI or native Fibre Channel tape drives. SCSI buses are SCSI-2 fast/wide (8/16 bit), Ultra 3 SCSI, Ultra 160, or Ultra 320 SCSI, depending on the drives installed.

LVD SCSI configurations have a maximum allowable bus length of 12 meters. To determine the cable length of the bus, measure the lengths of the SCSI cables connecting each device to that bus and add those lengths together. To that total length, add 12.25 inches (31.10 cm) for the internal SCSI cable length of each SCSI tape drive.

Tape Drive Types



The Scalar 50 tape library support the following tape drives:

- Quantum DLT-S4 (SCSI and Native Fibre Channel)
- Quantum Half-Height LTO-3 (SCSI and Native Fibre Channel)
- HP LTO-3 (SCSI and Native Fibre Channel)
- HP LTO-4 (SCSI and Native Fibre Channel)
- HP Half-Height LTO-4 (SAS)

Scalar 50 library can support mixed media types, mixed interface types (Fibre Channel and SCSI) as well as mixed form factors within the same library. Example: The Scalar 50 can contain both LTO full height drives with LTO half-height drives in the same library.

Refer to the following tables for tape drive performance characteristics. Both SDLT and LTO tape drive can exist in the same library as long as the appropriate magazines are installed in the library.

Table 1 DLT-S4 Performance Characteristics

Quantum Scalar 50 DLT-S4 Model (drives/slots)	2/32
Capacity in Terabytes (TB) (800 GB per cartridge)	25.6
*Compressed Capacity in TB (1600 GB per cartridge)	51.2
Throughput (GB/hr) based on 60 MB/sec transfer rate (2 tape drives installed)	432
*Compressed Throughput (GB/hr) based on 120 MB/sec transfer rate (2 tape drives installed)	864

* Compressed capacity assumes a 2:1 compression ratio.

Table 2 Quantum LTO-3 (Half-Height) Performance Characteristics

Quantum Scalar 50 Quantum LTO-3 Half-Height Model (drives/slots)	4/38
Capacity in Terabytes (TB) (400 GB per cartridge)	15.2
*Compressed Capacity in TB (800 GB per cartridge)	30.4
Throughput (TB/hr) based on 80 MB/sec transfer rate (4 tape drives installed)	1.1
*Compressed Throughput (TB/hr) based on 160 MB/sec transfer rate (4 tape drives installed)	2.3

* Compressed capacity assumes a 2:1 compression ratio.

Table 3 HP LTO-3 (Full Height) Performance Characteristics

Quantum Scalar 50 HP LTO-3 Model (drives/slots)	2/38
Capacity in Terabytes (TB) (400 GB per cartridge)	15.2
*Compressed Capacity in TB (800 GB per cartridge)	30.4
Throughput (TB/hr) based on 80 MB/sec transfer rate (2 tape drives installed)	.576
*Compressed Throughput (TB/hr) based on 160 MB/sec transfer rate (2 tape drives installed)	1.1

* Compressed capacity assumes a 2:1 compression ratio.

Table 4 HP LTO-4 (Half-Height) Performance Characteristics

Quantum Scalar 50 HP LTO-4 Half-Height Model (drives/slots)	1/38
Capacity in Terabytes (TB) (800 GB per cartridge)	30.4
*Compressed Capacity in TB (1600 GB per cartridge)	60.8
Throughput (TB/hr) based on 80 MB/sec transfer rate (4 tape drives installed)	1.1
*Compressed Throughput (TB/hr) based on 160 MB/sec transfer rate (4 tape drives installed)	2.3

* Compressed capacity assumes a 2:1 compression ratio.

Table 5 HP LTO-4 Performance Characteristics

Quantum Scalar 50 HP LTO-4 Model (drives/slots)	2/38
Capacity in Terabytes (TB) (800 GB per cartridge)	30.4
*Compressed Capacity in TB (1600 GB per cartridge)	60.8
Throughput (TB/hr) based on 120 MB/sec transfer rate (2 tape drives installed)	.864
*Compressed Throughput (TB/hr) based on 240 MB/sec transfer rate (2 tape drives installed)	1.7

If a drive experiences read/write errors when the **AutoClean** function is enabled, the library issues an error message stating that drive cleaning is required. Without user intervention, the library hand replaces the data cartridge with a cleaning cartridge. When the cleaning procedure finishes, the library hand returns the data cartridge to the drive.

Note: When a cleaning cartridge has completed its 20-use limit, it is automatically exported from the library, requiring a new one to be loaded through the load port.

Library Features

Front Panel

[Figure 4](#) illustrates the features of the Scalar 50 library front panel. These features are described in [table 6](#).

Figure 4 Scalar 50 Front Panel

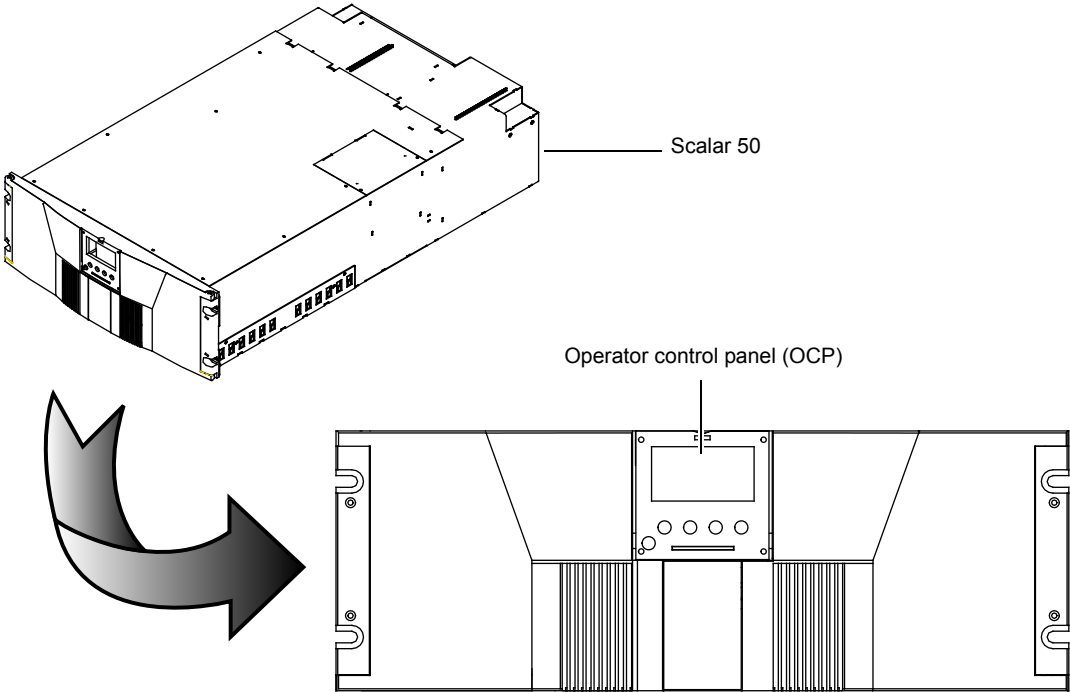

Table 6 Front Panel Features

Feature	Description
Operator control panel (OCP)	<p>The operator control panel consists of the following elements:</p> <ul style="list-style-type: none"> <li data-bbox="304 395 1299 491">• OCP display The OCP displays library status information and allows you to access the library menus. These menus allow you to view or change the library settings and run diagnostic tests. The OCP is discussed in detail in chapter 2. <li data-bbox="304 560 1282 716">• Five OCP buttons These buttons in combination with the OCP are used to scroll through screens and select options or commands. The functionality of these buttons changes depending on the currently displayed OCP screen. The power button is used to turn the library on and off. <li data-bbox="304 743 1160 960">• Light emitting diode (LED) indicator The operator control panel has one LED indicators: <ul style="list-style-type: none"> <li data-bbox="568 795 1003 821">• Steady green - indicates a idle state <li data-bbox="568 838 1032 864">• Flashing green - indicates a busy state <li data-bbox="568 881 1103 907">• Flashing amber - indicates an attention state <li data-bbox="568 925 975 951">• Steady amber - indicates an error
Magazine access doors	These doors protect the data cartridge magazines.

Internal Layout

[Figure 5](#) illustrates the internal layout of a Scalar 50 library.

Figure 5 Scalar 50 Internal Layout

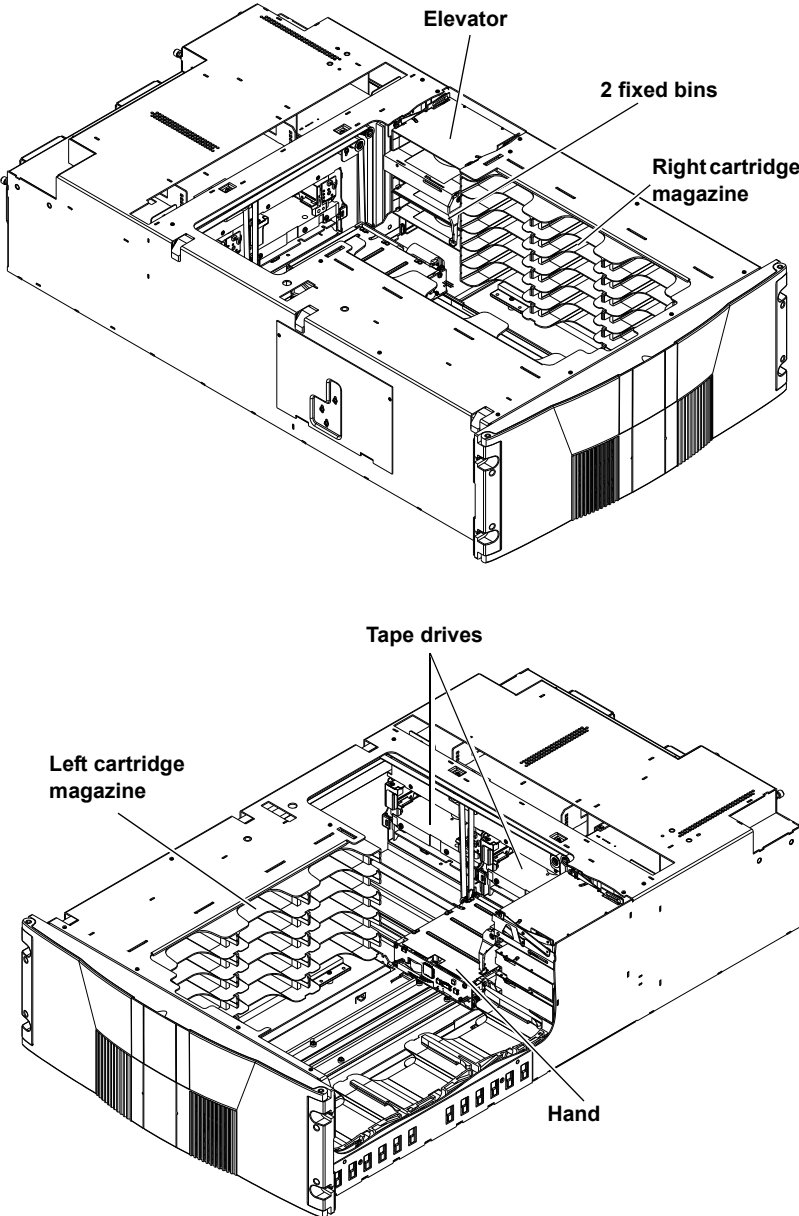

Each cartridge magazine holds 15 SDLT cartridges or 18 LTO cartridges. The bins in the left magazines are numbered from 1 through 15 (18 in LTO libraries) from front to back. The bins in the right magazines are numbered from 1 through 15 (18 in LTO libraries) from back to front. The Scalar 50 has two fixed slots behind the right magazine.

A bar code reader is attached to the library's robotic hand. This bar code reader automatically identifies the cartridges in the library, if the cartridges are fitted with acceptable bar code labels.

Back Panel

The library back panel provides access to the following items:

- [System Controller Board \(SCB\)](#)
- [Power Supplies](#)
- [CPCI Card Cage](#)
- [Tape Drives](#)

System Controller Board (SCB)

The system controller board (SCB) contains the library firmware and processor. Two Ethernet ports. One port for remote management and the other for internal communications with add-on CPCI cards such as the TC2201 iSCSI bridge.

Power Supplies

The power supplies provide redundant power to the library. The Scalar 50 can contain up to two power supplies (one power supply in the base unit).

CPCI Card Cage

The CPCI (compact PCI) card cage provides space for option cards such as the TC2201 iSCSI bridge. The Scalar 50 can contain one option card.

Tape Drives

The Scalar 50 can contain up to four tape drives.

<p>Warning: Hazardous Moving Parts. Keep Fingers and Other Body Parts Away When Removing and Installing Tape Drives.</p>	<p>Warnung: Gefährliche bewegliche Teile. Halten Sie die Finger und andere Körperteile weg, wenn Sie Bandlaufwerke entfernen und anbringen.</p>
---	--

Figure 6 illustrates the back panel of the Scalar 50 library.

Figure 6 Scalar 50 Back Panel

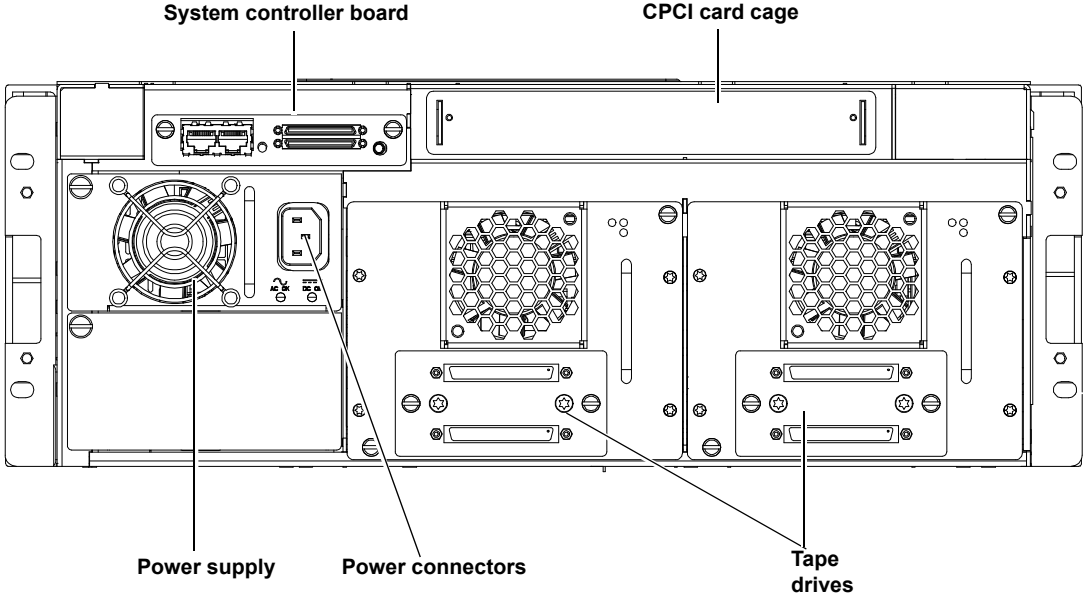

DLTSage™ Tape Security



The Scalar tape library with DLT-S4 tape drives are capable of utilizing DLTSage Tape security. DLTSage Tape Security is a unique solution designed to prevent unauthorized access to tape cartridges which is particularly valuable when protecting tapes that are transported offsite. DLTSage Tape Security is a firmware feature designed into the DLT-S4 tape drive which uses an electronic key to prevent or allow reading and writing of data on to a tape cartridge. This key is managed through the remote management pages of the Scalar 50 tape library (see [chapter 3, “Quantum Scalar 50 Remote Management,”](#)). DLTSage Tape Security is available at no additional cost as an integrated feature in of the DLT-S4 tape drive and Scalar 50 tape library.

Mixed Media Support

The Scalar 50 tape library is capable of supporting mixed media (SDLT and LTO media) and a mixture of tape drives in the same library frame. You must have at least one magazine type (SDLT or LTO) for each tape drive type (SDLT or LTO).

Capacity on Demand

Capacity on demand provides the ability to upgrade the storage capacity of a library by using a software capacity key that grants access to additional magazine slots. The Scalar 50 library has two capacity levels (see [table 7](#)):

- **Level 1** - default capacity (four magazine columns starting with the three columns of the left-hand magazine and including the back column of the right-hand magazine)
- **Level 2** - full capacity (all six columns of the left and right magazines and all physical slots in the system including stacked libraries)

The two fixed slots located in every library are always available for use.

Table 7 Scalar 50 Capacity Levels

Capacity Level	Licensed Capacity (Slot Count)	
	LTO	SDLT
Level 1	26	22
Level 2	38	32

Note: Partitioning cannot be used unless all libraries are at **FULL** capacity.

Note: If your libraries are in a stacked configuration, all libraries must be at **FULL** capacity. PX502 libraries are automatically at full capacity.

Contact your Quantum Sales representative to acquire additional license keys.

Enabling Capacity on Demand

If your Quantum Scalar 50 has not already been enabled with the full slot capacity, you must complete the following procedure:

- 1 Retrieve and record the Scalar 50 library serial number.
- 2 Access the COD website and follow the instructions by providing the Library serial number to obtain your new License Key for your additional capacity purchase.

The COD website URL is: www.quantum.com/capacity/scalar50.

- 3 Record your new License Key and then install it into the Library to increase your slot capacity (see [Library](#) on page 101 for more information on enabling capacity on demand).

Library Scalability (Stacked Configurations)

The Scalar 50 library modules can be used as stand-alone libraries, or combined with other Scalar 50 library modules in a standard 19-inch rack to form a larger library system (called a multiple library stack). The multiple library or stacked configuration appears as a single large capacity library (or multiple libraries if partitioned) to the host (see [figure 7](#)).

Multiple Library Stack Requirements

To ensure the proper operation of your multiple library stack, review the following list of multiple library stack requirements:

- Multiple library stacks that contain a Scalar 50 can NOT exceed two library cabinets.
- The Scalar 50 must be the Master library in a multiple library stack containing PX502 libraries.
- The Master library must always be in the bottom most position in the library stack.
- If a Scalar 50 is stacked with PX502 libraries, the PX502 can NOT contain an HP LTO-2 tape drive or a FC1202 Fibre Channel bridge. These devices are not supported by Scalar 50.
- All Scalar 50 libraries must have full capacity enabled.
- A library that contains SAS drives cannot be shared with SCSI or Fibre Channel libraries.
- If your Scalar 50 is not already enabled with full slot capacity, you must initially configure the Scalar 50 libraries and enable **Full** capacity with a **Capacity Key** before configuring the cabinets as Master and Slave libraries (see [Library](#) on page 125 for more **Capacity Key** information).

Figure 7 Multiple Library
Stack (Cross Section)

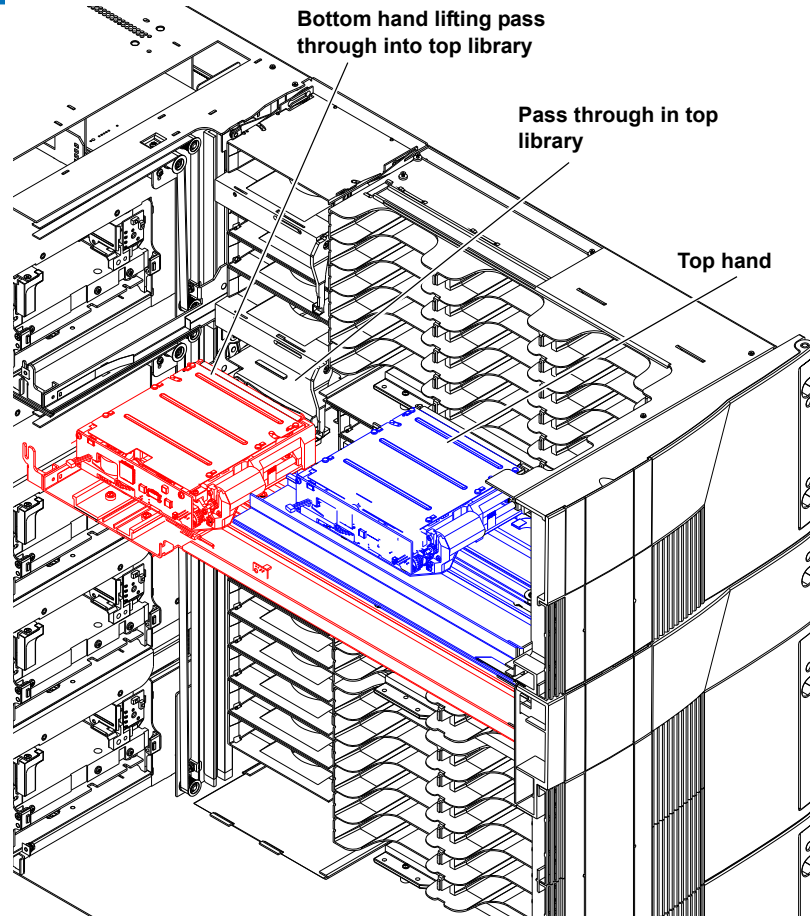

[Table 8](#) lists the capacities of all the sizes of multiple library stacks created using LTO Scalar 50 library modules. [Table 9](#) lists the capacities of all the sizes of multiple library stacks created using SDLT Scalar 50 library modules.

Table 8 Capacity, Scalar 50
Multiple Library Stack - LTO
(42U High Rack)

# of Scalar 50 Library Modules	Max. # of Tape Drives	# of Cartridges*	Capacity (in TB)			
		LTO	Quantum/HP LTO Gen 3		HP LTO Gen 4	
			Native	Compressed [†]	Native	Compressed [†]
1	2 full height/ 4 half height	38	15.2	30.4	32	64
2	4 full height/ 8 half height	76	28.8	57.6	64	128

*.The values in the # of Cartridges and Capacity columns assume that all the magazines and fixed cartridge slots are fully populated with data cartridges.

[†]Compressed values assume 2:1 compression ratios.

Table 9 Capacity, Scalar 50
Multiple Library Stack - SDLT
(42U High Rack)

# of Scalar 50 Library Modules	Max. # of Tape Drives	# of Cartridges*	Capacity (in TB)*	
		SDLT	DLT-S4	
			Native	Compressed [†]
1	2 full height/ 4 half height	32	26.4	52.8
2	4 full height/ 8 half height	64	52.8	105.6

*.The values in the # of Cartridges and Capacity columns assume that all the magazines and fixed cartridge slots are fully populated with data cartridges.

[†]Compressed values assume 2:1 compression ratios.

Getting Started

This chapter describes the procedures necessary to get your Quantum Scalar 50 library up and running. Have the following equipment and accessories available before installing the library:

- SCSI cables to support 1 host bus adapter (HBA) per two tape drives
- SCSI, SAS, or Fibre Channel HBAs in the host
 - 2 tape drives per SCSI bus

Note: Quantum ships sufficient SCSI cables and terminators with the libraries to set up two-drives per SCSI bus. One tape drive per SCSI bus may be necessary for optimum performance. Refer to your tape drive documentation.

- Power source (see [appendix A](#) on page 177 for power requirements)
- Tape cartridges (LTO and/or SDLT)

After the Quantum Scalar 50 is in its final location, the following steps are required to complete the installation:

- [Installing the Quantum Scalar 50](#)
- [Cabling the Quantum Scalar 50 Series](#)
- [Loading Tape Cartridges](#)
- [Initial Configuration](#)

Installing the Quantum Scalar 50

The Scalar 50 library modules fit into a standard 19-inch wide rack. Refer to [figure 8](#) for rack space requirements. Complete mounting information is provided in the *Quantum Scalar 50 Series Quick Start* (PN 81-81767).

Figure 8 Rack Space Requirements

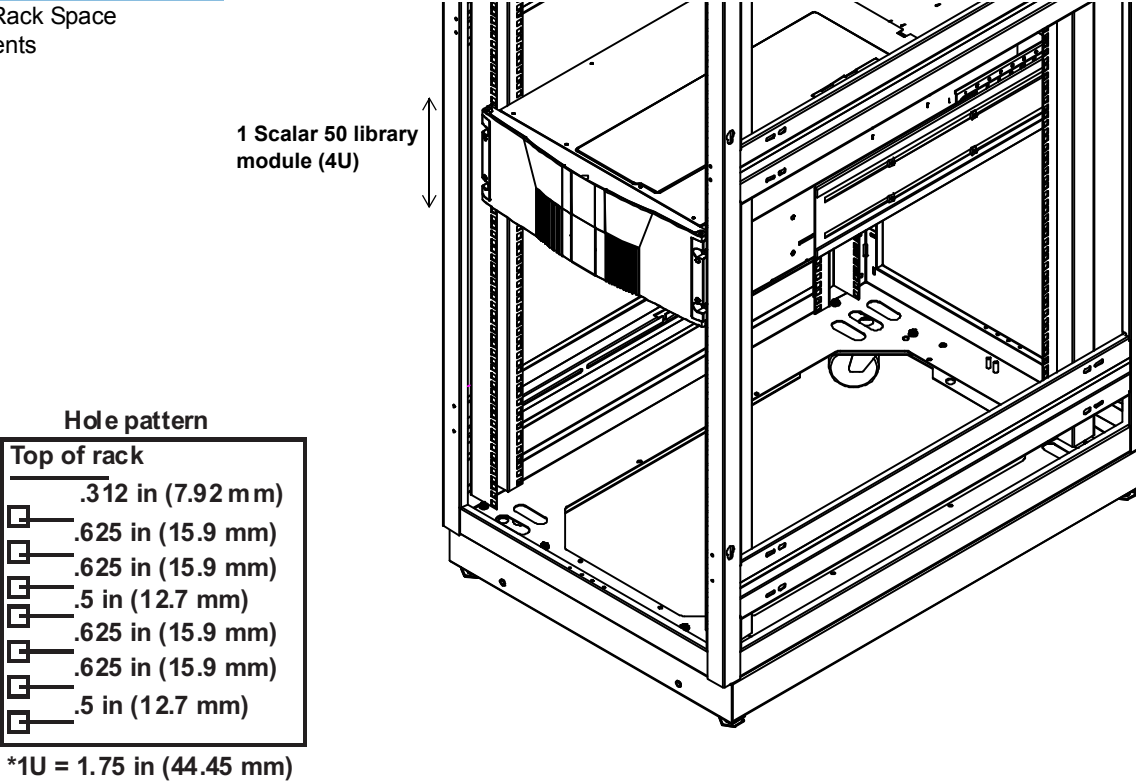

Warning: If the rack is empty at the time of installation, do NOT install the Scalar 50 modules too high in the rack. The combined weight of the components may cause the rack to become “top heavy” and unstable if installed in the top of an empty rack. If installing a multiple library stack, begin installing the bottom library module first.

Cabling the Quantum Scalar 50 Series

After the Quantum Scalar 50 is in its final location, the tape drives and system controller board must be connected to the backup host system(s).

To cable the Quantum Scalar 50:

- 1 The Scalar 50 tape drives and system controller board are accessed from the back of the library (refer to [Connecting to Host Workstations](#) on page 31).
- 2 Connect Ethernet port located on the back of the library on the system controller board to the local area network (see [figure 9](#)).

Figure 9 Connecting the Library to the Local Area Network

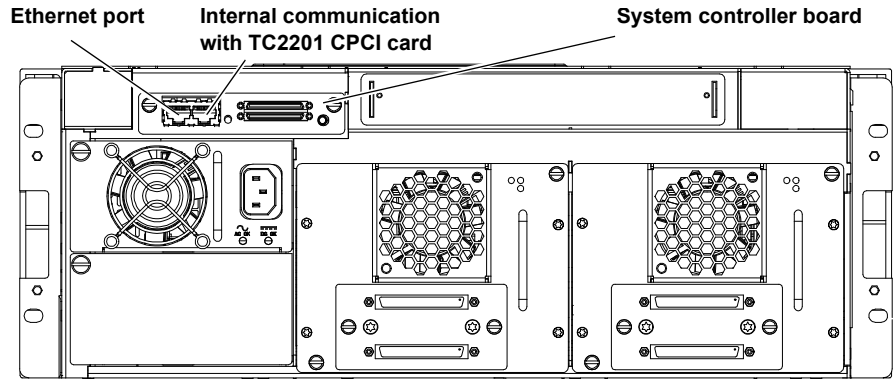

Loading Tape Cartridges

Before operating the library, load the appropriate tape cartridges (LTO or SDLT) into the library starting with the left-hand magazine (see [figure 2](#) and [figure 3](#) for slot locations).

Initial Configuration

The Quantum Scalar 50 must be initially configured with an IP address before the remote management software is available. Refer to [Using the OCP](#) on page 37 for information on configuring your Scalar 50 network information and preparing for operation.

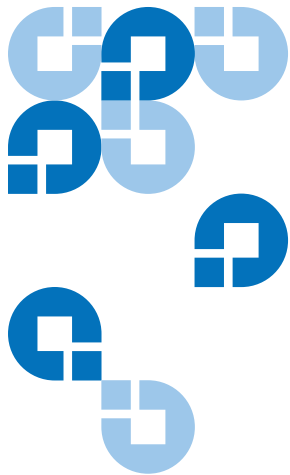

Basic Library Operations

This chapter describes the following basic library operating procedures:

- [Installing Tape Cartridges](#)
- [Preparing the Library for Operation](#)
- [Turning the Library On and Off](#)
- [Using the OCP](#)
- [Load Port Configuration](#)

Installing Tape Cartridges

To install tape cartridges:

- 1 Label each cartridge (see [“SDLT Cartridges”](#) on page 24 and [“LTO Cartridges”](#) on page 26 for information on cartridge labels).
- 2 Set the write-protect switch to either write protect or write enable (see [“SDLT Cartridges”](#) on page 24 and [“LTO Cartridges”](#) on page 26 for information on write-protect switches).

- 3 Place cartridges (right side up) in the fixed slots and magazines:
 - a Open the library doors (see [“Library Operations”](#) on page 45 to open the library doors).
 - b Remove the magazines (see [“Library Operations”](#) on page 45 to release the magazines).

Note: You have approximately 10 seconds to open the doors and remove the magazines. If you did not complete the operation, repeat the steps.

- c Load the tape cartridges in the magazines and fixed bins. It is recommended to start loading tape cartridges in magazine 1, bin 0000 (see [figure 2](#) on page 3 and [figure 3](#) on page 4 for magazine and bin locations).

Warning: Do NOT reach into the library to load tape cartridges into the fixed bins. Use the **Move** page located on the **Operations** tab from the remote management pages (see [chapter 3](#) on page 63) to move tape cartridges from the magazines into the fixed bins.

- d Replace the magazines in the library.
- e Close the library doors.

Caution: Placing the cartridges in the bins upside down can cause damage to the library (see [figure 11](#) for SDLT cartridges and [figure 12](#) for LTO cartridges).

Caution: Handle tape cartridges with care. Do not drop or bang them, or place them near sources of electromagnetic interference. Rough handling can displace the tape leader, making the cartridge unusable and potentially hazardous to the tape drives. If a tape is dropped, discard and replace with a new tape. Loss of data could result from damaged tape cartridges inserted in tape drives.

Taking ESD Precautions

Components within the Scalar 50 contain static-sensitive parts. To prevent damage to these parts while performing installation, maintenance, or replacement procedures, observe the following precautions:

- Keep the cabinet turned off during all installation, maintenance, and replacement procedures.
- Keep the cabinet power cord connected to a grounded power outlet except when working with AC electrical components.

Warning: Avoid contact with the power supplies, EMI filter, and all other AC electrical components while the cabinet is connected to a power outlet.



Unplug all AC cords to remove power from equipment.

- Use an antistatic wrist strap when touching internal cabinet components. To use the wrist strap properly, place the band around your wrist and attach the clip to the cabinet frame. Keep the strap on until you are ready to close the cabinet doors.
- Keep static-sensitive parts in their shipping containers until ready for installation.
- Do not place static-sensitive parts on any metal surface. If you need to put down a static-sensitive part, place it inside its protective shipping bag or on a grounded antistatic mat.
- Avoid direct contact with static-sensitive parts. Avoid touching connectors and discrete components.
- Close cabinet door and access panel when not working on the cabinet.

- Be very careful when installing the cabinet or handling components in dry climates or environments where cold weather heating is used. Environments such as these with lower relative humidity have greater potential to produce static electricity.

Note: In environments with high potential for static electricity, take additional precautions such as the use of an antistatic smock or a grounded antistatic mat.

SDLT Cartridges

The following section shows you how to label SDLT tape cartridges, as well as setting the write-protect switch and proper orientation.

Note: Quantum highly recommends using barcode labels provided by Quantum. Also, use the appropriate barcode labels for your drive type. Do not use older barcode labels on tape cartridges for newer drive types.

Labeling

The Scalar 50 is a multi-media library, meaning multiple drive and tape cartridge types can be present in a single library. Barcode labels are attached to each tape cartridge to differentiate the different tape cartridge types (SDLT, LTO, and cleaning cartridges).

The SDLT cartridge label has eight characters (e.g. AAANNNS#). The first six characters are called the volume identifier which is made up of three alpha characters and three numeric characters. These characters allow each cartridge to have a unique identifier. The last two characters are called the media identifier and indicate the following media types:

- V4 = DLT-V4
- S1 = SDLT 220
- S2 = SDLT 320
- S3 = SDLT 600
- S4 = DLT-S4

Note: You cannot choose the sequence of labels inside the bar code label packs. No two packs are ever the same to avoid issues with duplicate bar code IDs.

Place the label in the slide-in slot on the front of the cartridge (see [figure 10](#)).

Figure 10 Inserting a Barcode Label (SDLT)

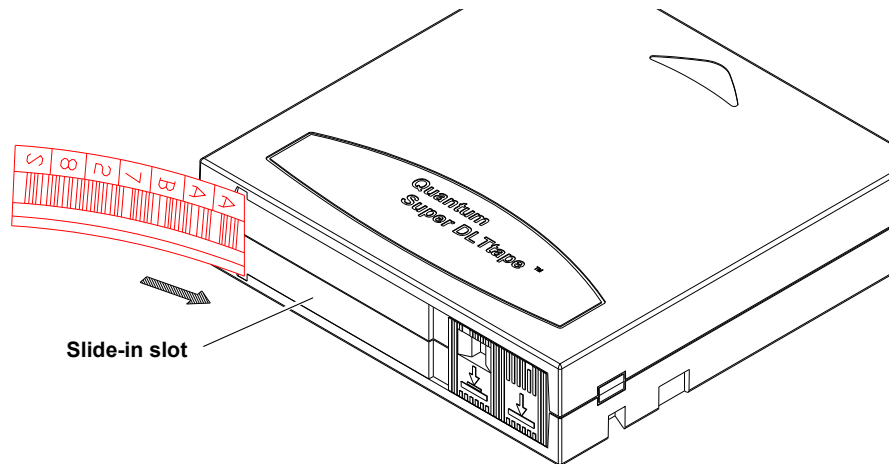

Note: Only use barcode labels that have been designed for cartridges. Do not adhere labels to a cartridge anywhere except the slide-in slot.

Setting the Write-Protect Switch

Each tape cartridge has a write-protect switch similar to that shown in [figure 11](#). This switch determines whether new data can be written to the cartridge (*write-enabled*) or whether data on the cartridge is protected from being erased or overwritten (*write-protected*). Set the write-protect switch to enabled when inserting new cartridges into the library. Set the write-protect switch to protected archiving tape cartridges.

Proper Insertion Orientation

Refer to [figure 11](#) for proper label placement, write protection settings and insertion orientation.

Figure 11 SDLT Cartridges

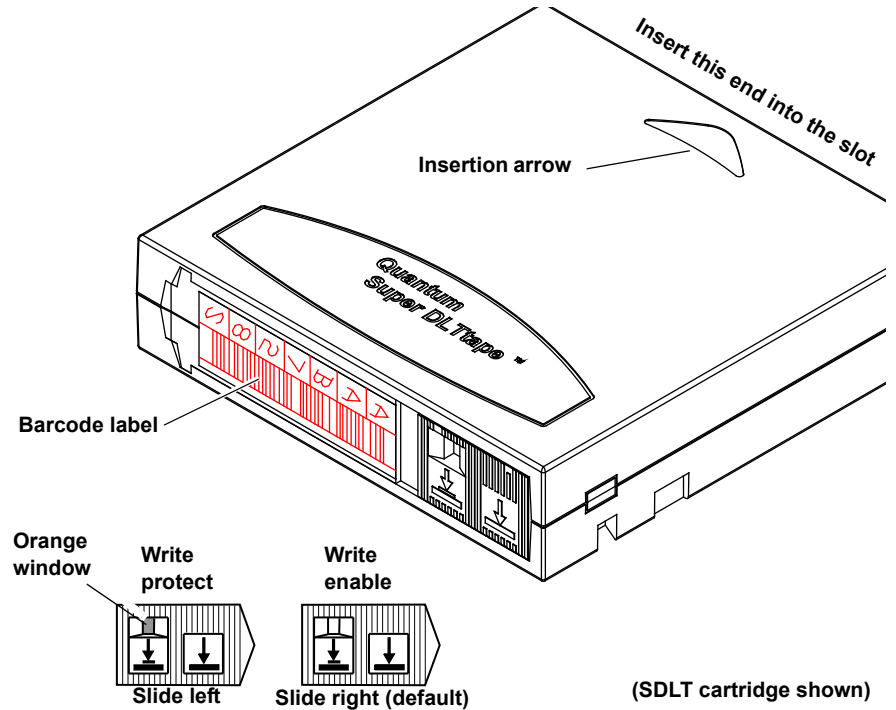

LTO Cartridges

LTO tape cartridges are different in size to the SDLT cartridges as well as in the barcode labeling and write-protect switch setting (see [figure 12](#)).

Note: Quantum highly recommends using barcode labels provided by Quantum. Also, use the appropriate barcode labels for your drive type. Do not use older barcode labels on tape cartridges for newer drive types.

Labeling

The Scalar 50 is a multi-media library, meaning multiple drive and tape cartridge types can be present in a single library. Barcode labels are attached to each tape cartridge to differentiate the different tape cartridge types (SDLT, LTO, and cleaning cartridges).

The LTO cartridge label has eight characters (e.g. AAANNL#). The first six characters are called the volume identifier which is made up of three alpha characters and three numeric characters. These characters allow each cartridge to have a unique identifier. The last two characters are called the media identifier and indicate the following media types:

- L1 = LTO generation 1 (LTO)
- L2 = LTO generation 2 (LTO-2)
- L3 = LTO generation 3 (LTO-3)
- L4 = LTO generation 4 (LTO-4)

Note: You cannot choose the sequence of labels inside the bar code label packs. No two packs are ever the same to avoid issues with duplicate bar code IDs.

Adhesive-backed barcode labels are used on LTO tape cartridges. Refer to [figure 12](#) for proper label placement, write protection settings and insertion orientation.

Figure 12 LTO Cartridges

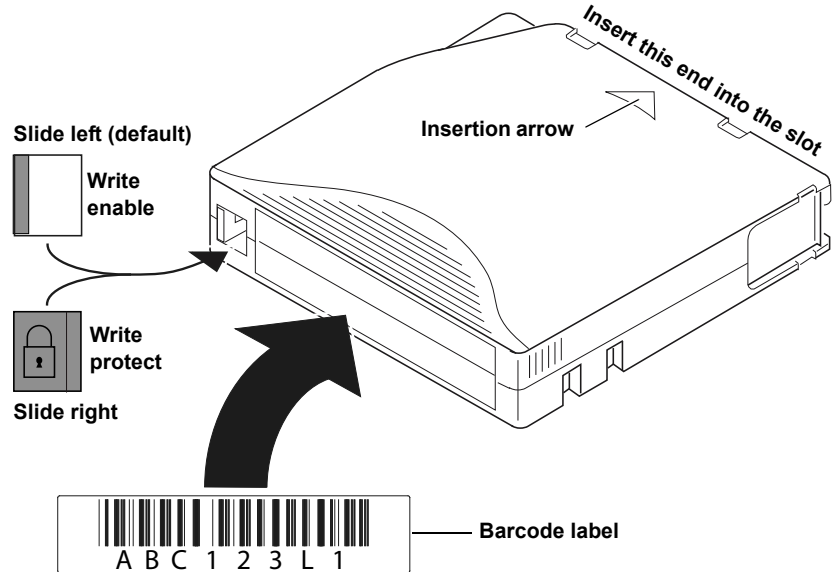

Caution: LTO tape drive media cannot be degaussed due to the fact that it uses "magnetic servos." Do not attempt to degauss LTO tape drive media. If this media is degaussed, it will no longer work.

Cleaning Cartridges

Cleaning cartridges are used when a tape drive within the library requires cleaning. When Autoclean is enabled (either through the OCP or remote management screens), the library will automatically clean the tape drive when needed. A fixed bin (see [figure 2](#) on page 3 and [figure 3](#) on page 4 for bin locations) is generally used to store a cleaning cartridge, however, the cartridge can be placed anywhere in the library. When the library completes the inventory, the system stores the cleaning cartridge location so it will be available when a tape drive requires cleaning.

Note: You must attach the appropriate cleaning cartridge barcode label (SDLT or LTO) to the cleaning cartridge or the library will mark it as unrecognizable media.

SDLT and LTO cleaning cartridge labels begin with CLN (see [figure 13](#) for SDLT and [figure 14](#) for LTO):

- SDLT cleaning cartridge labels are in the following format:
CLN###S#
- LTO cleaning cartridge labels are in the following format:
CLN###L#

Figure 13 SDLT Cleaning Cartridges



Figure 14 LTO Cleaning Cartridges

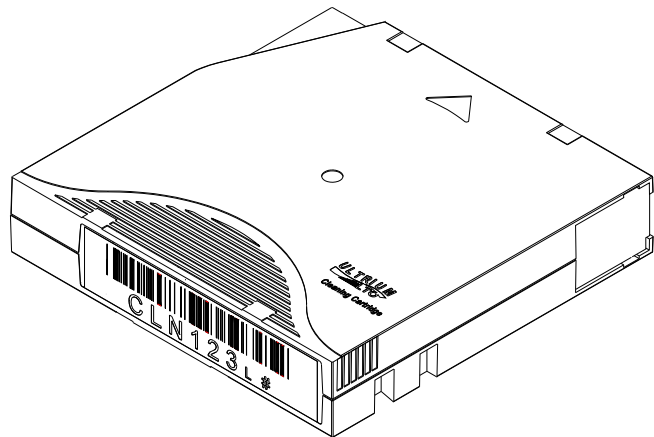

Preparing the Library for Operation

To prepare the cabinet for operation:

- [Close the Cabinet Doors and Access Panels](#)
- [Connecting to Host Workstations](#)

Close the Cabinet Doors and Access Panels

The Scalar 50 library has doors covering the tape cartridge magazines.

- 1 Close the front doors until they latch (see [figure 15](#))

Figure 15 Closing the Scalar 50 Front Doors

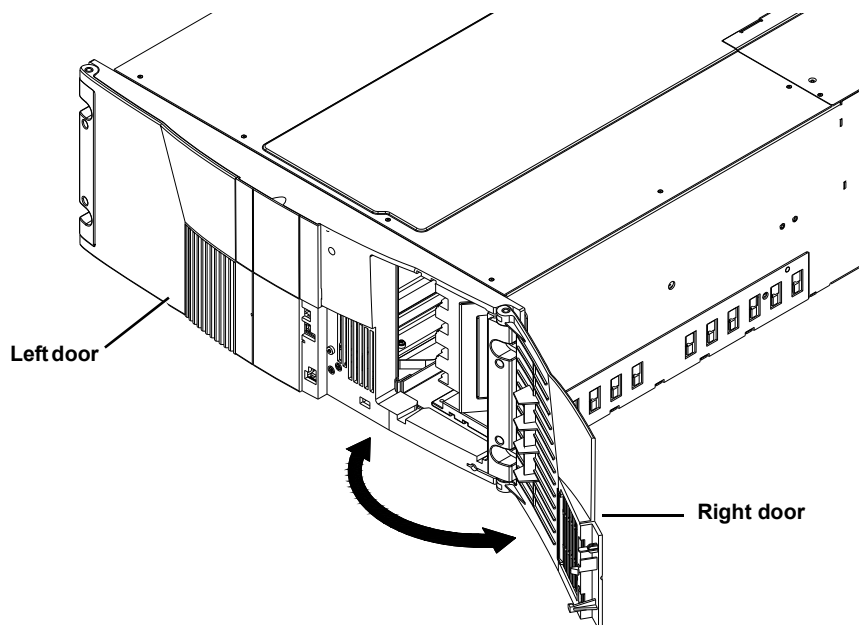

Connecting to Host Workstations

Connect the SCSI, SAS or Fibre Channel cables as shown in the following figures:

- [Scalar 50 Cable Configuration \(SCSI Full Height Drives\)](#)
- [Scalar 50 Cable Configuration \(Native Fibre Channel Full Height Drives\)](#)
- [Scalar 50 Cable Configuration \(SCSI Half-Height Drives\)](#)
- [Scalar 50 Cable Configuration \(SAS Half-Height Drives\)](#)
- [Scalar 50 Cable Configuration \(Native Fibre Channel Half-Height Drives\)](#)

Note: Quantum ships sufficient SCSI cables and terminators with the libraries to set up two-drives per SCSI bus.

Caution: The SCSI cables used to connect to the library system controller board **MUST** have an offset connector. Using a straight-in SCSI connector may damage the system controller board.

Stacked Configuration

- [Scalar 50 Cable Configuration \(Stacked\)](#)

Figure 16 Scalar 50 Cable Configuration (SCSI Full Height Drives)

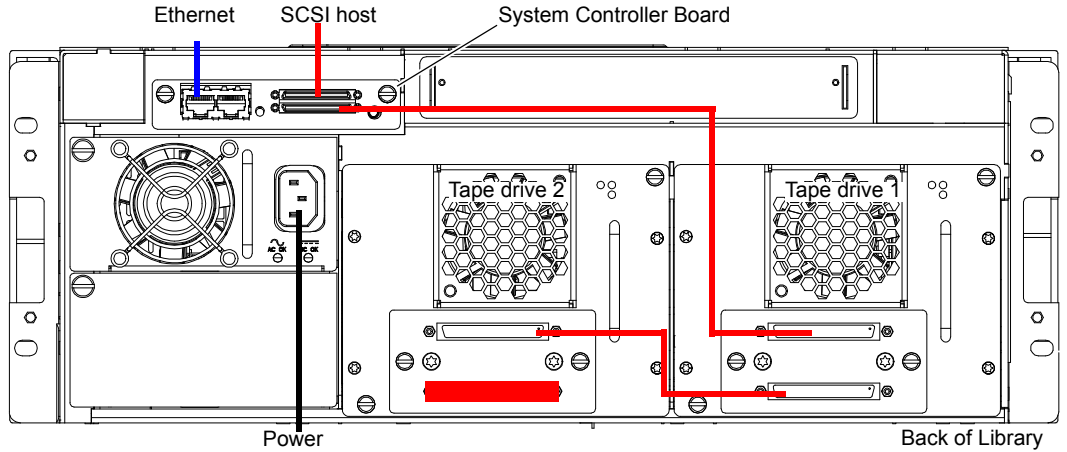

Figure 17 Scalar 50 Cable Configuration (Native Fibre Channel Full Height Drives)

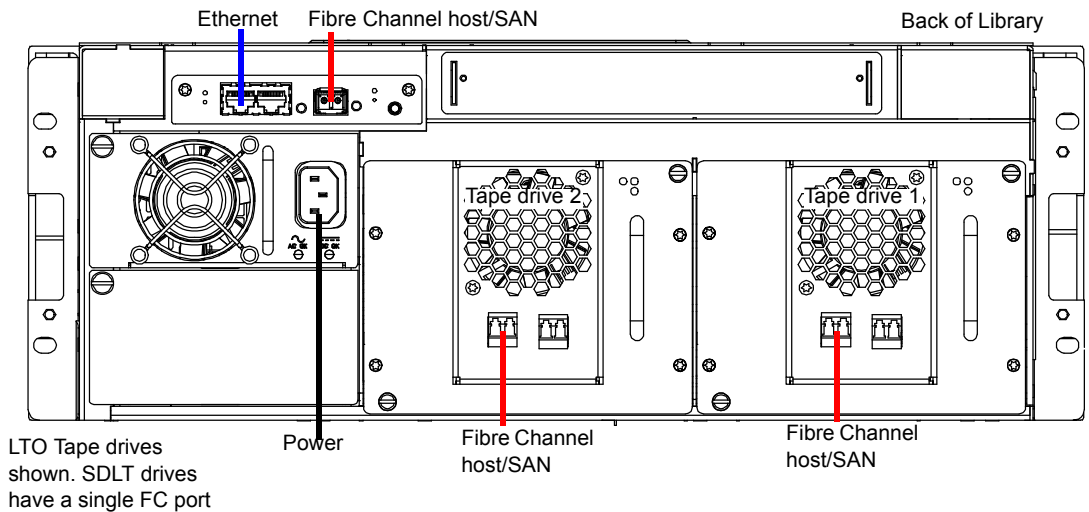

Figure 18 Scalar 50 Cable Configuration (SCSI Half-Height Drives)

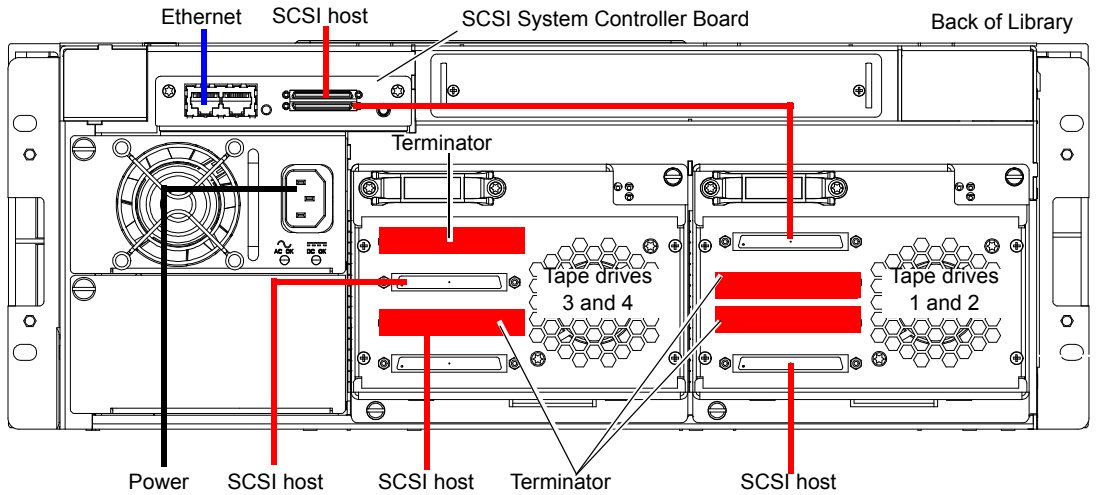

Figure 19 Scalar 50 Cable Configuration (SAS Half-Height Drives)

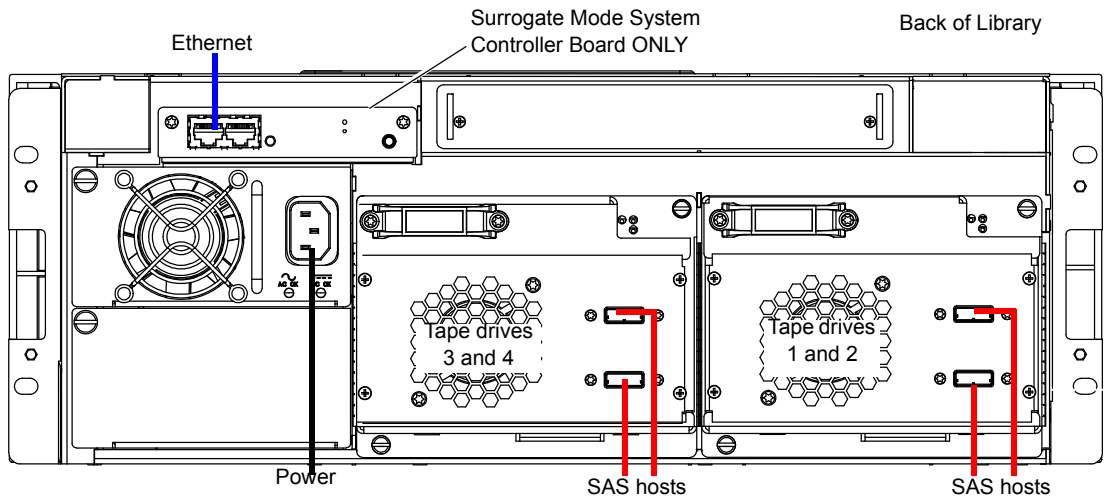

Figure 20 Scalar 50 Cable Configuration (Native Fibre Channel Half-Height Drives)

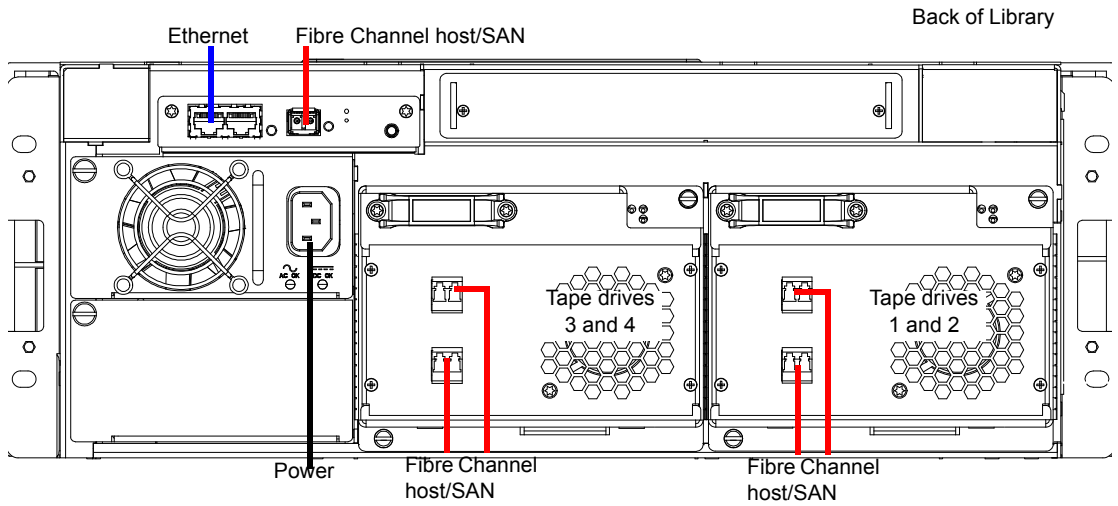
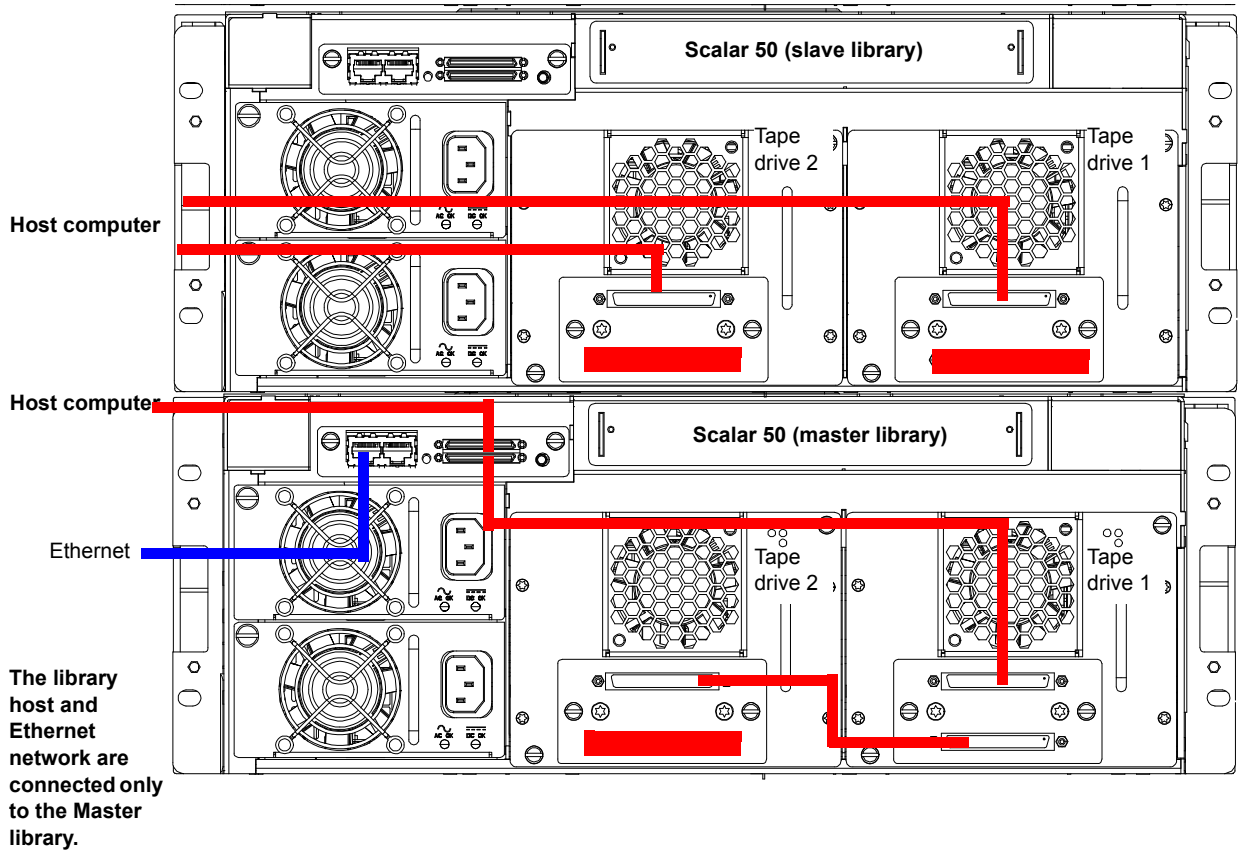

Figure 21 Scalar 50 Cable Configuration (Stacked)



Turning the Library On and Off

This section explains:

- [Turning On the Library](#)
- [Turning Off the Library](#)
- [Placing the Library On-line or Off-line](#)

Turning On the Library

To turn on the library:

- 1 Verify that:
 - Power cables are firmly in place
 - All doors are closed
- 2 Push the power button located in the lower left-hand corner of the OCP (see [figure 22](#)).

During the power up sequence, the library performs an inventory. The power up sequence can take several minutes.

Figure 22 Turning On the Library

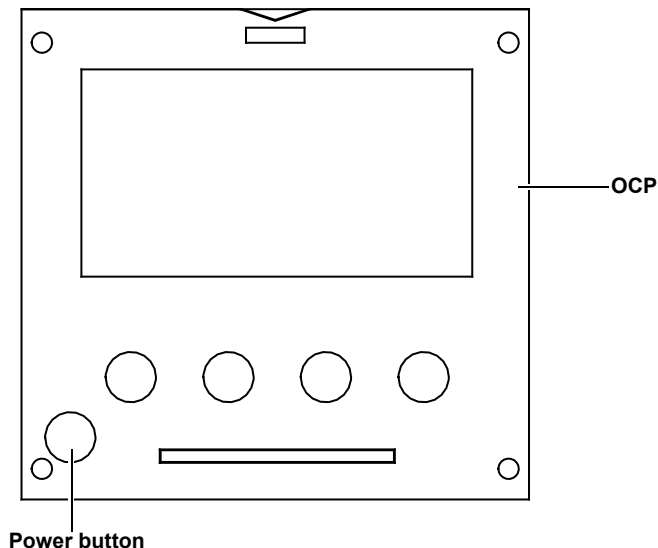

Turning Off the Library

To turn off the library:

- 1 Push the power button located on the front of the library and hold for approximately 1 second (see [figure 22](#)).

The library begins the shutdown sequence. The shutdown sequence can take up to two minutes to complete.

Placing the Library On-line or Off-line

With the library turned on, press the button corresponding to **Ops** on the OCP to access the **Operations** screen. Select **Library Operations** and then **Library on/offline** to turn the library off-line. Select Yes or No to confirm the library state change. For more information on the **Operations** screen, see "[Library Operations](#)" on page 45.

Using the OCP

The operator control panel (OCP) is located on the front of the library. The menus on the OCP allow you to obtain information about the library, execute library commands, and test library functions. Before using the OCP to perform library functions, familiarize yourself with the:

- [Home Screen](#)
- [OCP Buttons](#)

Home Screen

The first screen the OCP displays after library initialization is the main screen. This screen displays library status and provides information on the number of tape drives, slots, and serial number (see [figure 23](#)).

Figure 23 OCP Home Screen

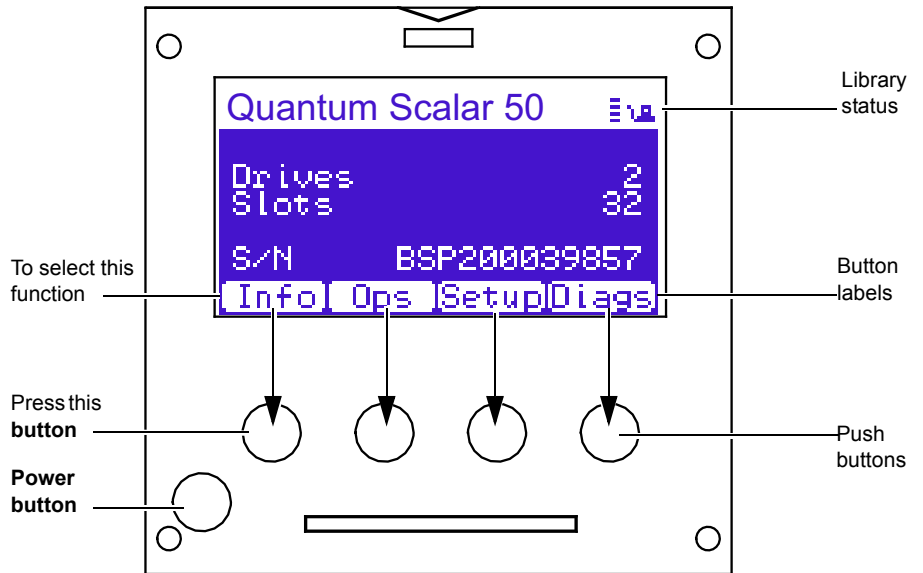

OCP Buttons

At the bottom of each OCP screen are four button labels. These labels indicate the functions of the four push buttons below the OCP. To select a function, press the push button directly below the button label on the OCP screen. The OCP also contains a power button for turning the library on and off.

OCP Components

The OCP allows the user to perform various functions on the Quantum Scalar 50 library. [Figure 24](#) provides a list of the OCP functionality available from the **Home** screen.

Figure 24 OCP Component Tree

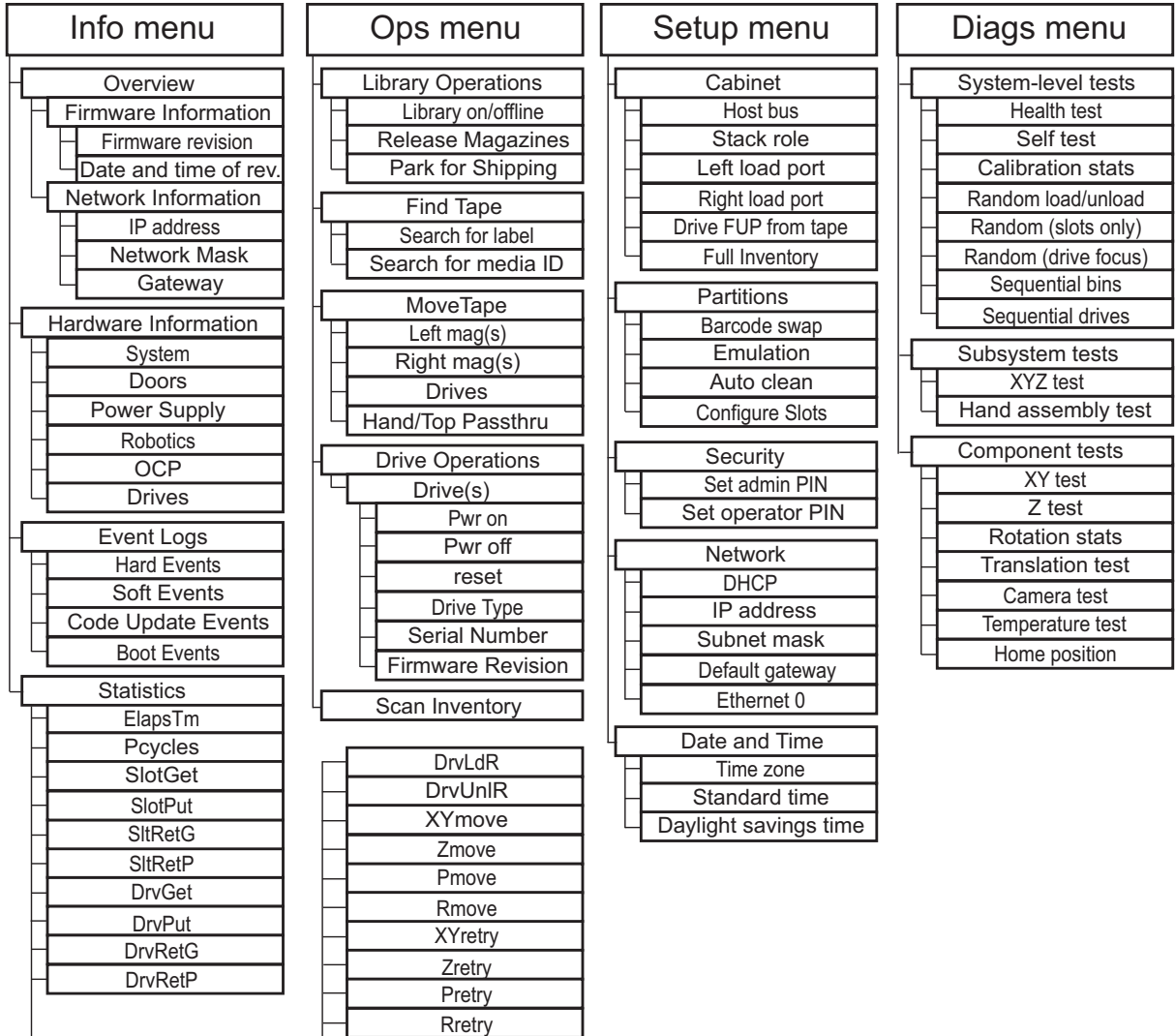

The following sections provide information on each function available from the Quantum Scalar 50 OCP:

- [Info Screen](#)
- [Operations Screen](#)
- [Setup Screen](#)
- [Diags Screen](#)

Info Screen

The **Info** screen provides access to library information such as hardware status, event logs, and statistics.

To access the **Info** screen, press **Info** from the **Home** screen. The OCP displays the **Info** screen (see [figure 25](#)):

Figure 25 Info Screen



The **Info** screen provides the following choices:

- [Overview Information](#)
- [Hardware Information](#)
- [Event Logs](#)
- [Statistics Information](#)

Overview Information

To view overview information:

- 1 From the **Info** screen, use the up and down arrows to highlight **Overview** and press **Enter**.

The **Overview** screen displays (see [figure 26](#)):

Figure 26 Overview Screen

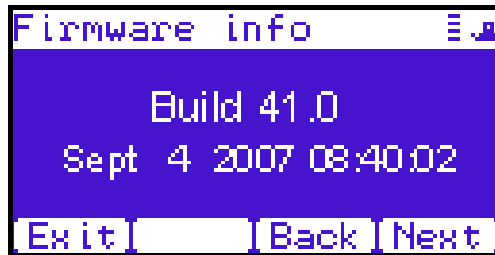

The **Overview** screen displays the following information about the library:

- Firmware revision
 - Time and date the firmware was built
- 2 Press **Back** or **Next** to review the network information such as the current IP address, network mask, and gateway information.
 - 3 When you are finished viewing overview information, press **Exit** to return to the **Info** screen.

Hardware Information

To view hardware information:

- 1 From the **Info** screen, use the up and down arrows to highlight **Hardware** and press **Enter**.

The **Hardware** screen displays (see [figure 27](#)):

Figure 27 Hardware Screen



The **Hardware** screen displays the following information (see [table 10](#)):

Table 10 Hardware Information

Hardware Information	Description
System	System information displays the overall sensor details for the library.
Doors	Door information displays the door sensor details.
Power Supply	Power supply information displays the power supply sensor details.
Robotics	Robotics information displays the robotic sensor details.
OCP	OCP information displays the OCP sensor details.
Drives	Drives information displays the tape drive sensor details.

- 2 Use the up and down arrows to highlight the information you wish to display and press **Enter**.
- 3 When you are finished viewing the hardware information, press **Exit** to return to the **Info** screen.

Event Logs

To view the event logs:

- 1 From the **Info** screen, use the up and down arrows to highlight **Event Logs** and press **Enter**.

The **Event Log** screen displays (see [figure 28](#)).

Figure 28 Event Log Screen

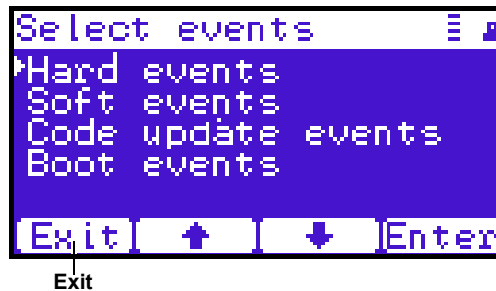

- 2 Use the up and down arrows to highlight the event type you wish to view (**Hardware**, **Software**, **Code updates**, or **Boot events**).

The OCP displays the event severity list.

- 3 Use the up and down arrows to highlight the severity type you wish to view (**All**, **Critical**, **Warning**, and **Informational**).

The OCP displays the event or list of events in the specific severity category. Use the Back and Next buttons to move between events.

- 4 When you are finished viewing the event logs, press **Exit** to return to the **Info** screen. Refer to [chapter 4](#) on page 137 for detailed event information.

Statistics Information

To view statistics information:

- 1 From the **Info** screen, use the up and down arrows to highlight **Statistics** and press **Enter**.

The **Statistics** screen displays (see [figure 29](#)):

Figure 29 Statistics Screen

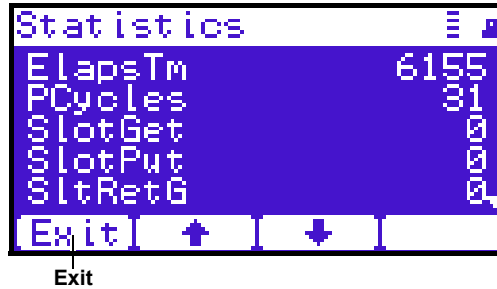

The **Statistics** screen displays the following information about the library:

- ElapsTm – seconds since boot.
- PCycles – total number of power cycles or reboots.
- SlotGet – count of cartridge retrievals from slots.
- SlotPut – count of cartridge deliveries to slots.
- SltRetG – count of retries in retrievals from slots.
- SltRetP – count of retries in deliveries to slots.
- DrvGet – count of cartridge retrievals from drives.
- DrvPut – count of cartridge deliveries to drives.
- DrvRetG – count of retries in retrievals from drives.
- DrvRetP – count of retries in deliveries to drives.
- DrvLdR – count of retries for cartridge loads in drives.
- DrvUnlR – count of retries for cartridge unloads in drives.
- XYmove – count of horizontal moves.
- Zmove – count of vertical moves.
- Pmove – count of extension moves.
- Rmove – count of rotation moves.

- XYretry – count of horizontal move retries.
- Zretry – count of vertical move retries.
- Pretry – count of extension move retries.
- Rretry – count of rotation move retries.

When you are finished viewing the statistics information, press **Exit** to return to the **Info** screen.

Operations Screen

The **Operations (Ops)** screen allows the user to view the status and issue commands to the cabinet and tape drives.

To access the **Operations** screen, press **Ops** from the **Home** screen. The OCP displays the **Operations** screen (see [figure 30](#)):

Figure 30 Operations Screen



The **Ops** screen provides the following choices:

- [Library Operations](#)
- [Find Tape](#)
- [Move Tape](#)
- [Drive Operations](#)
- [Scan Inventory](#)

Library Operations

To view library operations information:

- 1 From the **Ops** screen, use the up and down arrows to highlight **Library Operations** and press **Enter**.

The **Library Operations** screen displays (see [figure 31](#)):

Figure 31 Library Operations Screen



The following library operations options are available (see [table 11](#)):

Table 11 Library Operations Options

Library Operations Options	Description
Library on/offline	<p>When the cabinet is online, the library is ready for host communication and for backup jobs to proceed. When the cabinet is offline, the host is no longer able to communicate with the library. Self tests, diagnostics, and inventory can only be performed when the library is offline.</p> <p>Use the up and down arrows to highlight Library on/offline and press Enter to toggle the library online or offline. Press Yes to confirm the command or No to cancel.</p>
Release magazines	<p>Use the up and down arrows to highlight Release magazines and press Enter to view the release magazines screen. Select the magazine you wish to release and press Enter. Press Exit to cancel.</p> <p>Note: If there are no magazines installed or if the magazines are configured as load ports, this line will not display.</p>

Library Operations Options	Description
Park for shipping	<p>Note: You must remove all tape cartridges from the library prior to parking the library robotics for shipment.</p> <p>Use the up and down arrows to highlight Park for shipping and press Enter to move the robot to a safe position for transport. After the robot is in it's final position, the library shuts down. After the library is shut down, you must complete the repacking procedure before transporting the library (see appendix D on page 216).</p>

- 2 When you are finished viewing the library operations information, press **Exit** to return to the **Ops** screen.

Find Tape

To view media or tape cartridge information:

- 1 From the **Ops** screen, use the up and down arrows to highlight **Find Tape** and press **Enter**.

The **Match Label** screen displays (see [figure 32](#)):

Figure 32 Match Label Screen

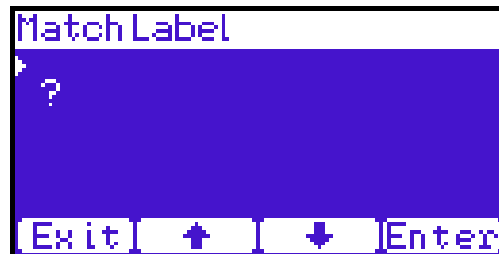

- 2 Use the up and down arrows to cycle through the alpha, numeric, or wildcard (?) characters to enter the tape cartridge label. After each character, press **Enter**.

If a match is found, the cartridge type and location displays.

- 3 If more than one match is found, a list of matching cartridges displays. Select the tape cartridge from the list and press **Enter**.

The tape cartridge type and location displays.

Move Tape

To view the move tape screen:

- 1 From the **Ops** screen, use the up and down arrows to highlight **Move Tape** and press **Enter**.

The **Move From** screen displays (see [figure 33](#)):

Figure 33 Move From Screen



To move a tape cartridge within the library:

Note: If this is a master library in a multiple library stack, you cannot move cartridges from one library into another. You can only move cartridges manually from one library into another via the remote management pages (see [chapter 3](#) on page 63).

- 2 Use the up and down arrows to select a magazine, tape drive, or fixed slot group and press **Enter**.

The **Move from** screen displays a list of storage bins within the selected magazine, tape drive, fixed slot group, and hand/top passthru.

- 3 Use the up and down arrows to select a tape cartridge from an occupied bin and press **Enter**.

The **Move** to screen displays a list of magazine, tape drive, or fixed slot groups.

- 4 Use the up and down arrows to select a magazine, tape drive, or fixed slot group to receive the cartridge and press **Enter**.

The **Move to** screen displays a list of storage elements within the selected magazine, tape drive, or fixed slot group.

- 5 Use the up and down arrows to select an empty bin to receive the tape cartridge and press **Enter**.

The **Move in progress** screen displays. When the tape cartridge has completed the move, a **Success** screen displays.

- 6 When you are finished moving tape cartridges, press **Exit** to return to the **Ops** screen.

Drive Operations

To perform a drive operation:

- 1 From the **Ops** screen, use the up and down arrows to highlight **Drive Operations** and press **Enter**.

The **Drive Operations** screen displays (see [figure 34](#)):

Figure 34 Drive Operations Screen



- 1 Use the up and down arrows to select a tape drive and press **Enter**.

The following drive options are available (see [table 12](#)):

Caution: Ensure that the tape drive does not contain a tape cartridge prior to powering down the tape drive.

Table 12 Drive Options

Device Options		Description
Drive	Pwr on	This option powers on a specific tape drive within the cabinet.
	Pwr off	This option shuts down a specific tape drive within the cabinet in preparation for tape drive removal.
	Reset	This option re initializes a specific tape drive within the cabinet.
	Drive Type	Displays the tape drive type (DLT or LTO)
	Serial Number	Displays the tape drive serial number.
	Firmware Revision	Displays the tape drive firmware revision.

- 2 When you are finished viewing tape drive information, press **Exit** to return to the **Ops** screen.

Scan Inventory

To perform an inventory of the library:

- 1 From the **Ops** screen, use the up and down arrows to highlight **Scan Inventory** and press **Enter**.

The **Success** screen displays. Press **Done** to complete.

Setup Screen

The **Setup** screen allows the user to view or edit various library settings such as date and time, network and host bus information.

To access the **Setup** screen, press **Setup** from the **Home** screen. The OCP displays the **Setup** screen (see [figure 30](#)):

Figure 35 Setup Screen



The **Setup** screen provides the following choices:

- [Cabinet Setup](#)
- [Partitions Setup](#)
- [Security](#)
- [Network](#)
- [Date and Time](#)

Cabinet Setup

To view the cabinet setup screen:

- 1 From the **Setup** screen, use the up and down arrows to highlight **Cabinet Setup** and press **Enter**.

The **Cabinet Setup** screen displays (see [figure 36](#)):

Figure 36 Cabinet Setup Screen

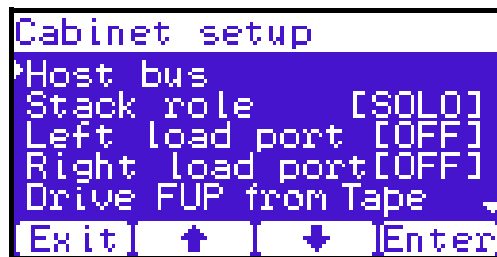

The **Cabinet Setup** screen displays the following options (see [table 13](#)):

Table 13 Cabinet Setup

Cabinet Setup	Description
Host bus	<p>Select the host bus option to view or edit the SCSI IDs for the changer (library) and tape drives. The Host bus option also allows you to set the Fibre Channel settings for any Fibre Channel tape drives installed. Loop ID, topology, and speed for each tape drive can be set.</p> <p>NOTE: SAS tape drives do not require a SCSI ID and cannot be configured. Use the default tape drive configuration information.</p>
Stack role	<p>Select the stack role option to view or set the library stack role (stand alone, master, or slave).</p>
Left load port	<p>Select the left load port options to enable/disable the left load port and also to designate one column or the entire magazine as a load port.</p>
Right load port	<p>Select the right load port options to enable/disable the right load port and also to designate one column or the entire magazine as a load port.</p>
Drive FUP from tape	<p>Select the magazine or fixed that contains the firmware update cartridge (FUP) and then the specific tape drive to update. The library must be offline to update the tape drive firmware.</p>
Full Inventory	<p>When full inventory is on, the library will complete a full inventory of the tape cartridges whenever a door is opened. When full inventory is off and a load port is accessed, the library will only inventory the load port and not the entire library.</p>

- 2 When you are finished viewing the cabinet setup information, press **Exit** to return to the **Setup** screen.

Partitions Setup

To view or edit the partition information:

- 1 From the **Setup** screen, use the up and down arrows to highlight **Partitions** and press **Enter**.

The **Partitions Setup** screen displays (see [figure 37](#)):

Figure 37 Partitions Setup Screen

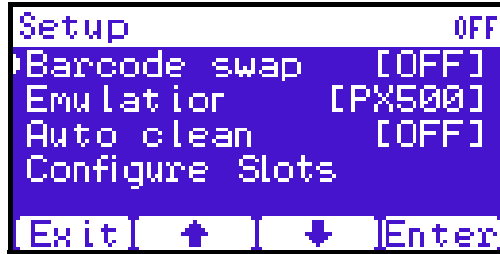

The **Partitions Setup** screen displays the following options (see [table 14](#)):

Table 14 Partitions Setup

Partitions Setup	Description
Barcode swap	Select the barcode swap to change the barcode swap option (enable/disable). When enabled, the media type prefix is swapped from the back of barcode to the beginning.
Emulation	Select the emulation option to change the library emulation mode. Emulation options are: Scalar 50, PX500, or P2000.
Auto clean	Select the auto clean option to change the library autoclean mode (enable/disable). When enabled, the library will automatically load a cleaning cartridge when a tape drive requests a cleaning.
Configure Slots	The configured slots option allows you to designate the number of slots available and reported to the host. Use the up and down arrows to highlight Configure Slots and press Enter . Enter the number of configured slots and press Enter . The library will reconfigure with the new slot count.

- 2 When you are finished viewing/editing the library setup information, press **Exit** to return to the **Setup** screen.

Security

To view or edit the security information:

- 1 From the **Setup** screen, use the up and down arrows to highlight **Security** and press **Enter**.

The **Security** screen displays (see [figure 38](#)):

Figure 38 Security Screen



The **Security** screen displays the following options (see [table 15](#)):

Table 15 Security Setup

Security Setup	Description
Set admin PIN	The admin PIN allows access to all areas of the OCP. Select Set admin PIN and use the up and down arrows to cycle through the PIN numbers. Press Enter to accept each digit and press Enter twice after the last digit of the PIN. You must verify the PIN number. The admin PIN can be 0 to 8 characters long, numbers only.

Security Setup	Description
Set operator PIN	The operator PIN only allows access to the Info or Ops menus of the OCP. The operator cannot change any library settings. Select Set operator PIN to set the operator PIN. use the up and down arrows to cycle through the PIN numbers. Press Enter to accept each digit and press Enter twice after the last digit of the PIN. You must verify the PIN number. The operator PIN can be 0 to 8 characters long, numbers only.

Note: OCP passwords are independent of the remote management passwords.

- 2 When you are finished viewing/editing the security setup information, press **Exit** to return to the **Setup** screen.

Network

To view or edit the network information:

- 1 From the **Setup** screen, use the up and down arrows to highlight **Network** and press **Enter**.

The **Network** screen displays (see [figure 39](#)):

Figure 39 Network Screen



The **Network** screen allows you to view or edit the following network settings:

Note: The network settings (IP address, subnet mask, and default gateway) are only active when DHCP is disabled.

- DHCP (default setting)
 - IP address
 - Subnet mask
 - Default gateway
 - Ethernet 0
- 2 Use the up and down arrows to select the network setting you wish to view or edit and press **Enter**.
 - a To enable/disable DHCP, press **Yes** to enable DHCP or **No** to disable DHCP. If your library is not connected to a network which uses a DHCP server to assign IP information, disable this function.
 - b To set the IP address, subnet mask, and gateway, use the up and down arrows to select the appropriate number and press **Enter** to accept.

Note: For the network information such as the IP address to be active, the library must reboot. To reboot the library, see [“Reboot Library”](#) on page 126.

- 3 When you are finished viewing/editing the network information, press **Exit** to return to the **Setup** screen.

Date and Time

To view or edit the date and time information:

- 1 From the **Setup** screen, use the up and down arrows to highlight **Date and Time** and press **Enter**.

The **Date and Time** screen displays (see [figure 40](#)):

Figure 40 Date and Time Screen



- 2 Use the up and down arrows to view or edit the date and time information. Press **Enter** to advance to the next choice. After you have edited the final setting (seconds), press **Save** to accept the new settings.
- 3 When you are finished viewing/editing the date and time information, press **Exit** to return to the **Setup** screen.

Diags Screen

The **Diagnostics** screen allows the user to perform diagnostic tests on the library.

To access the **Diagnostics** screen, press **Diags** from the **Home** screen. The OCP displays the **Diagnostics** screen (see [figure 41](#)):

Figure 41 Diagnostic Screen



Enter

The **Diagnostics** screen provides the following choices:

- [System-level Tests](#)
- [Component Tests](#)
- [Subsystem Tests](#)

System-level Tests

To execute a system-level test:

- 1 From the **Diags** screen, use the up and down arrows to highlight **System-level Test** and press **Enter**.

The **System-level Test** screen displays (see [figure 42](#)):

Figure 42 System-level Test Screen

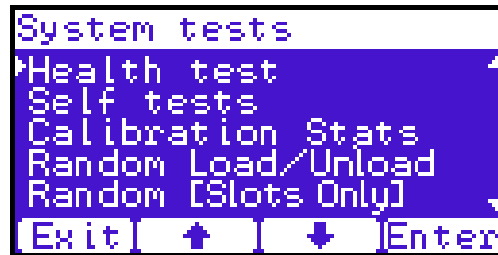

The **System-level Test** screen provides the following diagnostic tests:

- Health test
 - Self tests
 - Calibration stats
 - Random Load/Unload
 - Random (Slots Only)
 - Random (Drive Focus)
 - Sequential bins
 - Sequential drives
- 2 Use the up and down arrows to select the system test and press **Enter** to execute.
 - 3 When you are finished executing system-level tests, press **Exit** to return to the **Diags** screen.

Subsystem Tests

To execute a subsystem test:

- 1 From the **Diags** screen, use the up and down arrows to highlight **Subsystem Tests** and press **Enter**.

The **Subsystem Tests** screen displays (see [figure 43](#)):

Figure 43 Subsystem Tests
Screen

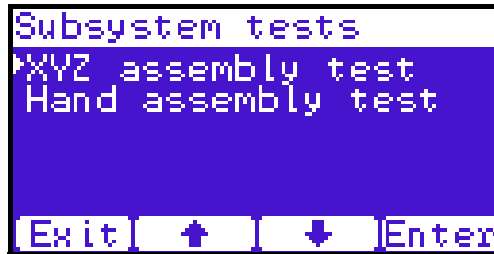

The **Subsystem Tests** screen provides the following diagnostic tests:

- XYZ assembly test
 - Hand assembly test
- 2 Use the up and down arrows to select the subsystem test and press **Enter** to execute.
 - 3 When you are finished executing subsystem tests, press **Exit** to return to the **Diags** screen.

Component Tests

To execute a component test:

- 1 From the **Diags** screen, use the up and down arrows to highlight **Component Tests** and press **Enter**.

The **Component Tests** screen displays (see [figure 44](#)):

Figure 44 Component Tests
Screen

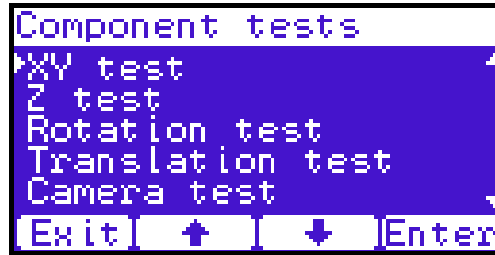

The **Component** test screen provides the following diagnostic tests:

- XY test
 - Y tests
 - Rotation stats
 - Translation test
 - Camera test
 - Temperature test
 - Home position
- 2 Use the up and down arrows to select the component test and press **Enter** to execute.
 - 3 When you are finished executing component tests, press **Exit** to return to the **Diags** screen.

Load Port Configuration

Load ports are used to import or export tape cartridges from the library. When configured as a load port, your backup application will automatically use these bins when exporting or importing tape cartridges. The bottom left and right magazines in each library can be configured to provide the following load port elements:

Caution: When placing tape cartridges in the load port slots, ensure that the tape cartridges are completely in the slot before sliding the magazine back into the library.

- Single column load port (5 slots SDLT/6 slots LTO)
- Magazine load port (15 slots SDLT/18 Slots LTO)

Tech Tip: Deciding between a single column and an entire magazine as a load port depends on the amount of tape cartridges you typically import/export from the library. If you generally import or export small numbers of tape cartridges to and from the library, a single column should be sufficient. If you import or export large numbers of tape cartridges, an entire magazine as a load port would be beneficial.

Each of the load ports are configured independently so that one load port can be configured as a column and the other load port can be configured as a column or as a magazine.

When set for a single column load port, the magazine is physically restricted to allow access to the first column in the magazine only.

When set for a 15-slot load port, the entire magazine can be removed (the same for a 18-slot LTO magazine).

The load port option is set using the operator control panel **Setup** menu. The settings are listed in [table 16](#) and illustrated in [figure 45](#).

Table 16 Import/Export Option Settings

Setting	Manual Access	SCSI Element
None	None	Storage element
Single column	Single column	Import/Export element
Magazine	Entire magazine	Import/Export element

Figure 45 Load Port Settings

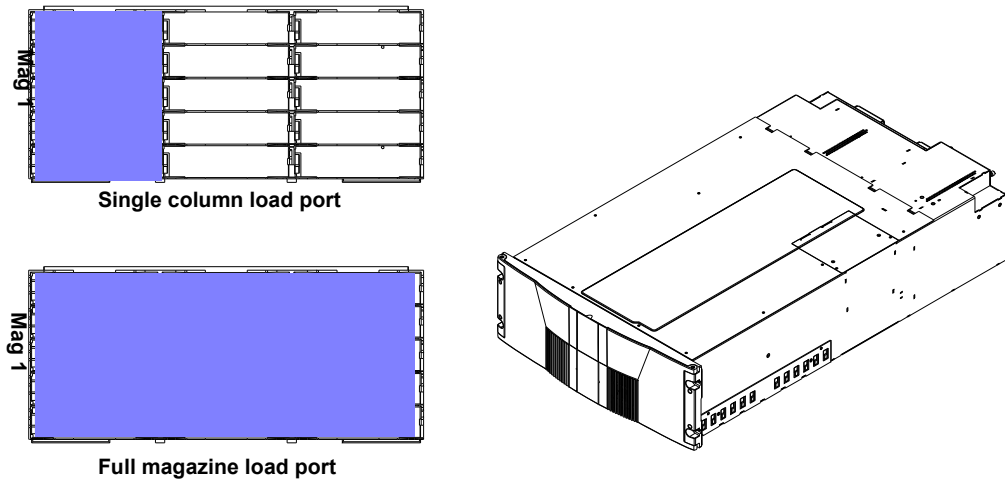

Enabling load ports will reduce the number of storage elements in the library. For example, if the library is set to the default capacity (left magazine only) and a single column is set aside as a load port, the storage capacity is reduced by the number of slots in that first column. The number of storage slots would be reduced by five for an SDLT magazine and six slots in a LTO magazine.

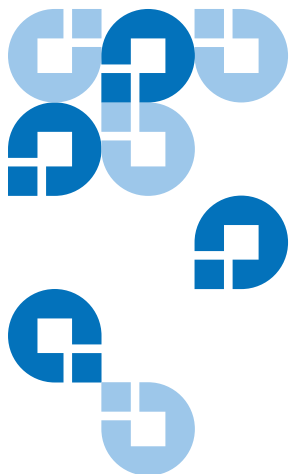

Quantum Scalar 50 Remote Management

The Quantum Scalar 50 library utilizes a web-based interface which allows you to configure and manage the library from a remote workstation on the same network. The Quantum Scalar 50 library is managed through the following web pages (accessible using Internet browser software installed on the host computer):

- [Status](#) allows you to view the following: hardware status, event logs, and statistics
- [Operations](#) allows you to perform cabinet operations remotely such as cartridge movement and inventory requests and drive operations
- [Setup](#) allows you to setup cabinet identification, user information, SCSI IDs, network information, events, date and time information, partitioning, secure tape, and tape encryption information.
- [Utilities](#) allows the user to run cabinet utilities remotely.
- [Reference](#) links to related sites.
- [Logout](#) allows the user to log out of the library remote management pages.

Quantum Scalar 50 Web Pages

The internet browser software is not supplied with the Quantum Scalar 50 library; you must obtain and install it independently. The Quantum Scalar 50 library supports the following internet browsers:

- Microsoft Internet Explorer 6.1 or later
You can download this software from <http://www.microsoft.com>.

Note: To optimize performance, all browsers should have both cookies and pop-ups enabled. This allows the refresh activities of the remote management web pages to work appropriately. Java 1.4.2 or above available from <http://www.java.com> should also be installed to support applets that automatically refresh pages and display pop-ups for warnings and critical events.

- Mozilla Suite 1.7 on Solaris 10
You can download this software from <http://www.mozilla.org>
- Firefox 1.0.6 on Windows
You can download this software from <http://www.mozilla.org>
- Java Plug-in 1.4.2 or later
You can download this software from <http://www.java.com>

Quantum Scalar Web Page Menu Items

The following figures depict the menu items available from the Quantum Scalar 50 Web Pages:

- [Figure 46](#) provides the default menus for the Scalar 50 web pages
- [Figure 47](#) provides an additional menu for the tape security feature available with the DLT-S4 tape drives. When this feature is enabled, the menu will display as part of the **Setup** page.

Figure 46 Quantum Scalar 50
Web Page Menu Items

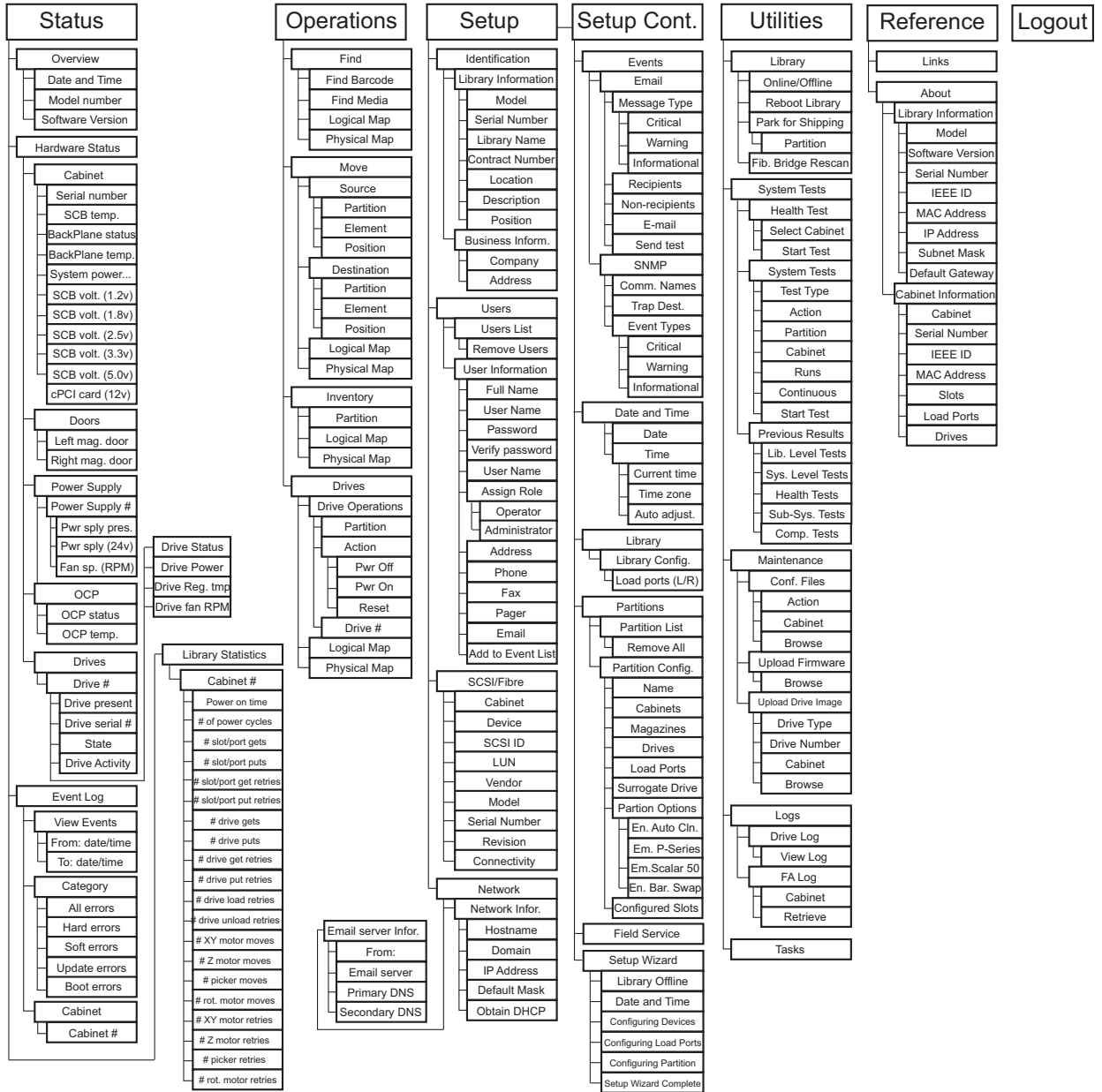
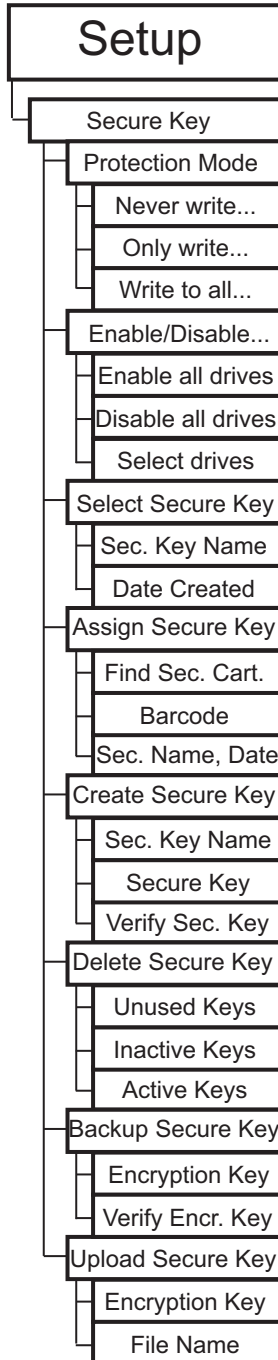

Figure 47 Quantum Tape
Security and Tape Encryption
Menus



Accessing Scalar 50 Web Pages

To access the Quantum Scalar 50 web pages:

- 1 On the host computer, open the internet browser software.
- 2 In the **Address** field, type `http://IPaddress/` where IP address is the IP address for the Quantum Scalar 50. (see [“Setup”](#) on page 84).
- 3 Enter the username and password and click **OK**.

Note: The default username and password is **admin**.

The **Overview** page displays (see [figure 48](#)):

Figure 48 Overview Page

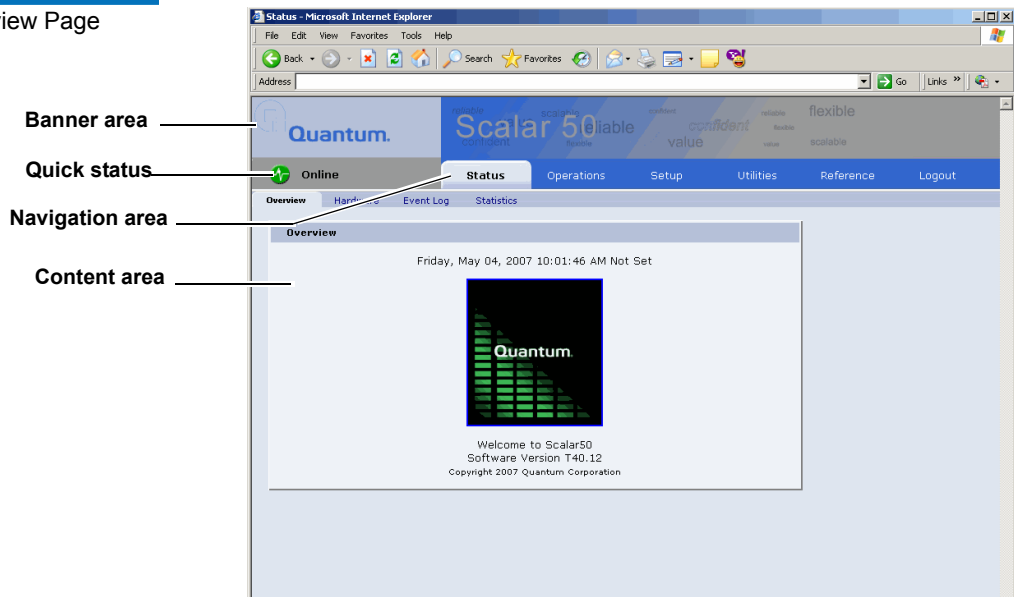

Using the Quantum Scalar 50 Web Pages

The first page that displays when you access the Quantum Scalar 50 web pages is the Quantum Scalar 50 **Overview** page (see [figure 48](#)). This page includes information on the Quantum Scalar 50 such as library name, date and time, and includes a dynamic graphic which changes colors depending on the library health.

The **Overview** page is divided into five distinct sections:

- Banner
- Quick status
- Navigation area
- Content area

The banner frame displays the corporate logo and product name. The contents frame displays a list of the Quantum Scalar 50 web pages. To view a page, click its corresponding link. The management frame displays the page you selected.

To return to a previous web page, click the browser's **Back** button.

Quick Status

The **Quick Status** icon provides the current health status for the library. Refer to the following tables ([table 17](#) and [table 18](#)) for quick status library health conditions.

Table 17 Quick Status Library Health Conditions



Quick Status Icon	Library Health	Description
 Online	Library health: OK .	The library health is OK .
 Online	Library health: Critical	The library health is in a Critical state (needs attention)

Table 18 Quick Status Health Messages

Quick Status Messages	Description
Online and Offline	These messages indicate the current availability status of the library.
Init Error	The library has failed to initialize. Review the hardware status page and contact Quantum Customer Support if necessary.

Quick Status Messages	Description
Stopped	The hand has stopped. Check the error log and contact Quantum Customer Support if necessary.
Door Open	A library door is open.
Tape Cleaning	A tape drive is being cleaned.
Moving	A tape cartridge is being moved.
Code Update	The library is in the process of upgrading the system code. Wait until the process is complete
Initializing	The library is in the process of coming online. Wait until the library becomes online.
Power Down	The library is powering down. Wait for the unit to shutdown.
Communication Down	The library is in the process of shutting down. Library communication will resume when the library powers on.
Over Temp	The library has exceeded the maximum temperature threshold. Review the hardware status page and contact Quantum Customer Support if necessary.
Diagnostic	The library is executing a diagnostic test. Wait for the test to complete.

Status

The **Status** page displays the general status or health of the library as well as specific hardware status. The page also provides access to event logs as well as library statistics.

The **Status** page is divided into the following sections:

- [Overview Page](#)
- [Hardware Status Page](#)
- [Event Log Page](#)
- [Statistics Page](#)

Overview Page

To access the **Overview** page, from any page, click **Status** from the navigation bar.

The management frame displays the **Status** page (see [figure 49](#)).

Figure 49 Status Page

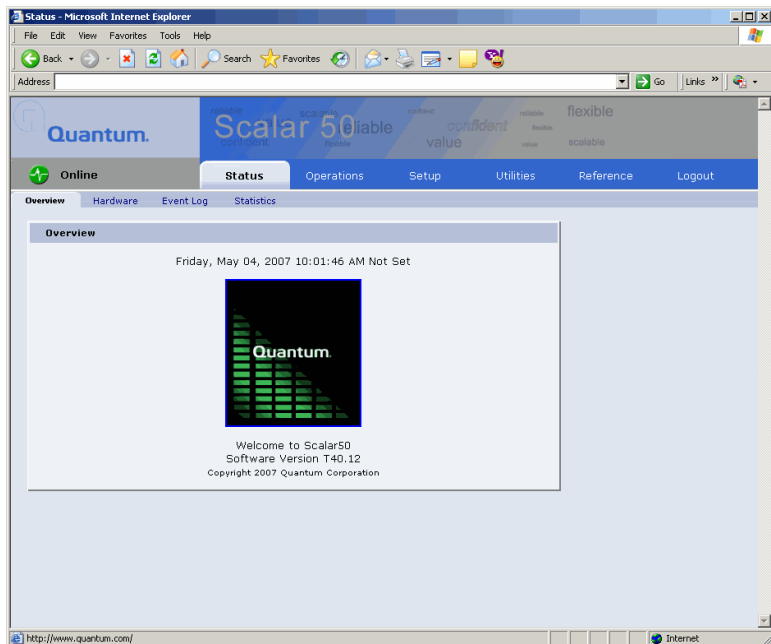

Hardware Status Page

The **Hardware** status page displays the library component status within the library.

To access the **Hardware** page, from the **Status** page, click on the **Hardware** tab at the top of the page.

The **Hardware Status** page displays (see [figure 50](#)):

Figure 50 Hardware Status Page

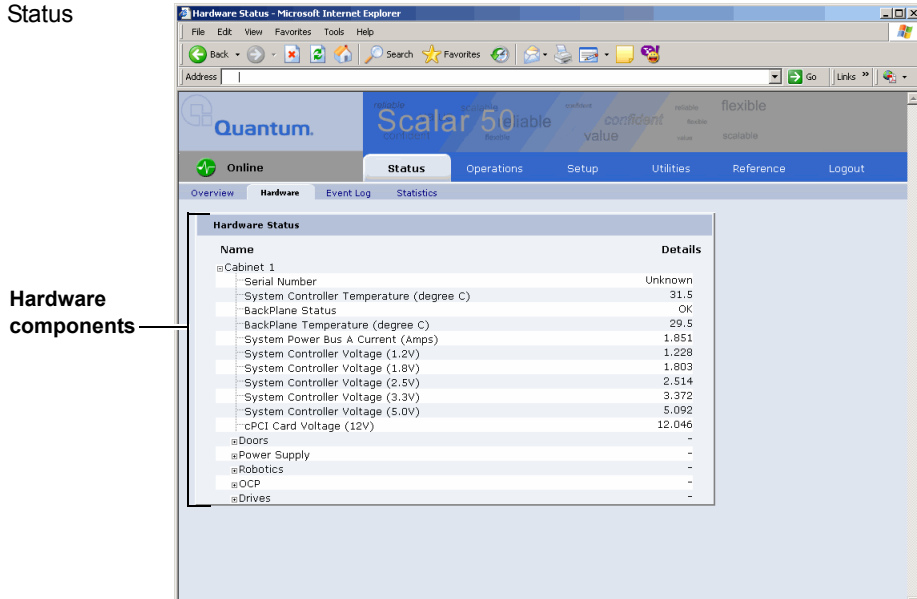

Library components within the library are displayed in a tree-like fashion. A red background indicates critical or failed condition. Related values or error messages are listed under details.

To view the status of a library component

- 1 Click on a plus sign to expand a branch and display the status of related subcomponents. Click on a minus sign to collapse a branch. Click **Expand All/Collapse All** to expand or collapse all branches.

Some components, such as drives, are displayed as a link. Clicking on the link will open a detail window displaying all data related to the component.

Event Log Page

The **Event Log** page allows the user to view events that occur on the library. These events are divided into the following categories:

- All - views all events in all categories
- Hard - views only hardware related events
- Soft - views only software related events
- Update - views only events related to library update functions
- Boot - views only events related to library boot sequence

To access the **Event Log** page, from the **Status** page, click on the **Event Log** tab at the top of the page.

The **Event Log** page displays (see [figure 51](#)):

Figure 51 Event Log Page

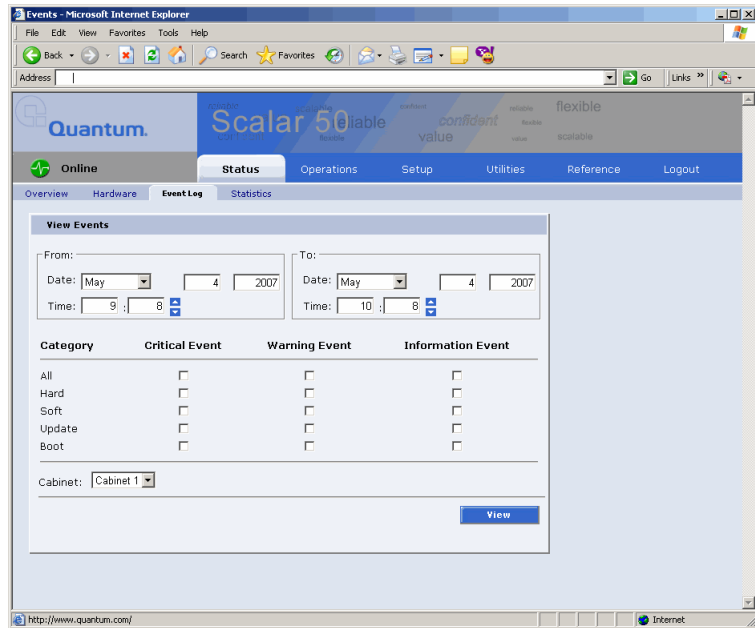

To view an **Event Log**:

- 1 In the **Event Log** page, change the **From** and **To** areas to reflect the time range of the event log you wish to view. Click the up and down arrows to change the hour and/or minute values by increments of one. Double-clicking will increment or decrement the value by 5. You may also type in a valid hour (0 - 24) or minute (0 - 59).

Note: The default date/time range is one hour prior to the current time and day.

- 2 Select desired categories and priority levels (critical, warning, or informational) for the event list.
- 3 Click **View** to display the list.

Note: Search time will vary depending on the time range entered.

A smaller window displays the information matching the range, category, and priority specified.

Statistics Page

The **Statistics** page allows the user to view library statistics for the entire library or certain components within the library.

The following table shows the statistics available from the **Statistics** page:

Table 19 Statistics Information

Cabinet or Component	Statistical Information
Cabinet (library)	Time since last power-on (seconds)
	Time processing robot commands (seconds)
	Estimated number of power cycles
	Attempted slot/port picks
	Attempted slot/port places
	Attempted drive picks
	Attempted drive places
	Number of individual horizontal moves
	Number of individual vertical moves
	Number of individual extension moves
	Number of individual hand moves
	Number of individual depth moves
	Number of individual rotary moves
	Number of horizontal retries
Number of vertical retries	

Cabinet or Component	Statistical Information
	Number of extension retries
	Number of hand retries
	Number of depth retries
	Number of rotary retries
	Number of drive place retries
	Number of drive pick retries
	Number of partially gripped cartridge retries
	Number of drive load retries
	Number of barcode scan retries
	Number of slot/port pick retries
	Number of slot/port place retries

To access the **Statistics** page, from the **Status** page, click on the **Statistics** tab at the top of the page.

The **Statistics** page displays (see [figure 52](#)):

Figure 52 Statistics Page

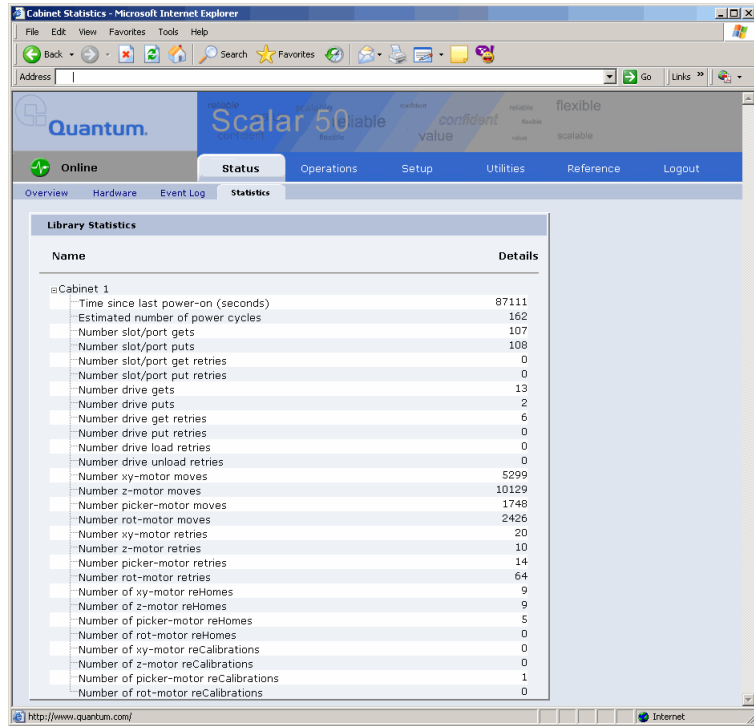

Note: Statistics for individual elements (a specific drive, slot, or port) are included in the element detail window and can be viewed by clicking on a drive, slot, or port link from zoom windows accessed via the **Operations** pages. The zoom windows are opened by clicking on the panel or cluster name from physical or logical maps.

Operations

The **Operations** page is divided into the following sections:

- [Find Page](#)
- [Move Page](#)
- [Inventory Page](#)
- [Drives Page](#)

Accessing the Operations Page

To access the **Operations** page, click **Operations** from the contents frame.

The management frame displays the **Operations** page (see [figure 53](#)).

Figure 53 Operations Page

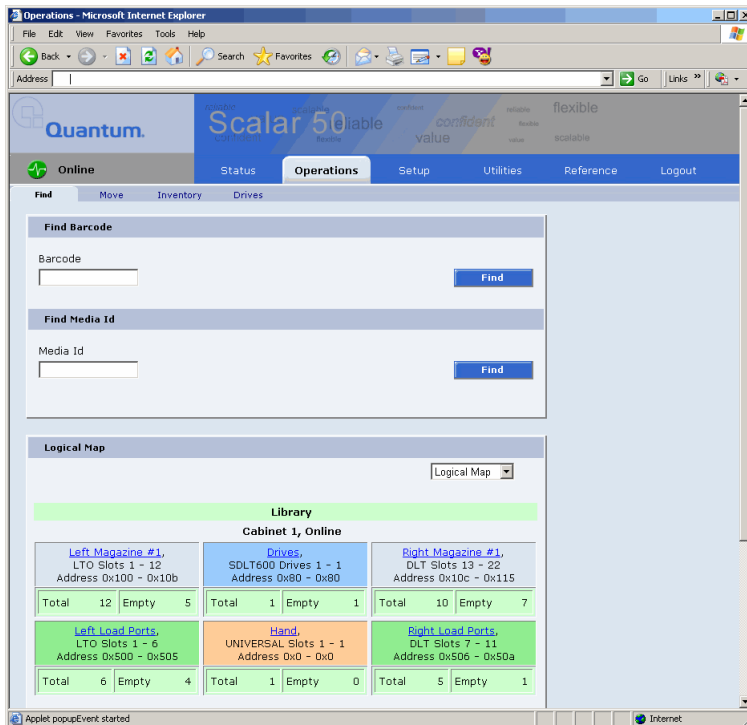

Find Page

The **Find** page allows the user to find and locate specific barcodes within the library as well as view the library contents (slots, ports, drives, hand, or address).

To access the **Find** page, from the **Operations** page, click on the **Find** tab at the top of the page.

The **Find** page displays (see [figure 54](#)):

Figure 54 Find Page

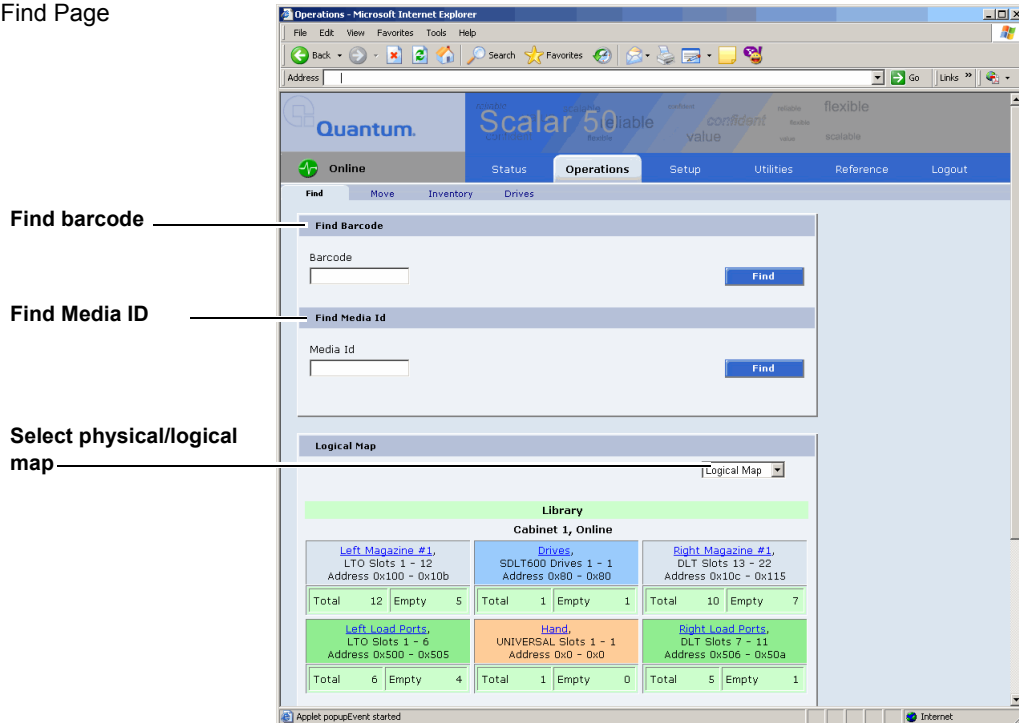

The **Find** page is divided into the following sections:

- [Find Barcode](#)
- [Find Media ID](#)
- [Select Map](#)

Find Barcode

The find barcode section allows the user to find a specific barcode (or partial barcode) within the library and view its location.

To find a barcode or partial barcode:

- 1 Enter a barcode, or partial barcode with wildcards (*,?) in the barcode field.

Note: Leaving the barcode field empty will result in listing all barcode labels within the library.

- 2 Click **Find**.

A separate window displays the barcode(s) sharing the barcode string entered in the barcode field. Click the individual barcode label to display the corresponding cartridge detail page.

Find Media ID

The show contents section allows the user to locate a specific media ID within the library (slots, ports, drives, hand, or address)

To find a media ID:

- 1 Enter a media ID, or partial ID with wildcards (*, ?) in the Media ID field.

Note: Leaving the media ID field empty will result in listing all barcode labels within the library.

- 2 Click **Find**.

A separate window displays the media ID(s) sharing the string entered in the media ID field. Click the individual barcode label to display the corresponding cartridge detail page.

Select Map

The select map section allows the user to view the library in either a physical or logical view. To toggle between physical and logical map, click the **Physical/Logical Map** button in the map section.

Note: The **Physical/Logical Map** information is displayed at the bottom of each **Operations** page.

Physical Map: A physical view displays a high level physical representation of the library. Slots, magazines, drives, and fixed slots are displayed as a panel located on either the left, rear, or right wall of the library. Clicking on the panel name opens a zoom view of the panel (i.e. similar to pulling out a loadport or drawer) displaying all elements (slots, ports, or drives) in a spreadsheet format.

Note: The physical map may show gaps in the element numbering depending on the load port configuration.

Logical Map: A logical map displays slots, magazines, drives, and fixed slots. Clicking on the panel name opens a zoom view of the panel (i.e. similar to pulling out a loadport or drawer) displaying all elements (slots, ports, or drives) in a spreadsheet format. From the zoom view, clicking on an element opens a detail window.

Note: Under the **Logical Map** view, an option to print the view to a local printer is available by clicking on the **Print View** link located in the upper left-hand corner of the **Logical Map** section.

Move Page

The **Move** page allows the user to move a single cartridge from a source (slot, port, drive, or address) to a destination (slot, port, drive, or address).

Note: The library must be off-line to move a cartridge.

To access the **Move** page, from the **Operations** page, click on the **Move** tab at the top of the page.

The **Move** page displays (see [figure 55](#)):

Figure 55 Move Page

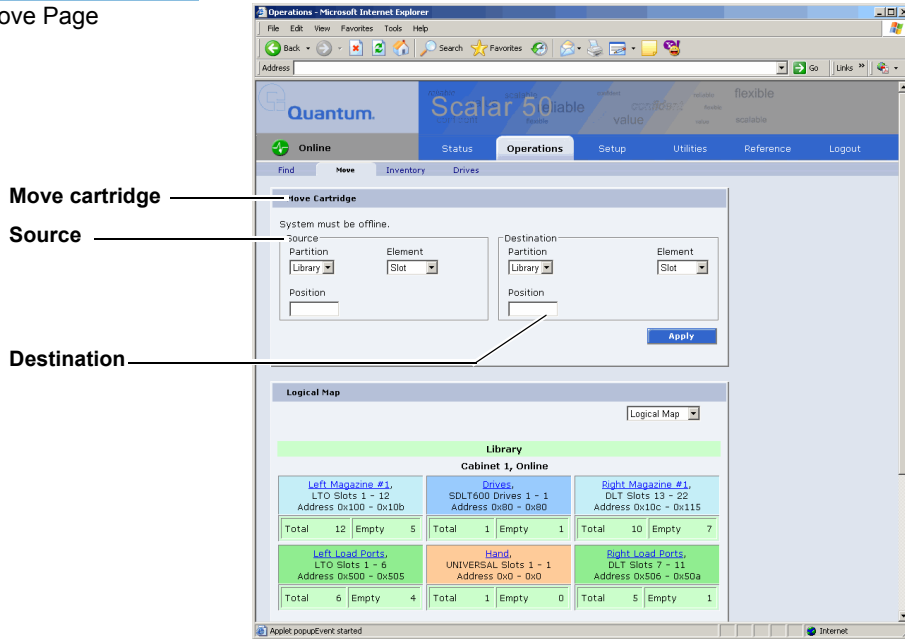

To move a cartridge:

- 1 Select a cabinet, source element (slot, drive, address, or hand), and enter a starting position and count. If the count field is left empty, only the starting cartridge is moved.

Note: The hand is the robotic gripper used to move cartridges in the library. If the library is in a stacked environment with other Scalar 50 libraries, the pass-thru slot is available as a source element.

- 2 Select a destination cabinet, element, and position. If more than one cartridge is moved, the position entered in as a destination is the first one filled, consecutive elements must be empty.

Inventory Page

The **Inventory** page allows the user to perform an inventory on all elements within the library or specific element ranges.

Note: The library must be off-line to perform an inventory.

To access the **Inventory** page, from the **Operations** page, click on the **Inventory** tab at the top of the page.

The **Inventory** page displays (see [figure 56](#)):

Figure 56 Inventory Page

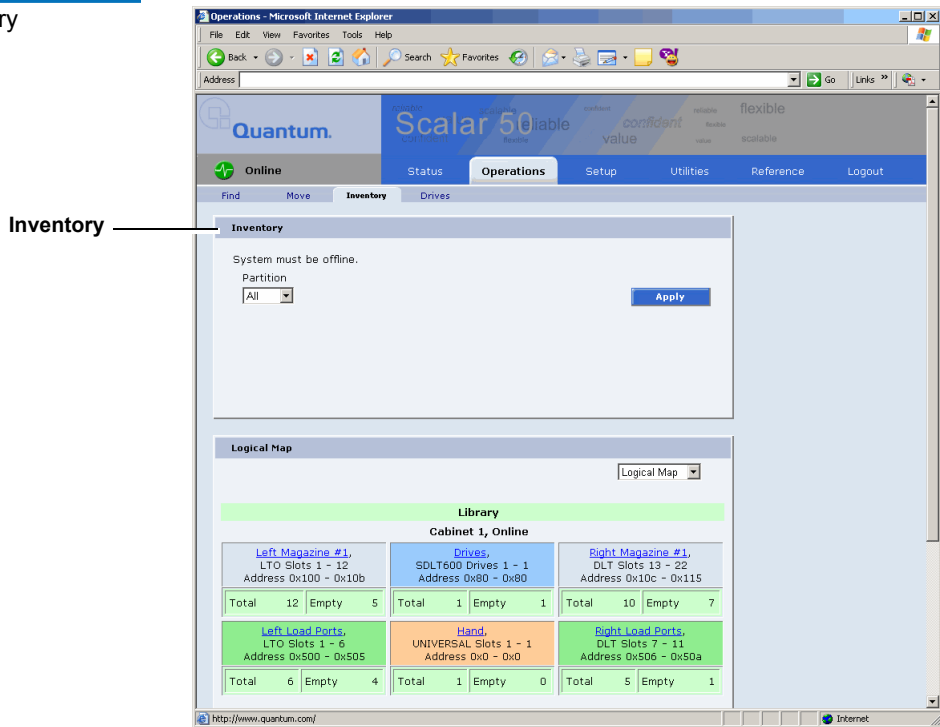

To perform an inventory:

- 1 Select the cabinet or library to inventory.
- 2 Click **Apply** to perform the inventory.

The progress of the inventory displays in a separate window.

Drives Page

The **Drives** page allows the user to perform the following actions on the tape drives within the library:

- Reset - re initializes the tape drive
- Power off - shuts down the tape drive
- Power on - powers on the tape drive

To access the **Drives** page, from the **Operations** page, click on the **Drives** tab at the top of the page.

The **Drives** page displays (see [figure 57](#)):

Figure 57 Drives Page

Drive operations

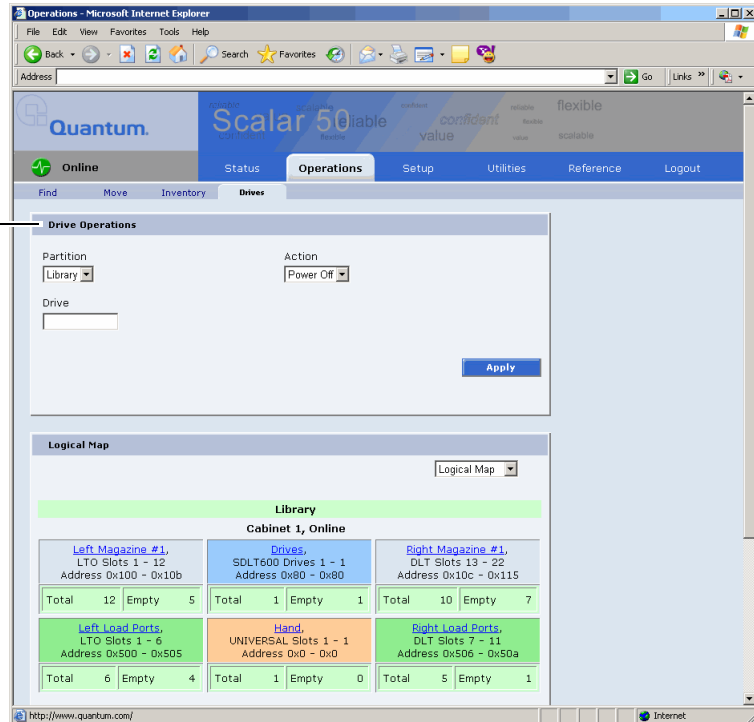

To perform an action on a tape drive(s)

- 1 Select a cabinet and enter a tape drive number
- 2 Select the action to perform (power off, power on, or reset).

Caution: Ensure that the tape drive does not contain a tape cartridge prior to powering down the tape drive.

Note: If you power a tape drive off from the **Drives** page and then power the tape drive back on, the tape drive must then be reset to be operational. The complete process from the **Drives** page is, power the tape drive off, power the tape drive on, reset the tape drive.

- 3 Click **Apply** to perform the action.
The drive actions are performed.

Setup

The **Setup** page is divided into the following sections:

- [Identification](#)
- [Users](#)
- [Key Users](#)
- [SCSI/Fibre](#)
- [iSCSI Bridge](#) - Only if a Fibre Channel or iSCSI bridge is present
- [Network](#)
- [Events](#)
- [Date & Time](#)
- [Library](#)
- [Partitions](#)
- [Field Service](#)

- [Setup Wizard](#)
- [Secure Key](#)

Note: The [Secure Key](#) tab is only available under the **Setup** page when the secure key administrator (**skadmin**) is logged onto the system **AND** a secure key capable tape drive (DLT-S4) is installed in the library.

- [Secure Key Best Practices and Tape Migration](#)

Accessing the Setup Page

To access the **Setup** page, click **Setup** from the contents frame. The management frame displays the **Setup** page (see [figure 58](#)).

Figure 58 Setup Page

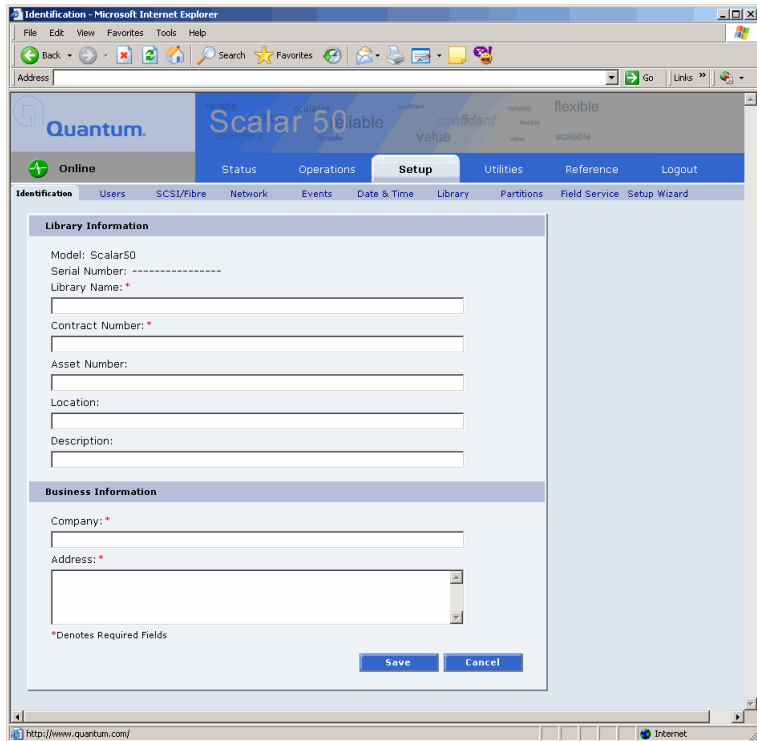

Identification

The identification information is used to identify the library to assist customer support when servicing the library.

- 1 To access the **Identification** page, from the **Setup** page, click on the **Identification** tab at the top of the page.

The **Identification** page displays (see [figure 58](#)).

- 2 Edit the identification information as desired (see [table 20](#) for a description of the fields).
- 3 Click **Save** when complete.

Table 20 Identification Information

Field	Description
Model	Display only. Not entered by user
Serial Number	Display only. Not entered by user
Library Name*	Enter a name to identify this specific library
Contract Number*	Enter the contract number for the library. This is used to identify the library to customer support.
Asset Number	Customer internal tracking number.
Location	Enter the location of the library. This helps to identify the library when remotely controlling multiple machines.
Description	Enter a short description of the library.
Company*	Enter the company name where the library is located
Address*	Enter the company address where the library is located
*	Indicates a required field.

Users

This section allows users to be added to the library configuration. The user access is also controlled from this section as well as email notification.

- 1 To access the **Users** page, from the **Setup** page, click on the **Users** tab at the top of the page.

The **Users** page displays (see [figure 59](#)).

Figure 59 Users Page

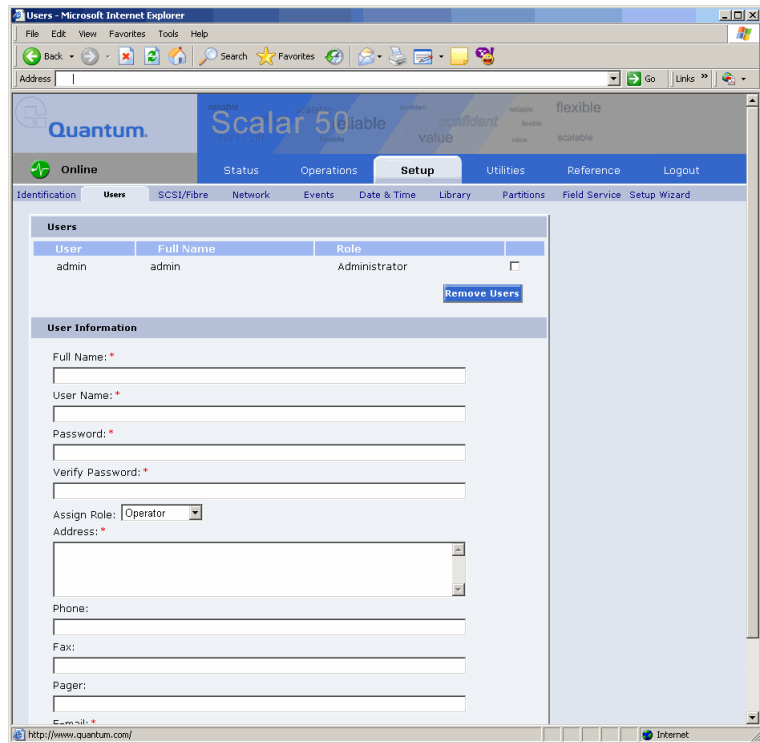

- 2 Edit the user information as desired (see [table 21](#) for a description of the fields).

Note: The username and password are limited to 7 characters.

- 3 Click **Apply** when complete.
- 4 To remove a user, select the user check box and click **Remove User**.

Table 21 User Information

Field	Description
Full Name*	Enter the full name of the user
User Name*	Enter a user name. The user name can be no more than seven characters.
Password/Verify Password*	Enter a password. The password can be no more than seven characters.
Assign Role	Select either Administrator or Operator for user privileges. An operator only has access to library status information. An administrator has access to all areas of the remote management pages.
Address*	Enter an address for the user's location
Phone	Enter the users phone number
Fax	Enter the users fax number
Pager	Enter the users pager number
E-mail*	Enter the users email address
Add to Events E-mail List	Adds this user to the email events list.
*	Indicates a required field.

Key Users

The **Key User** is the only user that has the ability to create, modify, and delete a **Secure Key** for the library. The **Key User** also has the ability to enable and disable **Secure Capable Drives** for reading and writing data to and from tapes using the **Secure Keys**.

Creating a Key User

When a user is created with administrator privileges (other than the default admin user), the **Create Key User** section appears at the bottom of the **Users** page (see [figure 60](#)).

Figure 60 Create Key User

To create a **Key User**:

Note: Only users with administrator privileges (other than the default administrator) can create a secure user.

There is only one **Key User** and the username is always **skadmin**.

- 1 Enter a secure password.

Note: **Key User Passwords** must be at least four characters long and include at least one non-alphanumeric character. Spaces, double quotes (“), and blank passwords are rejected. **Key User Password** and **Verify Password** must match.

- 2 Verify the secure password by entering the password a second time in the **Verify Password** box.
- 3 Click **Create** to create the **Key User**.

The **Key User** is created.

Remove Key User

Once the **Key User** is added, the **Remove Secure User** section displays at the bottom of the **Users** page (see [figure 61](#)).

Figure 61 Remove Secure User

To remove the **Key User**, click **Remove**.

The **Key User** is removed.

Updating the Key User Password

To update the secure key password:

Note: Only the **Key User** (logged in as **skadmin**) can change the key user password.

- 1 Log on to the library as the **Key User** (username: **skadmin**).
- 2 Enter the current **Key User Password**.
- 3 Click the **Users** tab.

The **Change Key User Password** section displays at the bottom of the **Users** page (see [figure 62](#)).

Figure 62 Change Key User Password

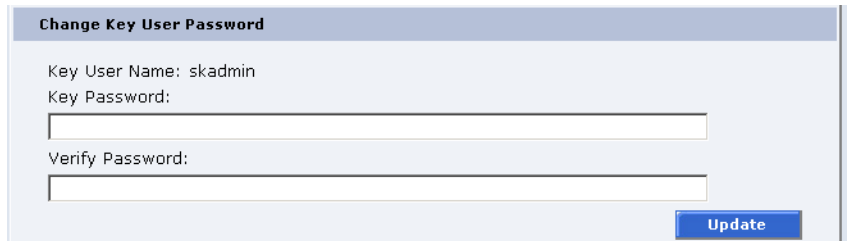

The screenshot shows a web form titled "Change Key User Password". The form contains the following elements: a label "Key User Name: skadmin", a label "Key Password:" followed by a text input field, a label "Verify Password:" followed by another text input field, and a blue "Update" button at the bottom right.

- 4 Enter a new **Key User Password**.

Note: **Key User Passwords** must be alphanumeric strings of at least one character. A blank secure password will be rejected. **Key User Password** and **Verify Password** must match.

- 5 Verify the **Key User Password** by entering the password a second time in the **Verify Password** box.
- 6 Click **Update** to update the **Key User Password**.

The **Key User Password** is updated.

SCSI/Fibre

This section allows the user to set the SCSI IDs for the changer (library) and every tape drive within the library and also configure any Fibre Channel tape drives.

Note: You can also determine the tape drive firmware revision from the **SCSI/Fibre** page.

Note: SAS tape drives do not require a SCSI ID and cannot be configured. Use the default tape drive configuration information.

- 1 To access the **SCSI/Fibre** page, from the **Setup** page, click on the **SCSI/Fibre** tab at the top of the page.

The **SCSI/Fibre** page displays (see [figure 63](#)).

Figure 63 SCSI Page

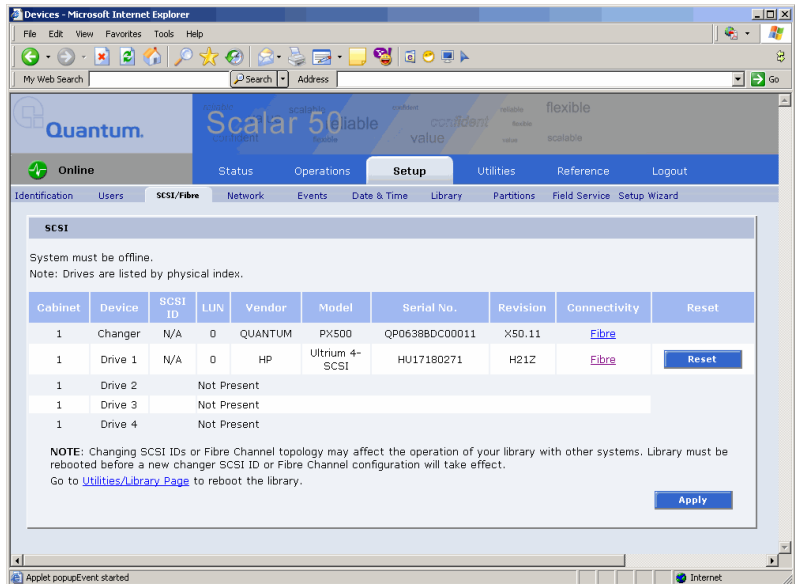

- 2 To change a SCSI ID, enter the ID number in the field next to the device and click **Apply**.

To change a drive SCSI ID, the cabinet must be off-line.

Note: Changing SCSI IDs or Fibre Channel topology may affect the operation of your library with other systems. Library must be rebooted before a new changer SCSI ID or Fibre Channel configuration will take effect.

- 3 Click the device (tape drives) to view the drive details.

Native Fibre Channel Tape Drives

To configure the Native Fibre channel topology, speed, and loop ID:

- 1 Click on the **Fibre** link under the **Connectivity** type.

The media changer or tape drive configuration screen displays. Refer to [table 22](#) for configuration options.

Table 22 Native Fibre Channel Configuration Options

Configuration Option	Description
Configured Speed	Select 1 G, 2 G, 4G, or Auto Negotiate to set the configured speed
Configured Topology	Select point-to-point, arbitrated loop, or Auto negotiate to set the configured topology.
Loop ID	Select the loop ID. The loop ID can only be set when the configured topology is set to arbitrated loop.

iSCSI Bridge

This section allows users manage the TC2201 iSCSI bridges installed in the cabinet.

Note: The iSCSI bridge information only displays when a iSCSI bridge is installed in the library.

- 1 To access the **iSCSI Bridge** page, from the **Setup** page, click on the **iSCSI Bridge** tab at the top of the page.

The **iSCSI Bridge** page displays (see [figure 64](#)).

Figure 64 iSCSI Page



The iSCSI bridge page displays:

- Cabinet number(s)
 - Device number(s)
 - IP address for the iSCSI bridge
 - Model of the iSCSI bridge
 - World wide name for the iSCSI bridge
 - Serial number for the iSCSI bridge
 - Current firmware revision on the iSCSI bridge
- 2 Click **Rescan** to discover new iSCSI bridges or updated firmware.
 - 3 Click on the iSCSI bridge you want to manage.

The TC2201 web interface displays. For more information on the TC2201 iSCSI bridge and the web interface, see the *Quantum TC2201 User's Guide* (PN 81-81539) included on the Quantum Scalar 50 documentation CD.

Network

The network information section allows the user to enter network information so the library can be controlled remotely via an Ethernet network.

- 1 To access the **Network** page, from the **Setup** page, click on the **Network** tab at the top of the page.

The **Network** page displays (see [figure 65](#)).

Figure 65 Network Page

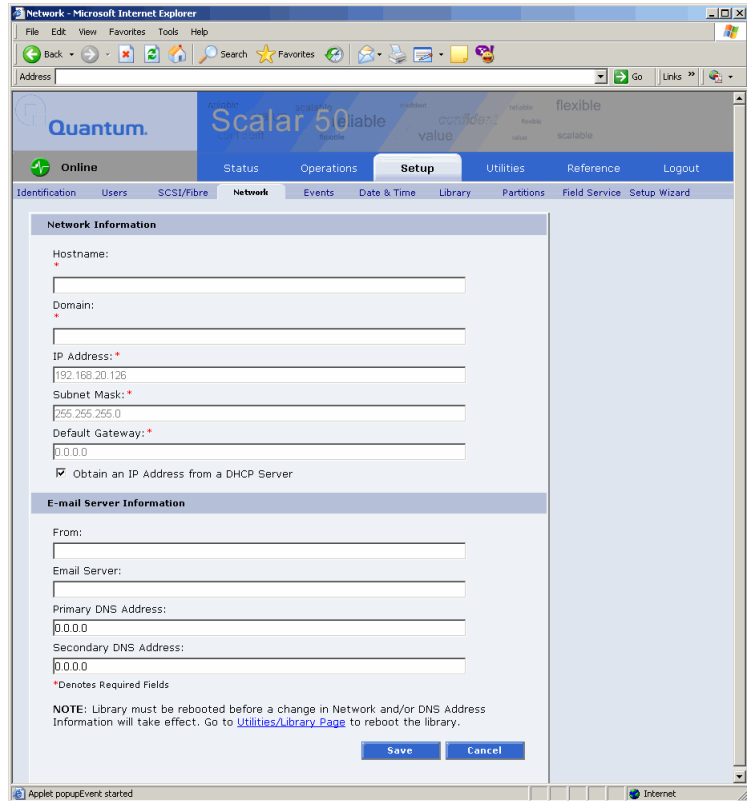

- 2 Edit the network information as desired (see [table 23](#) for a description of the fields).
- 3 Click **Save**.

The Quantum Scalar 50 will not use the new network information until it has been rebooted (see [“Setup” on page 84](#)).

Table 23 Network Configuration Fields

Field	Description
Hostname*	View or set the hostname for the library (for example, the DNS name)
Domain*	View or set the domain name for the library
IP Address*	View or set the IP address for the library
Subnet Mask*	View or set the subnet mask for the library
Default Gateway*	View or set the default gateway for the library
Obtain IP from DHCP Server	If your network uses a DHCP server to assign device IP addresses dynamically, select this box
Email Server	View or set the email server information
Primary DNS Address	View or set the primary DNS address
Secondary DNS Address	View or set the secondary DNS address
*	Indicates a required field.

Events

The **Events** page allows the user to designate what library events are emailed to users as well as setup SNMP traps.

Note: For a complete list of available library events, see [chapter 4](#) on page 137.

- 1 To access the **Events** page, from the **Setup** page, click on the **Events** tab at the top of the page.

The **Events** page displays (see [figure 66](#)).

Figure 66 Events Page

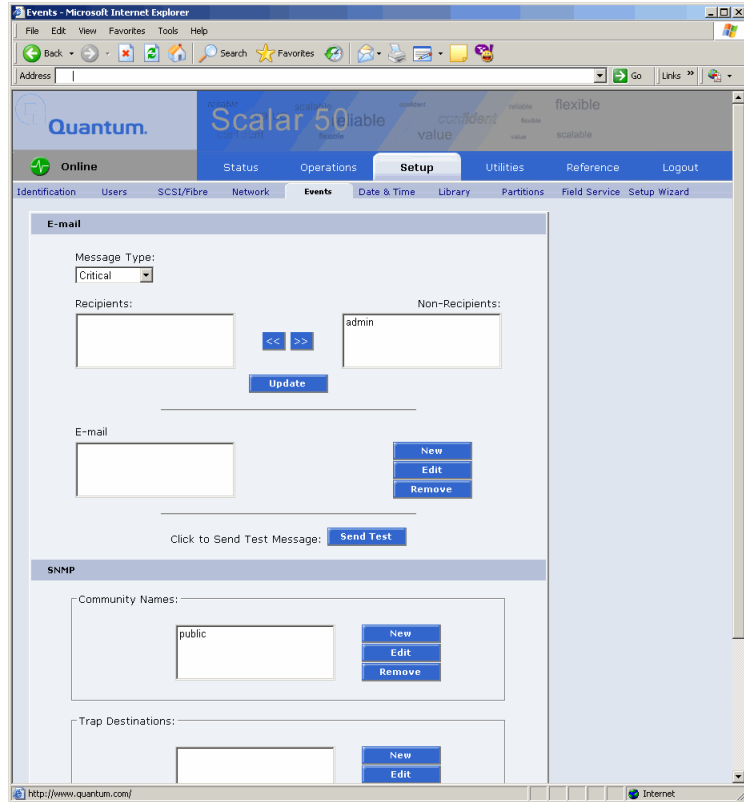

- 2 Edit the Email information as desired (see [table 24](#) for a description of the fields) and click **Update**.
- 3 After editing the Email information, click the **Send** button to test the notification system. If the test is not successful, verify the email server information and the administrative recipients list and try again.

The **Email** area details are shown in [table 24](#), [table 25](#), and [table 25](#).

Table 24 Email Notification

Field	Description
Message Type: Critical	When a hardware failure occurs on the Quantum Scalar 50 system such as a transition to a degraded, limited access, or failed system state, an email is sent to everyone on the critical failure recipient list.
Message Type: Warning	When a warning state exists on the Quantum Scalar 50 system such as an overtemp condition, an email is sent to everyone on the warning recipient list.
Message Type: Informational	When an informational event has occurred on the Quantum Scalar 50 system such as starting up or shutting down the system, an email is sent to everyone on the operator access recipient list.
New	To add a new recipient to a specific list, type the email address of the new recipient in the field and click Save .
Edit	To edit a recipient, select the individual email address from the list and click Edit .
Remove	To remove an email notification type from the E-mail list, select the E-mail type and click Remove .

Table 25 Send Email Test

Field	Description
Send Test	To test the email notification system, click Send Test . An email is sent to the critical e-mail recipients list. If the test email is not successful, verify the email server information and the critical recipients list and try again.

SNMP

If the customer wishes to use the Quantum Scalar 50 system with a network framework application such as HP OpenView, or CA Unicenter, the SNMP configuration must be defined. SNMP stands for Simple Network Management Protocol, a set of protocols for managing complex networks. SNMP works by sending messages, called protocol data units (PDUs), to different parts of a network. SNMP-compliant devices, called agents, store data about themselves in Management Information Bases (MIBs) and return this data to the SNMP requesters.

- 1 Under **Community Names** (see [figure 67](#)), click **New** to enter the new community information:
 - a A unique name in the **Name** field, the field holds up to 60 characters. No blank spaces are allowed.
 - b IP address in the **IP Address** field, if the value in the Network Mask edit box ends in a zero, the value in the IP address edit box must also end in a zero
 - c Subnet mask in the **Network Mask** field.
 - d Access rights for the new community:
 - **Read Only** allows SNMP **read** operations:
 - **Read/Write** allows both SNMP **read** and **write** operations.
- 2 Click **Save**.

A **Results** page displays indicating the community has been added.
- 3 Click **New** in the Trap Destination area (see [figure 67](#)), to set the IP addresses that are to receive the traps generated by the Quantum Scalar 50, for example, 12.34.56.78.

Figure 67 SNMP Section of Event Page

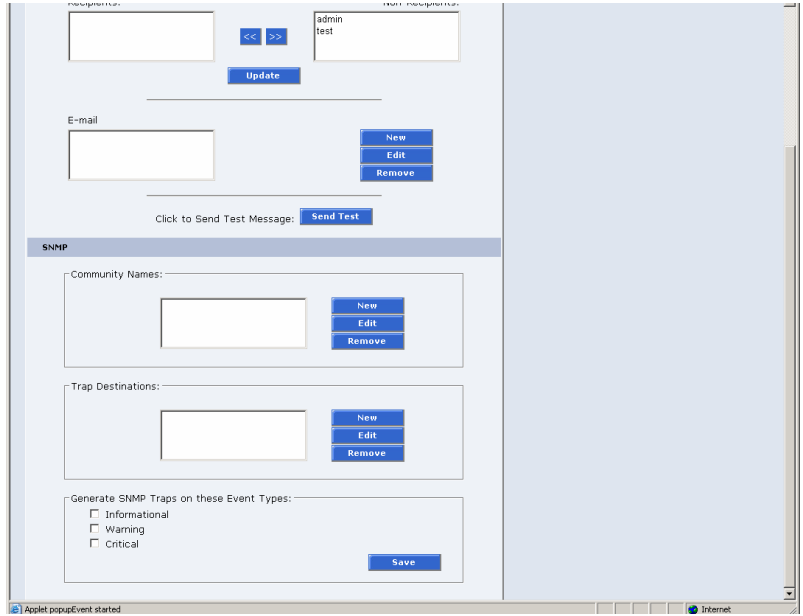

4 Enable the trap selections to be reported (see [table 26](#)):

Table 26 SNMP Trap Selections

Field	Description
Informational	If selected, Informational Traps are enabled.
Warning	If selected, Warning Traps are enabled.
Critical	If selected, Critical Traps are enabled.

5 Click **Save**.

A **Results** page displays indicating the configuration has been changed.

Date & Time

The date and time page allows the user to view and set the date and time on the library. This allows the library to time stamp any events that occur.

Note: The Quantum Scalar 50 must be offline to adjust the time and date.

- 1 To access the **Date & Time** page, from the **Setup** page, click on the **Date & Time** tab at the top of the page.

The **Date & Time** page displays (see [figure 68](#)).

Figure 68 Date & Time Page

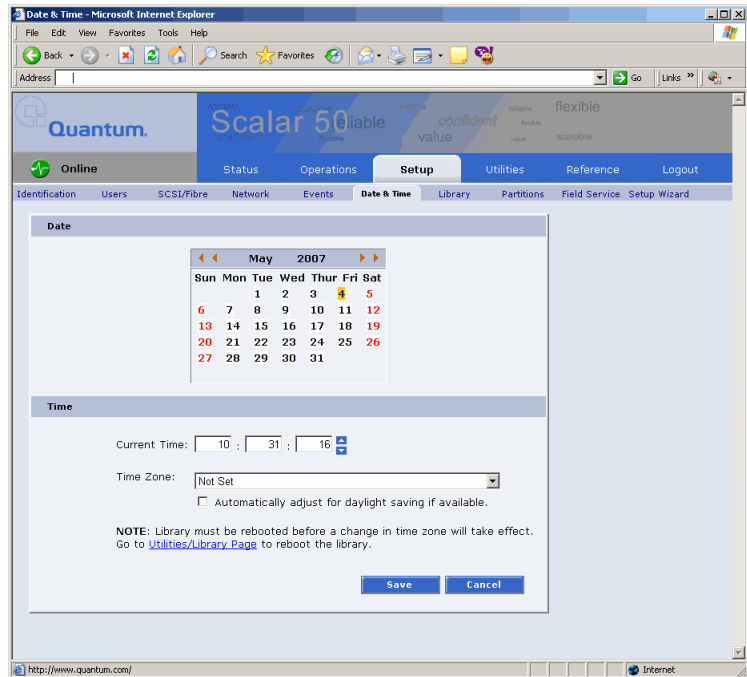

- 2 Select **Manual** to manually set the system date and time using the **Change** button for the system date and drop down boxes for the system time.
- 3 Click **Save** when complete.

The Quantum Scalar 50 will not use the new date and time zone information until it has been rebooted.

Library

The library configuration section allows the user to configure automatic library settings.

Note: The library must be offline to change the library settings.

- 1 To access the **Library** page, from the **Setup** page, click on the **Library** tab at the top of the page.

The **Library** page displays (see [figure 69](#)).

Figure 69 Library Page

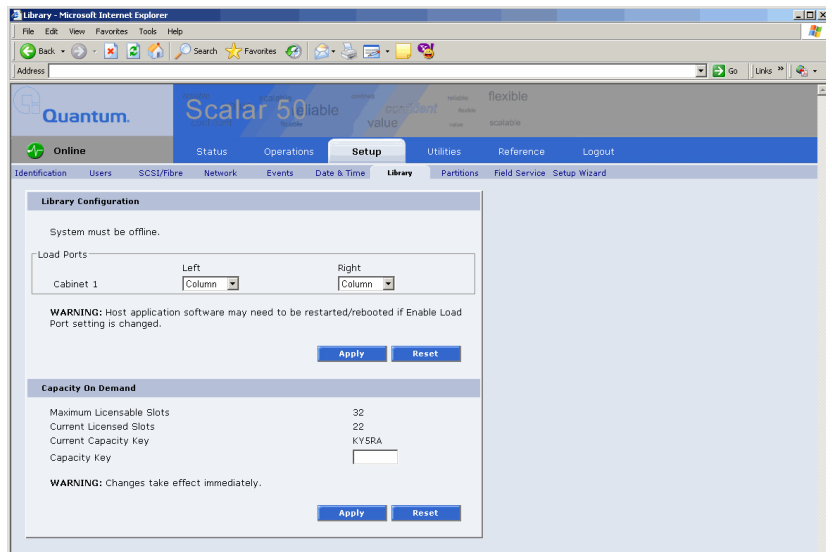

- 2 Edit the **Library Configuration** settings as desired (see [table 27](#) for a description of the fields) and click **Apply**.

Table 27 Library Configuration

Field	Description
Enable Left Load Port/Right Load Port	When enabled, the Left Load Port/Right Load Port will act as load ports. When disabled, they will be use as regular slots.

- 3 Click **Reset** to return the library to its original settings.

- 4 Enter the **Capacity Key** (see [table 28](#) for a description of the fields) and click **Apply**.

Note: Capacity on demand cannot be used in a partitioned library.

Table 28 Capacity on Demand Configuration

Field	Description
Maximum Licensable Slots	Displays the maximum number of slots that can be licensed in the library.
Current Licensed Slots	Displays the current number of slots licensed in the library. <ul style="list-style-type: none"> • 22 SDLT/26 LTO slots = Level 1 or default library capacity • 32 SDLT/38 LTO slots = Level 2 or full library capacity
Current Capacity Key	Displays the current capacity key for the library.
Capacity Key	To enable all of the available slots in the library (Level 1 to Level 2 capacity), enter the new capacity key for the library.

Caution: Changes to the number of licensed slots takes effect immediatly.

- 5 Click **Reset** to return the library to its original settings.

Partitions

Library partitioning provides the capability to divide the library's storage elements into separate partitions, usable by separate host computers on the same network. The maximum number of partitions per library is four partitions; however, the number of partitions is limited by the number of

installed tape drives. For example: in a Scalar 50 with two tape drives installed, only two partitions would be possible in this library.

Note: Partitioning cannot be used unless all libraries are at **FULL** capacity. See [“Library”](#) on page 125 for more capacity key information.

Partitioning Requirements

Only a Scalar 50 library with a **Native Fibre Channel interface** can support partitioning. You must also have a Fibre Channel switch available to connect to the library Fibre Channel SCB, Fibre Channel hosts, and native Fibre Channel tape drives. If you do not have a Fibre Channel switch available, the library is limited to one partition (see [figure 70](#)).

Figure 70 Native Fibre Channel Partition Example

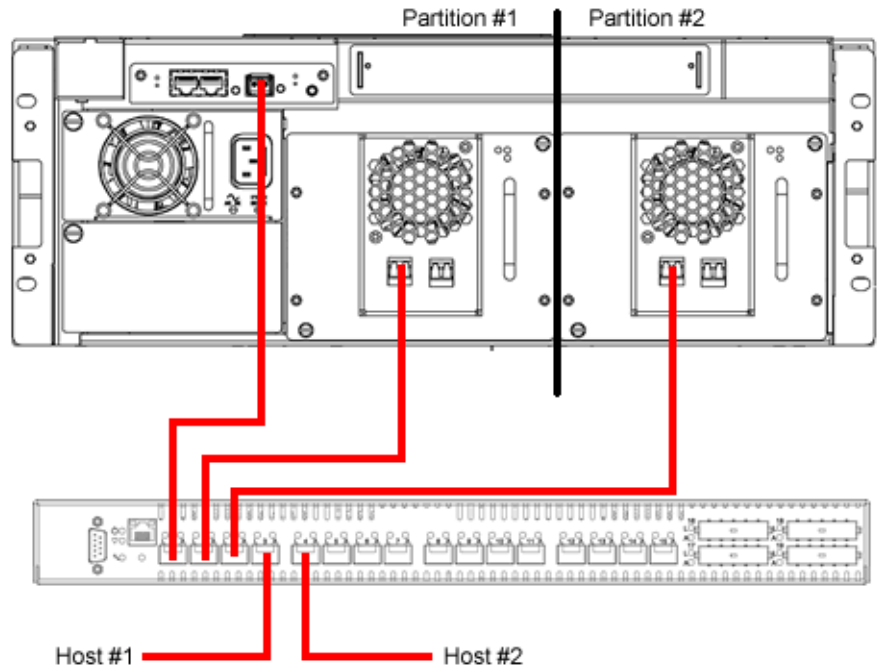

In the example shown in [figure 70](#), you must zone the Fibre Channel switch as follows:

- **Partition #1:** Zone 1 must have the media changer (port 1), tape drive 1 (port 2) and host 1 (port 4).

- **Partition #2:** Zone 2 must have the media changer (port 1), tape drive 2 (port 2) and host 2 (port 5).

Zoning the Fibre Channel switch as described above will allow the host to view only the tape drive for its specific partition. The media changer is visible to both partitions and hosts.

Scalar 50 Configurations that do NOT Support Partitioning

The following Scalar 50 configurations do NOT support partitioning:

- **Scalar 50 Libraries Containing SAS Tape Drives** - a library containing a HP LTO-4 Half Height tape drive cannot be partitioned.
- **Native Parallel SCSI interface** - a parallel SCSI library cannot support partitioning.
- **iSCSI bridged Parallel SCSI** - a parallel library with a TC2201 iSCSI bridge cannot support partitioning.
- **Native Fibre Channel without a switch** - a Native Fibre Channel library that does not have a Fibre Channel switch cannot support partitioning.
- **Scalar 50 with Level 1 Capacity** - A default capacity library with only four magazine columns available cannot be partitioned. You must have **FULL** capacity to partition the library.

Accessing the Partitions Page

To access the **Partitions** page, click **Partitions** from the **Setup** page.

The management frame displays the **Partitions** page (see [figure 71](#)).

Figure 71 Partitions Page

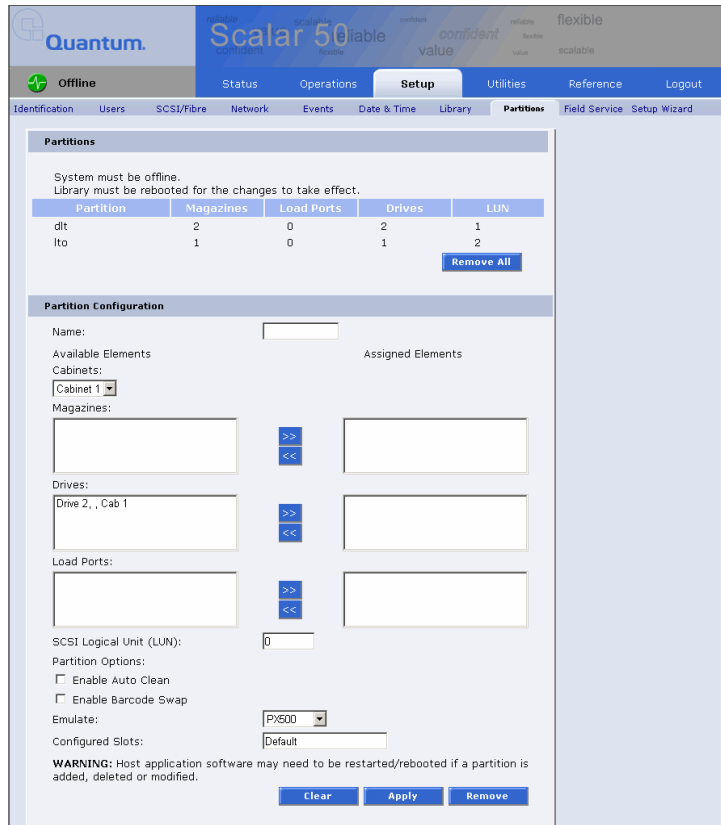

The **Partitions** page contains a list of all user defined partitions and a section for either creating a partition or changing a partition's configuration and options.

Clicking on a partition name in the **Partition** list displays a detail window listing all details for the selected partition.

Creating a Library Partition

To create a library partition:

Note: The library must be offline to create or edit a library partition.

- 1 Enter the partition information listed in [table 29](#) and click **New** to create the partition.

Table 29 Creating a Partition

Field	Description
Partition Name	Enter a unique name for the partition. Partition names must start with a letter (a-z or A-Z), cannot be longer than 10 characters, and cannot contain spaces or special characters. Library, Global, and Unassigned are reserved and cannot be used.
Cabinets	Select an available cabinet.
Magazines	Select one or more magazines from the unassigned magazine list and move it to the assigned magazine list. A partition MUST contain at least one magazine.
Drives	Select a drive or drives from the unassigned drives list and move it to the assigned drive list. A partition MUST contain at least one drive.
SCSI Logical Unit (LUN)	Enter the SCSI logical unit number for this partition. Each partition must have a unique LUN designation. The default number is 0.
Load Port	Select a load port from the load port list if required for this partition. Load port elements can be shared across multiple partitions.
Enable Autoclean	Select this box to automatically clean the drives in the partition when needed.
Emulate P-Series	Select this box to return an P-Series inquiry string to the host connected to this partition. The partition will appear to the host as an P-Series tape library.
Emulate Scalar 50	Select this box to return an Scalar 50 inquiry string to the host connected to this partition. The partition will appear to the host as an P-Series tape library.
Enable Barcode Swap	Enables/disables swapping media type prefix from the back of barcode to the beginning.

Field	Description
Configured Slots	The configured slots option allows you to designate the number of slots available and reported to the host. If you are reducing the slot count, the slots are reduced from the highest element address first. The element addressing begins with the left magazine, then the right magazine, and finally the fixed slots. This means that the first slots reduced are the fixed slots.

Editing a Library Partition

To edit a library partition:

Note: The library must be offline to create or edit a library partition.

- 1 Select the partition link under the **Partitions** section.
The area below the **Partitions** section displays the selected partition settings.
- 2 Edit the partition information as desired (refer to [table 29](#)) and click **Apply** to save the changes.
- 3 Click **Clear** to clear the partition settings and return to [Creating a Library Partition](#).

Deleting a Library Partition

There are two ways to delete partitions:

- 1 To delete a single library partition:
 - a Select the partition link under the **Partitions** section.

Note: When a partition is added, edited, or deleted the library must be rebooted for the changes to take effect.

- b Click **Remove** to delete the partition.
The library partition is deleted.

- 2 To delete all of the library partitions:
 - a Click **Remove All**.
All library partitions are deleted.

Field Service

The **Field Service** page is limited to Quantum Field Service only.

Setup Wizard

The **Setup Wizard** leads you through the process of setting up the most common options for this library to be operational. Detailed customization options, including settings modified by this wizard, can be changed via the menus under the **Setup** tab.

Note: The library will need to reboot for changes to take effect. Host application software may need to be restarted/rebooted as well.

- 1 To access the **Setup Wizard**, from the **Setup** page, click on the **Setup Wizard** tab at the top of the page.

The **Setup Wizard** displays (see [figure 72](#)).

Figure 72 Setup Wizard

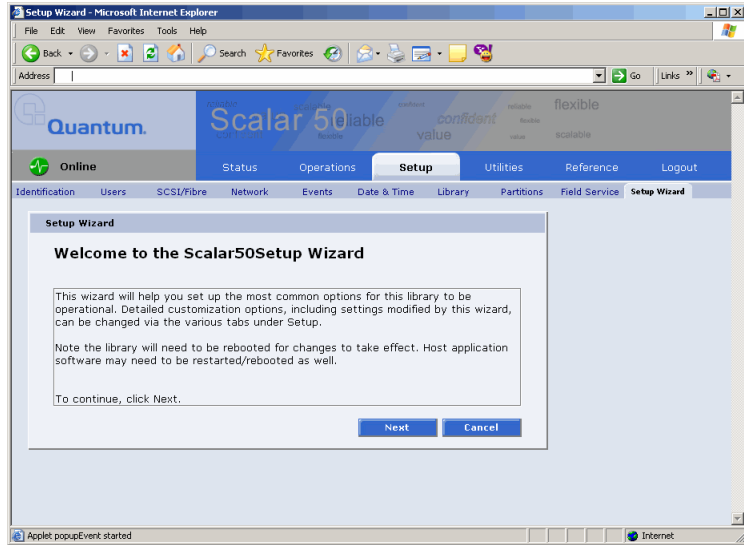

2 Click **Next** to continue.

The **Setup Wizard (Library Offline)** page displays (see [figure 73](#)).

Figure 73 Setup Wizard (Library Offline)

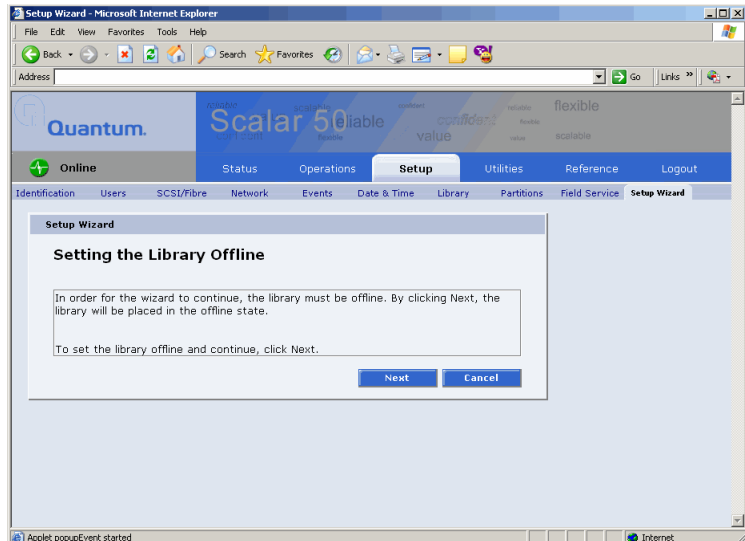

3 Click **Next** to turn the library offline and continue.

The **Setup Wizard (Date and Time)** page displays (see [figure 74](#)).

Figure 74 Setup Wizard (Date and Time)

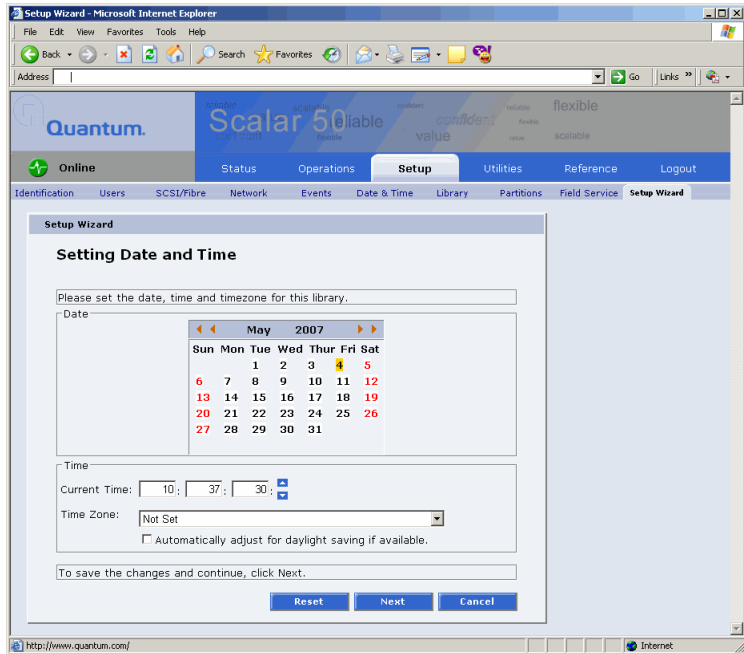

- 4 Set the system date and time using the **Change** button for the system date and drop down boxes for the system time.
- 5 Click **Next** to continue.

The **Setup Wizard (Configure Devices)** page displays (see [figure 75](#)).

Figure 75 Setup Wizard (Configure Devices)

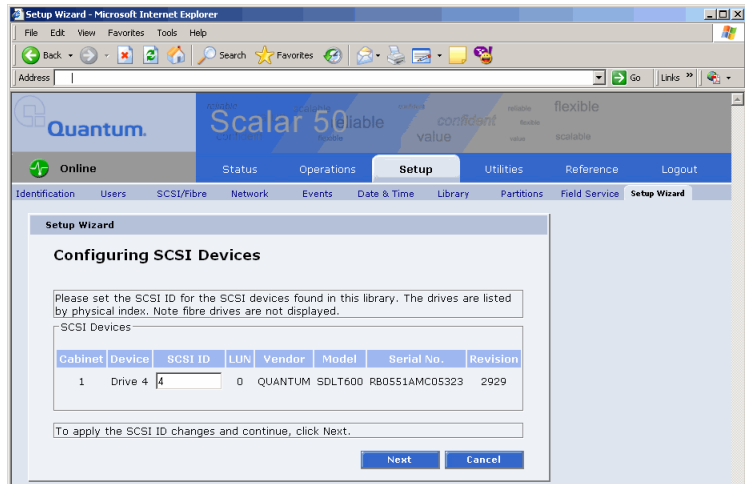

- 6 Set the SCSI ID for the SCSI devices in the library.
- 7 Click **Next** to continue.

The **Setup Wizard (Configuring Load Ports)** page displays (see [figure 76](#)).

Figure 76 Setup Wizard (Configuring Load Ports)

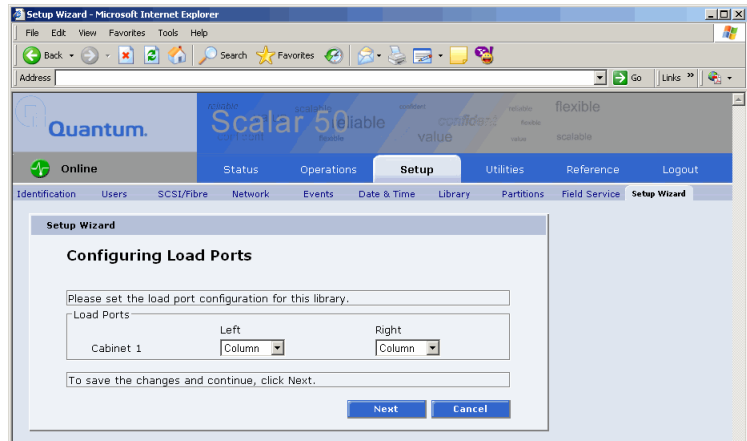

- 8 Enable or disable the load ports for this library.
- 9 Click **Next** to continue.

The **Setup Wizard (Configuring Partitions)** page displays (see [figure 77](#)).

Figure 77 Setup Wizard (Configuring Partition)

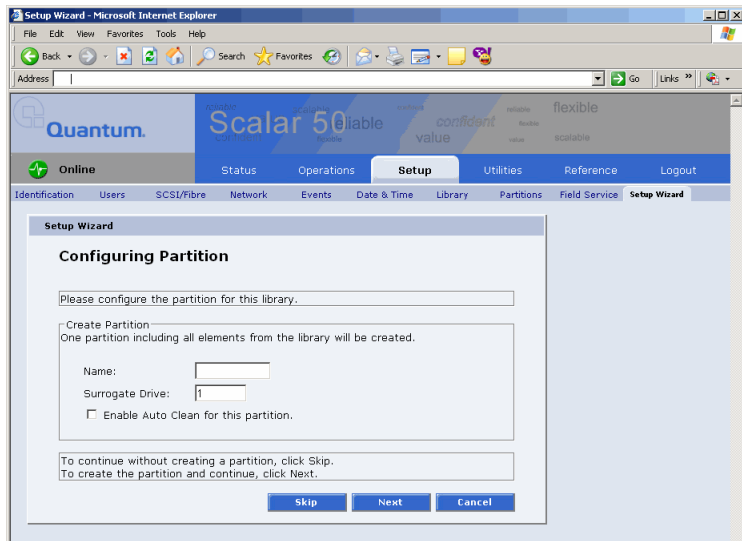

- 10 Create a partition for this library.
 - a Enter a name for the partition.
 - b Select a LUN for the partition.
 - c Enable/disable Auto Clean for this partition.
- 11 Click **Next** to continue.

The **Setup Wizard (Wizard Completed)** page displays (see [figure 78](#)).

Figure 78 Setup Wizard
(Wizard Completed)

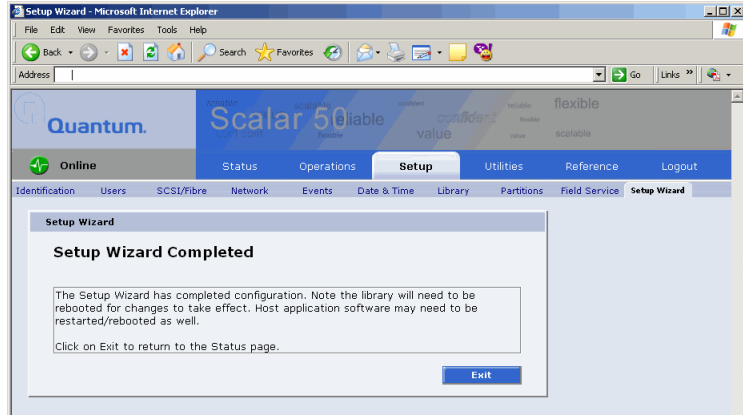

12 Click **Exit** to return to the **Status** page.

Note: You must reboot the library for the changes to take effect.

The **Setup Wizard** is complete.

Secure Key

The **Secure Key** tab displays when a secure user has been added to the library and the secure user is logged in.

Caution: If the secure key information is lost, any tape cartridges that were secured with the lost key will be unavailable for reading or writing.

To access the **Secure Key** page, from the **Setup** page, click on the **Secure Key** tab at the top of the page.

The **Secure Key** page displays (see [figure 79](#)).

Figure 79 Secure Key Page

Quantum Scalar 50 (Online) (Status) (Operations) (Setup) (Libraries) (Reference)

Identification Users SCSI/Fibre Network Events Date & Time Library **Secure Key**

Protection Mode for Cartridges

System must be offline to Modify Secure Key Mode.
Current Library Secure Key Name:

When enabled for a drive, the Secure Key will always be used for reading data from a cartridge in the drive.

Protection Mode Options for Writing a Secure Key to a Cartridge:

- Never Write Secure Key to a Cartridge.
- Only Write Secure Key to Blank Cartridges.
- Write Secure Key to All Cartridges (Blank & Formatted with Data).

NOTE: If 'All Cartridges' is selected, drives enabled for Secure Keys will write an encrypted secure key to all cartridges placed in the drive, including blank cartridges and formatted cartridges containing data. The data on these cartridges will only be accessible via drives using the same secure key.

Enable/Disable Secure Key for Drives

System must be offline to Enable/Disable Secure Key for Drives.

- Enable Secure Key for All Drives.
- Disable Secure Key for All Drives.

Cabinet	Drive	Model	Type	Serial No	Secure Key
31	0	DLT-54		CX0835AME00049	<input type="checkbox"/>

Select Secure Key for Library

System must be offline to Select Secure Key for Library.
Current Library Secure Key Name:

Secure Key Name, Date Created

Assign Secure Key to Cartridge

Find Secured Cartridges

Assigns a selected Secure Key to one or more cartridges (i.e. a cartridge imported from another system). Separate barcodes by spaces or commas. Selecting 'Remove' removes any association between a cartridge and a Secure Key.

Barcode

Secure Key Name, Date Created

Create Secure Key Name/Secure Key Pair

Secure Key Name

Secure Key

Verify Secure Key

Delete Secure Key & Secure Key Name

WARNING: Deleting a Secure Key removes it from the system's memory. Any cartridges requiring this Secure Key will be unreadable on this system unless the Secure Key is restored. Backing up the Secure Key file is strongly recommended before deleting any Secure Keys.

Unused Keys:

Secure Key Name, Date Created

Inactive Keys:

Secure Key Name, Date Created

Active Keys:

Secure Key Name, Date Created

Backup Secure Key File

NOTE: The Encryption Key of the Library is required when restoring a Secure Key File to a different Library. Please keep the Secure Key File's associated Encryption Key in a secure, but accessible location.

Encryption Key:

Verify Encryption Key:

Upload Secure Key File

Encryption Key (Required):

File Name:

The **Secure Key** page is divided into the following sections:

- [Protection Mode for Cartridges](#)
- [Enable/Disable Secure Key for Drives](#)
- [Select Secure Key for Library](#)
- [Assign Secure Key to Cartridge](#)
- [Create Secure Key Name/Secure Key Pair](#)
- [Delete Secure Key Name](#)
- [Backup Secure Key File](#)
- [Upload Secure Key File](#)

Protection Mode for Cartridges

Figure 80 Protection Mode for Cartridges

Refer to [figure 80](#) for information on **Protection Mode for Cartridges**.

Protection Mode for Cartridges

System must be offline to Modify Secure Key Mode.
Current Library Secure Key Name:

When enabled for a drive, the Secure Key will always be used for reading data from a cartridge in the drive.

Protection Mode Options for Writing a Secure Key to a Cartridge:

- Never Write Secure Key to a Cartridge.
- Only Write Secure Key to Blank Cartridges.
- Write Secure Key to All Cartridges (Blank & Formatted with Data).

NOTE: If 'All Cartridges' is selected, drives enabled for Secure Keys will write an encrypted secure key to all cartridges placed in the drive, including blank cartridges and formatted cartridges containing data. The data on these cartridges will only be accessible via drives using the same secure key.

The **Protection Mode for Cartridges** area defines when the secure key is used for a cartridge in a tape drive with a secure key enabled. In all modes, the secure key is used to read data from cartridges that have a pre-existing secure key. If the secure key on the cartridge does not match the current secure key on the library, the data on the cartridge can not be read.

Three write protection modes are available:

- **Never Write Secure Key to a Cartridge** - The secure key will never be written to a cartridge placed in a secured tape drive.
- **Only Write Secure Key to Blank Cartridges** - The secure key will only be written to blank, unformatted cartridges.
- **Write Secure Key to All Cartridges** - The secure key will be written to all cartridges, including blank and formatted cartridges containing data. This mode may be used to apply a secure key to cartridges with pre-existing data.

Enable/Disable Secure Key for Drives

Figure 81 Enable/Disable Secure Key for Drives

Refer to [figure 81](#) for information on **Enable/Disable Secure Key for Drives**.

Cabinet	Drive	Model	Type	Serial No.	Secure Key
31	0	DLT-S4		CX0535AMD00349	<input type="checkbox"/>

The secure key can only be used with tape drives that are secure key capable. This section lists the tape drives in the library that are secure key capable. A checkmark in the **Secure Key** column indicates a secure key is enabled for the tape drive.

- 1 The secure key can be enabled or disabled for all tape drives by clicking the corresponding radio button.
- 2 Click the **Secure Key** check box for individual tape drives to enable/disable secure key for a tape drive.
- 3 Click **Update** to activate the changes.

Note: The system must be offline to Enable/Disable Secure Key setting for drives.

Select Secure Key for Library

Figure 82 Select Secure Key for Library

Refer to [figure 82](#) for information on **Select Secure Key for Library**.



Select Secure Key for Library

System must be offline to Select Secure Key for Library.

Current Library Secure Key Name:

Secure Key Name, Date Created

To select the secure key used by the library:

- 1 Select the secure key name from the list of available names.

Note: Selecting **None** will cause the library to NOT use a secure key.

- 2 Click **Update**.

Note: The system must be offline to modify a secure key.

Assign Secure Key to Cartridge

Figure 83 Assign Secure Key to Cartridge

Refer to [figure 83](#) for information on **Assign Secure Key to Cartridge**.

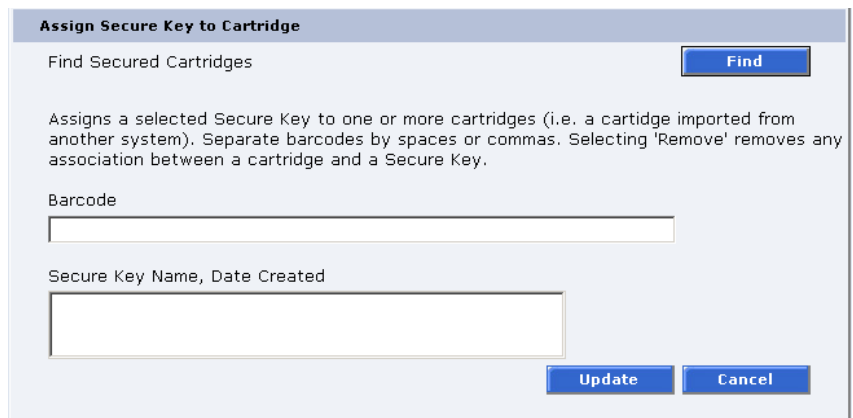

Assign Secure Key to Cartridge

Find Secured Cartridges

Assigns a selected Secure Key to one or more cartridges (i.e. a cartridge imported from another system). Separate barcodes by spaces or commas. Selecting 'Remove' removes any association between a cartridge and a Secure Key.

Barcode

Secure Key Name, Date Created

Click **Find** to list all secured cartridges and their assigned secure key names.

To assign a secure key to a cartridge:

- 1 Enter the barcode of the cartridge. Separate multiple barcodes with either spaces or commas.
- 2 Select a secure key name from the list of available names.
- 3 Selecting **Remove** will remove the association between the cartridge and a secure key name in the cartridge database.
- 4 Click **Update** to accept the changes.

Create Secure Key Name/ Secure Key Pair

Refer to [figure 84](#) for information on **Create Secure Key Name/Secure Key Pair**.

Figure 84 Create Secure Key
Name/Secure Key Pair

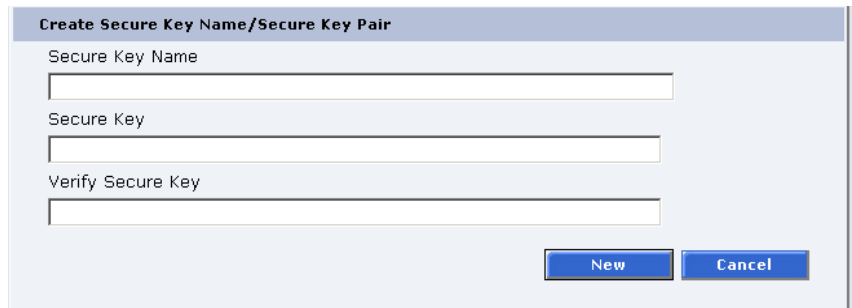

The screenshot shows a dialog box titled "Create Secure Key Name/Secure Key Pair". It features three text input fields: "Secure Key Name", "Secure Key", and "Verify Secure Key". At the bottom right, there are two buttons: "New" and "Cancel".

To create a secure key name/secure key pair:

- 1 Enter the **Secure Key Name**.

Note: The secure key name must be less than 12 characters, may include spaces, but cannot contain the following characters: () = ;

- 2 Enter a securekey in the protected **Secure Key** field.

- 1 Select the desired **Secure Key Names** from the available lists.
- 2 Click **Delete**.

A confirmation message will be displayed, click **Yes** to continue.

Any tape drives that have been secure key enabled will remain enabled, but the secure key will not be used to read or write cartridges.

Backup Secure Key File

Figure 86 Backup Secure Key File

Refer to [figure 86](#) for information on **Backup Secure Key File**.

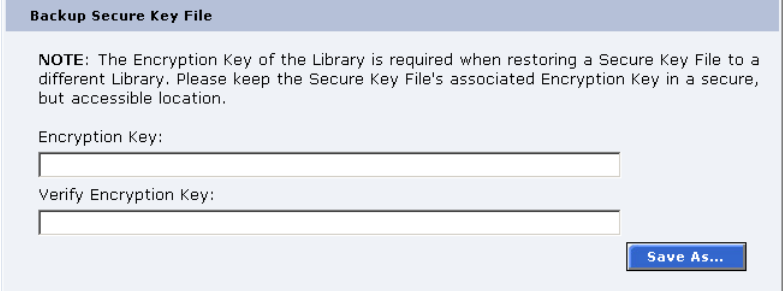

The screenshot shows a dialog box titled "Backup Secure Key File". It contains a note: "NOTE: The Encryption Key of the Library is required when restoring a Secure Key File to a different Library. Please keep the Secure Key File's associated Encryption Key in a secure, but accessible location." Below the note are two text input fields: "Encryption Key:" and "Verify Encryption Key:". A "Save As..." button is located in the bottom right corner of the dialog box.

The list of **Secure Key Name/Secure Key Pairs** maintained on the library should be backed up to a local device whenever a change is made to the security keys.

Note: Note the library's **Encryption Key**. The **Encryption Key** is required when restoring the file to any library.

- 1 Click **Save As...**
The browser displays a download link.
- 2 Right-click on the download link and select **Save As...** to select a path and name the file.
- 3 Click **OK**.

Upload Secure Key File

Figure 87 Upload Secure Key File

Refer to [figure 87](#) for information on **Upload Secure Key File**.

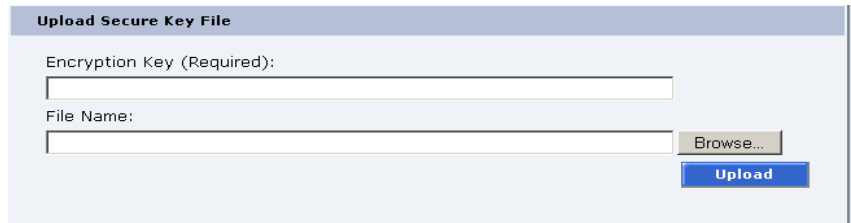

The screenshot shows a web form titled "Upload Secure Key File". It contains two input fields: "Encryption Key (Required):" and "File Name:". To the right of the "File Name:" field is a "Browse..." button. Below the "File Name:" field is a blue "Upload" button.

A file containing a list of **Secure Key Name/Secure Key Pairs** can be restored to the library.

Note: The user defined encryption key of the library originally maintaining the list is required to restore the file.

To upload (restore) a **Secure Key File**:

- 1 Enter the encryption key of the original library.
- 2 Enter the path and file name of the file to be uploaded (click **Browse...**)
- 3 Click **Upload** button.

A progress window is displayed indicating when the upload is complete or if any errors occurred during the upload or restoration of the file.

The **Secure Key** page is refreshed listing restored secure keys.

Note: An error is displayed if the encryption key provided does not match the encryption key used to encode the secure keys.

Secure Key Best Practices and Tape Migration

This section provides information on “Best Practices” when implementing DLTSage Tape Security and also instructions for migrating your security keys from one library to another.

For more information on implementing DLTSage Tape Security with your specific library, refer to the following Quick Start Guides provided on the documentation CD included in the library accessory kit:

- *Scalar 50 DLTSage Tape Security Quick Start Guide* PN 81-81627
- *PX720 DLTSage Tape Security Quick Start Guide* PN 81-81588

Best Practices

When implementing DLTSage Tape Security in your tape library, there are several “Best Practices” or guidelines to consider:

- The encryption key file should be saved off of the library at least once a month or whenever a large amount of tapes is removed/added to the library. It is a good idea to use the date in the file name of the backup file.
- In the library remote management pages, the secure key and tape cartridge barcode associations are displayed when you click Find in the Assign Secure Key to Cartridge section without a specific barcode entered in the barcode edit box. You should save this file off of the library so the secure key and barcode associations are available in case of disaster recovery or when moving the tapes from one library to another. This also makes it easy to copy and paste the barcode numbers into the PX720 and Scalar 50 remote management pages when associating barcodes with secure keys.
- Secure key and encryption password information should NOT be stored in unsecured areas.

Key Migration Scenarios

The following examples describe two key migration scenarios:

- [Disaster Recovery Scenario](#)
- [Tape Cartridge Migration Scenario](#)

Disaster Recovery Scenario

In the disaster recovery scenario, the original library is inoperable, but secure keys and barcode associations have been saved off of the system and are available on the network.

- 1 Remove the tape cartridges and place them in another tape security enabled library.
- 2 Follow the steps listed below (beginning with step 2) to import cartridges and associate barcodes with secure keys.

Tape Cartridge Migration Scenario

In this tape cartridge migration example, tape cartridges have been secured in one tape library (PX720 or Scalar 50) and you want to move them into another PX720 or Scalar 50 library and access them:

- 1 On the original library containing the cartridges:
 - a Access the library remote management screens.
 - b In the **Backup Secure Key** file section, backup the secure key file. This encrypted file contains all of the secure keys and bar code associations in the original library. Once you click **Save as...** you must right-click on the download link to save the file local directory. This file must be located on a network resource that is available to the new library.
 - c Export the tape cartridges from the library.
- 2 On the new library:
 - a Import the tape cartridges into the new library.
 - b Upload the secure key file from the original library:
 - If you are uploading a backup file from a PX720 to a Scalar 50 library, you must enter the serial number of the original PX720 in the **Encryption Key** field, browse to the backup file, and click **Upload**.
 - If you are uploading a file from a Scalar 50 library to a PX720, you must enter the user defined key name in the **Serial number** field, browse to the backup file, and click **Upload**.
 - c When the file is uploaded, the secure keys from the original library display in the secure key name list.

The tape cartridges are now available for reading and writing.

Utilities

The **Utilities** page is divided into the following sections:

- [Library](#)
- [System Tests](#)
- [Maintenance](#)
- [Logs](#)
- [Tasks](#)

- 1 To access the **Utilities** page, from the **Overview** page, click on the **Utilities** tab at the top of the page.

The **Utilities** page displays (see [figure 88](#)):

Figure 88 Utilities Page

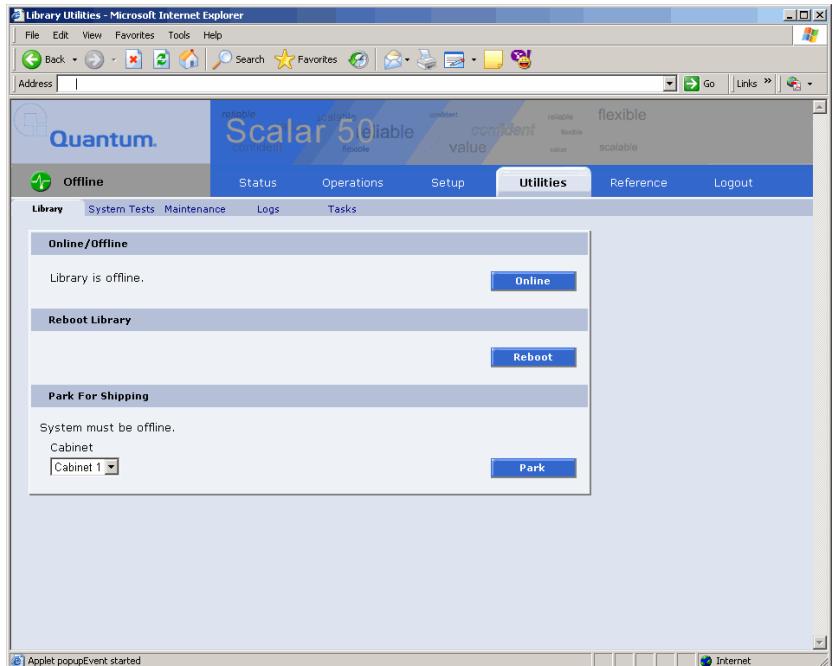

Library

The library page is divided into the following sections:

- [Online/Offline](#)
- [Reboot Library](#)
- [Park for Shipping](#)
- [Bridge Rescan](#)

To access the **Library** page, from the **Utilities** page, click on the **Library** tab at the top of the page.

The **Library** page displays (see [figure 89](#)):

Figure 89 Library Page

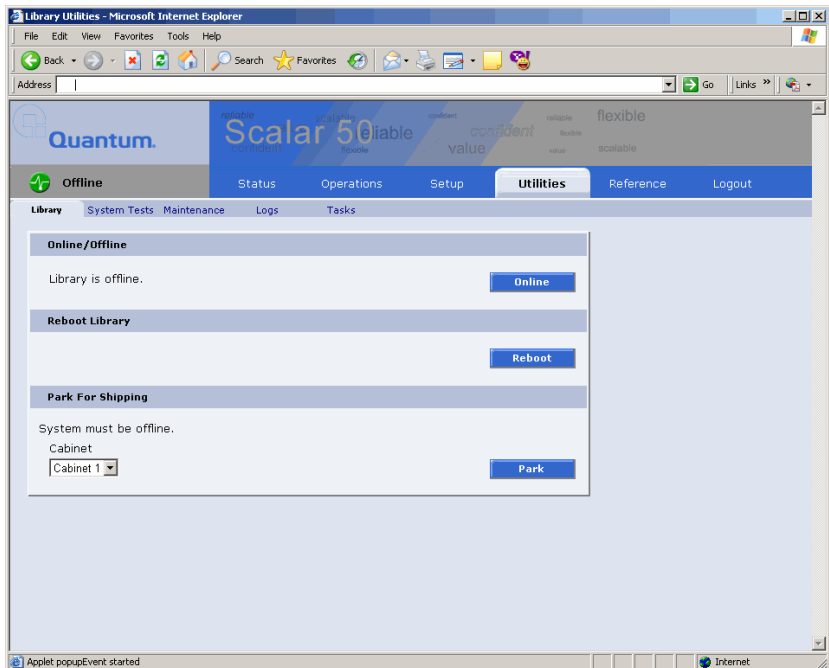

Online/Offline

The online/offline button allows the user to turn the cabinet online or offline remotely. The action displayed on the button will depend on the current state of the library or cabinet. If the library (cabinet) is online, **Offline** button will be displayed. If the library (cabinet) is in the offline state, an **Online** button will be displayed.

To change the library online/offline:

- 1 Click the button to change the library state to online or offline.

The library changes state to online or offline.

Reboot Library

The **Reboot Library** button allows you to remotely reboot the library.

To reboot the library:

- 1 Click **Reboot**.

The library reboots.

Park for Shipping

Note: You must remove all tape cartridges from the library prior to parking the library robotics for shipment.

The **Park for Shipping** button allows you to remotely park the robot for library shipment. This places the library hand in the correct position for shipment and powers down the library, **HOWEVER**, you must place the library hand restraint on the library hand prior to shipping the library. Refer to [appendix D](#) on page 216 for more information on shipping the library.

Caution: Shipping the library without installing the library hand restraint may result in damaging the hand.

To park the library hand:

- 1 Select the cabinet and click the **Park** button.

The library hand moves to the shipment position.

Bridge Rescan

Note: The **Bridge Rescan** button only displays if a TC2201 iSCSI bridge is installed in the library.

The bridge rescan button re-discovers any iSCSI bridges installed in the cabinet. Details of the scan will be presented under **Bridges** tab.

To rescan iSCSI bridges installed in the cabinet:

- 1 Click **Rescan**.

The iSCSI bridges are scanned.

System Tests

The system tests section allows the user to run a series of tests on an individual cabinet axis.

- 1 To access the **System Test** page, from the **Utilities** page, click on the **System Test** tab at the top of the page.

The **System Test** page displays (see [figure 90](#)).

Figure 90 Selftest Page

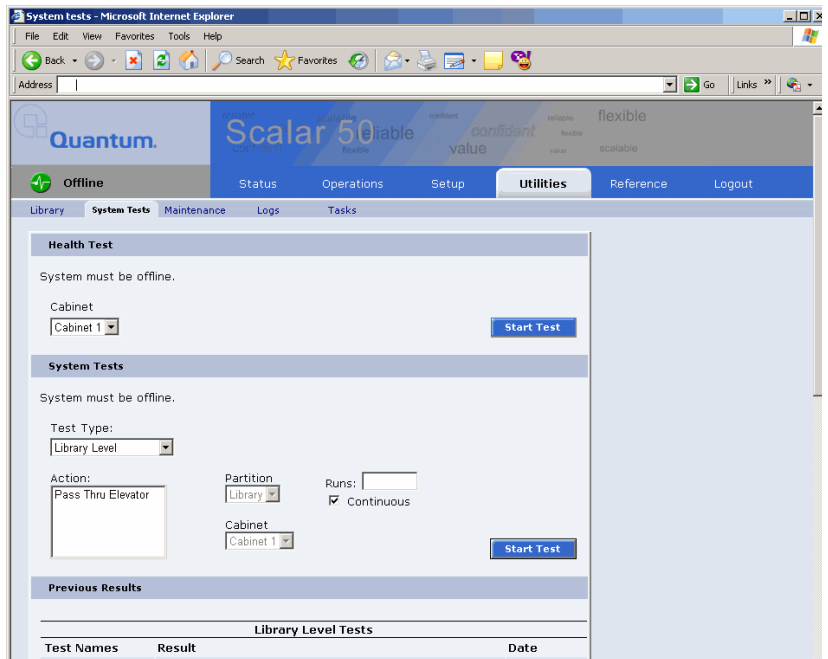

To run a **Health Test** on a cabinet:

Note: The library must be off-line before executing any health tests.

- 1 Click the **Start Test** button.

The system performs a health test on all robotic axis. Previous test results can be viewed below.

System Tests

The system test section allows the user to run a series of tests on an individual cabinet axis.

- 1 To access the **System Tests** page, from the **Utilities** page, click on the **System Tests** tab at the top of the page.

The **System Tests** page displays (see [figure 91](#)).

Figure 91 System Tests Page

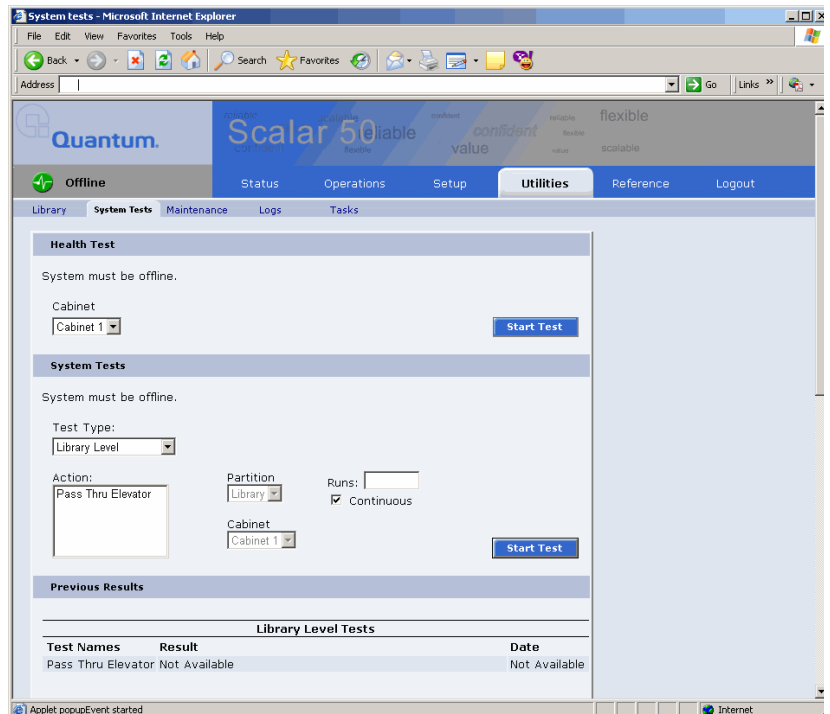

To run a **System Test** on a cabinet:

Note: The library must be off-line before executing any system tests.

- 1 Select an action and a number of runs and click **Apply**.

The cabinet performs the system test. If you leave the runs field empty, the system test will run continuously until you abort the system test. Previous test results can be viewed below.

Maintenance

The maintenance section allows the user to backup or restore system configuration files as well as upload new cabinet and tape drive firmware.

- 1 To access the **Maintenance** page, from the **Utilities** page, click on the **Maintenance** tab at the top of the page.

The **Maintenance** page displays (see [figure 92](#)).

Figure 92 Maintenance Page

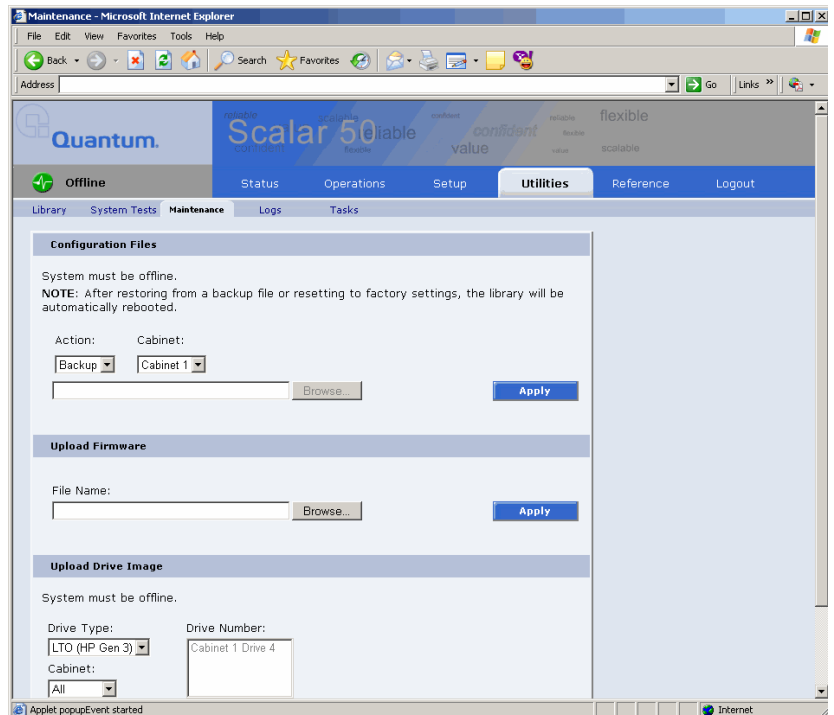

Configuration Files

Configuration files contain all of the configurable information on the library (see [table 30](#) for file types). This configuration file should be saved on a local host on the same network. If the library configuration file is corrupted, this backup configuration file can be uploaded back to the library without reconfiguring the entire library.

Table 30 Configuration File Types

Configuration File Type	Description
Backup	Select Backup to save all user, network, and library configuration information. Use this file to replace all configurable options on the library.
Restore	Select Restore to restore a configuration file from your computer to the library.
Factory	Select Factory to restore the library to its default factory configuration settings.

- 1 Select file type and click on **Apply**.

Note: After restoring configuration files or factory default settings, the library will automatically reboot.

Upload Firmware

The upload firmware section allows the user to remotely upload new firmware to the library.

Note: If you are uploading library firmware to stacked libraries, refer to [Appendix E](#) on page 226 for special instructions.

To upload firmware:

- 1 Enter a path and filename where the file exists, or click **Browse**.
- 2 Click **Apply** to upload the file.

The firmware image uploads to the library and reboots the library.

Upload Drive Image

The upload drive image section allows the user to remotely upload new tape drive firmware to a specific tape drive within the library.

To upload drive firmware:

Note: The library must be offline to update the drive firmware.

- 1** Select an individual tape drive and number or select an entire cabinet to update the drive firmware for all tape drives within the library cabinet.
- 2** Enter a path and filename where the tape drive firmware exists, or click **Browse**.
- 3** Click **Apply** to upload the file.

The firmware image uploads to the tape drive(s) and reboots the library.

Logs

The **Logs** page displays the drive logs for the individual tape drives within the library and also a failure analysis file.

To access the **Logs** page, from the **Utilities** page, click on the **Logs** tab at the top of the page.

The **Logs** page displays (see [figure 93](#)):

Figure 93 Logs Page

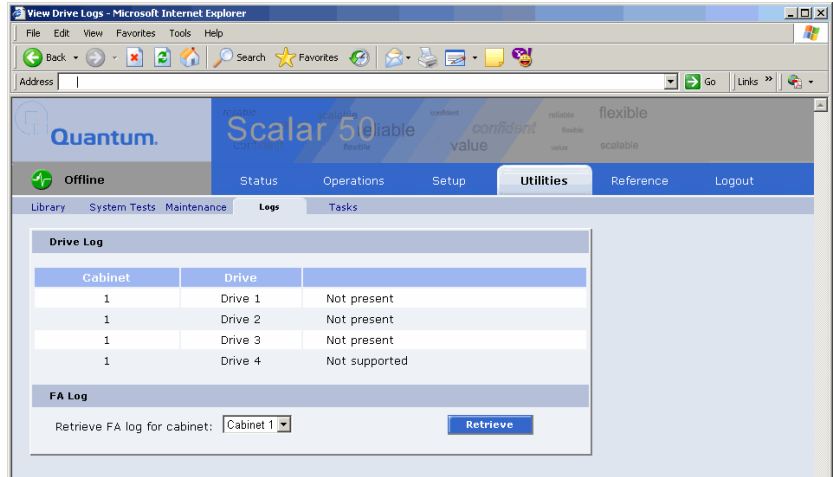

Click the **View Log** link to view the log file for a specific tape drive (see [figure 94](#)). The log sense information for the tape drive displays. Click **Next** to see additional log sense information.

Figure 94 View Log Page

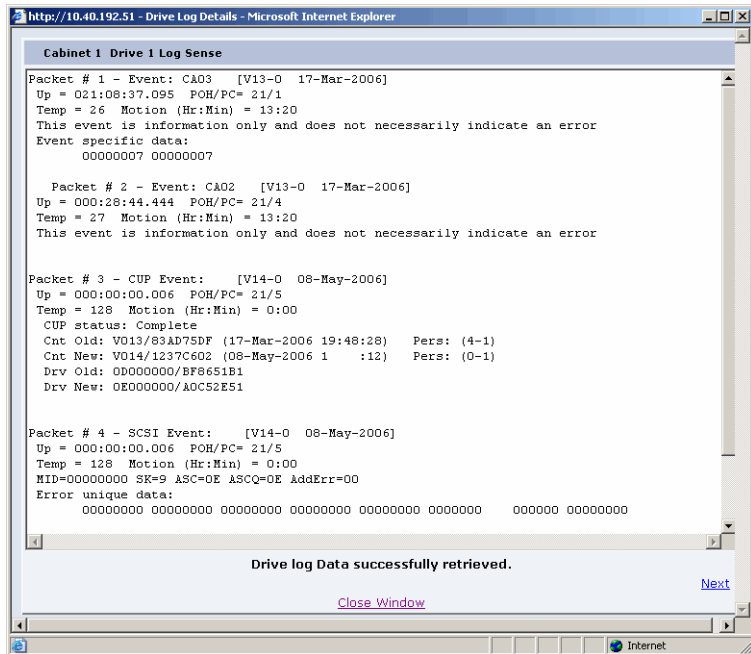

FA Log File

The failure analysis log file (FA log) contains diagnostic information used to troubleshoot problems with the library. This file can only be used by Quantum Customer Support. Have this file available prior to calling Quantum Customer Support.

Note: It is recommended to turn the library offline prior to collecting an FA log.

To retrieve a FA log file:

1 Click **Retrieve**.

A window displays with the status of the FA log download process. This will take several minutes. Once the command to retrieve the library FA log has completed, click the **Download FA Log** link to save the file to your local computer.

Tasks

The **Tasks** page displays the last fifteen tasks that have been performed on the library that required a status window. Clicking the task link displays the task window whether it is still in progress or finished.

To access the **Tasks** page, from the **Utilities** page, click on the **Tasks** tab at the top of the page.

The **Tasks** page displays (see [figure 93](#)):

Figure 95 Tasks Page

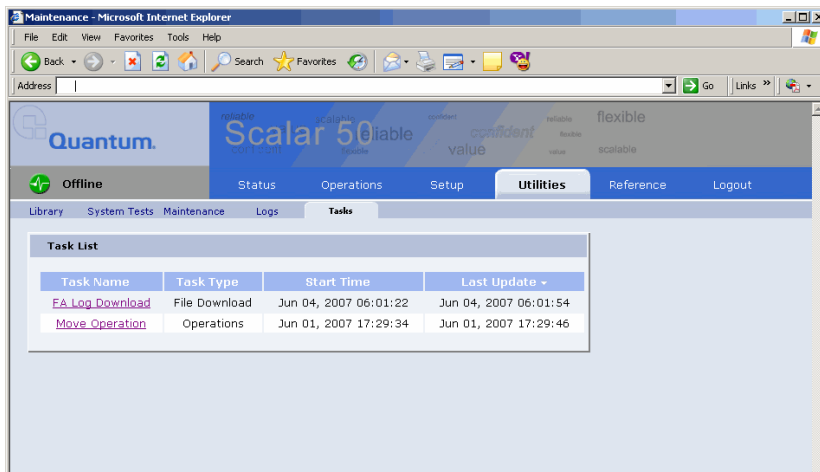

In the example above, a **Move Operation** task is displayed in the **Task Name** list. Clicking the **Move Operation** link displays the following page (see [figure 96](#)).

Figure 96 Task List Example

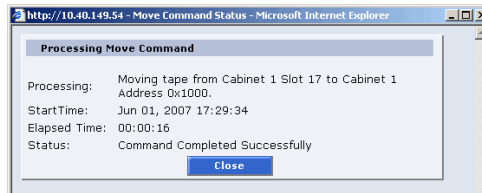

The page indicates that a move command has completed moving a tape from cabinet 1 slot 17 to cabinet 1 address 0x1000, the start time and elapsed time for the command to complete.

Reference

The links on this page provide access to various points of interest which may be helpful in the operation and support of your library. Your browser must have access to the internet for these links to work.

- 1 To access the **Reference** page, click on the **Links** tab at the top of the page.

The **Links** page displays (see [figure 97](#)).

Figure 97 Reference Page

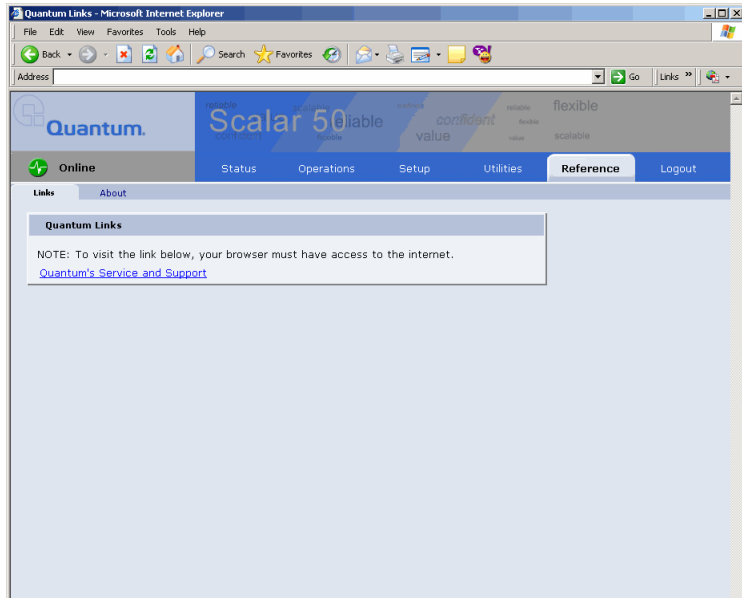

- 2 To access the **About** page, click the **About** tab at the top of the page. The **About** page displays the model number, software version, serial number, and slot/drive configuration (see [figure 98](#)).

Figure 98 About Page

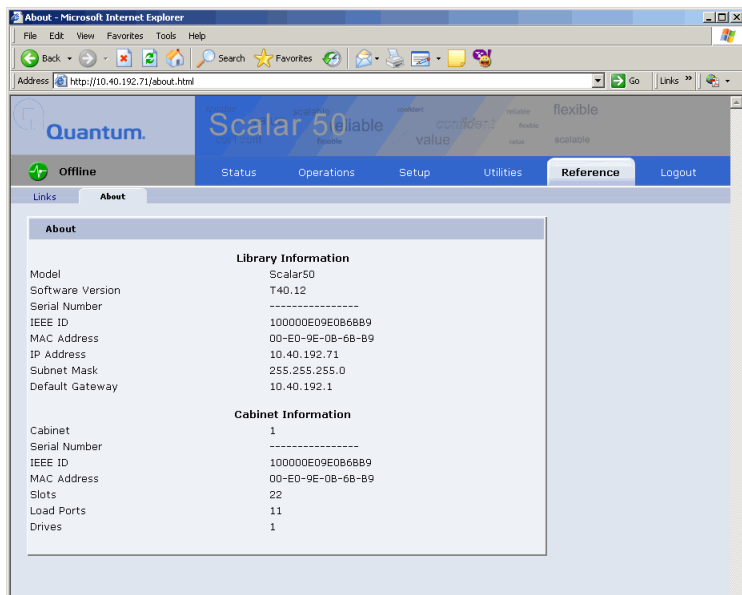

Logout

The **Logout** page allows you to logout of the Scalar 50 remote management pages.

To logout of the library remote management pages, click **Logout**.

The session is closed. Start a new session by re-authenticating when prompted or close your browser.

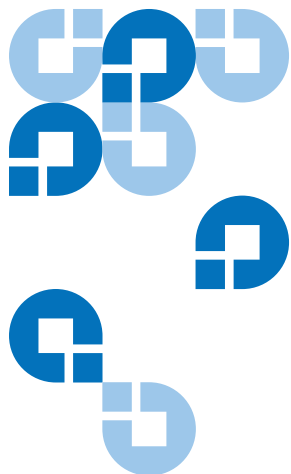

Chapter 4

SNMP Trap List

This chapter provides the supported SNMP trap list for the Scalar 50 tape libraries. The following table is sorted by the **Reported By** column:

- 1 Code Update**
- 2 Diagnostic**
- 3 Drive Manager**
- 4 Event Manager**
- 5 Image Process**
- 6 OCP**
- 7 SCSI**
- 8 Servo**
- 9 System Manager**
- 10 System Monitor**

Event Details - indicates the text that appears on the OCP and also in the Remote Management web pages.

Event Description - provides a more detailed description of the event that occurred.

Category - indicates the type of SNMP trap (**Informational**, **Warning**, or **Critical**)

Reported By - indicates the area of firmware that reported the event.

Event Detail	Event Description	Category	Reported By
Start Backup System Codeupdate (type/dest)	A backup flash update was attempted.	Informational	Code update
Start Sled Codeupdate (type/dest)	A drive sled update was attempted.	Informational	Code update
Start Drive Codeupdate (type/dest)	A drive update was attempted.	Informational	Code update
Loader Image size larger than hdr entry (image size)	The library failed the version verification test.	Critical	Code update
Loader Image size smaller than hdr entry (image size)	The library failed the version verification test.	Critical	Code update
Loader Image too large for allocated memory (image size)	The library failed the version verification test.	Critical	Code update
Invalid boot image	The boot code used to initialize the system is invalid. Update the library firmware with the latest version of code.	Critical	Code update
Invalid drive image (type/dest)	The tape drive software downloaded into the library memory is invalid.	Critical	Code update
Invalid system image (location)	The library software used for system operation is invalid. Update the library firmware with the latest version of code.	Warning	Code update
Start System Codeupdate (type/dest)	A loader update was attempted.	Informational	Code update
Codeupdate successful (type/dest)	A code update has completed.	Informational	Code update

Event Detail	Event Description	Category	Reported By
Codeupdate failed (status)	A code update has failed.	Informational	Code update
Backplane nv erase err (region id/status)	Non Volatile memory on the back plane could not be erased. Replace the backplane to restore normal library operations.	Critical	Diagnostics
Backplane nv read err (region id/status)	Non Volatile memory on the back plane could not be read. Replace the backplane to restore normal library operations.	Critical	Diagnostics
Backplane nv write err (region id/status)	Non Volatile memory on the back plane could not be written. Replace the backplane to restore normal library operations.	Critical	Diagnostics
Hand-camera image fail	The camera in the robotics hand has failed to read an image.	Critical	Diagnostics
Hand-camera init fail	The camera in the robotics hand has failed its initialization routine.	Critical	Diagnostics
Selftest Camera FIFO failure	The camera in the robotics hand has failed to read its memory used to transfer data.	Critical	Diagnostics
Selftest display bram failure	The diagnostic buffer used to report test results is not large enough to hold the data.	Critical	Diagnostics
Scb-fpga camera fifo fail	The memory on the system controller board has failed to read the memory used to transfer data.	Critical	Diagnostics
Test details buffer overflow (len/ testId)	The diagnostic buffer used to report test results is not large enough to hold the data.	Critical	Diagnostics
Test record semaphore locked (index/tx-status)	An internal firmware error has occurred.	Critical	Diagnostics

Event Detail	Event Description	Category	Reported By
Test structure corrupt (testId)	An internal firmware error has occurred.	Critical	Diagnostics
Insufficient num cart for test (num)	Not enough tape cartridges in the library to complete the system test.	Warning	Diagnostics
Insufficient num drives for test (num)	Not enough tape drives in the library to complete the system test.	Warning	Diagnostics
Insufficient num empty slots for test (num)	Not enough empty bins in the library to complete the system test.	Warning	Diagnostics
Hand-cal offset fail	The calibration test used to compute offsets for the robotic hand has failed.	Critical	Diagnostics
Hand-theta cal offset fail	The calibration test used to compute offsets for the robotic hand in rotation has failed.	Critical	Diagnostics
Hand-trans cal offset fail	The calibration test used to compute offsets for the robotic hand in translation has failed.	Critical	Diagnostics
XY & hand cal offset fail	The calibration test used to compute offsets for the robotics tray has failed.	Critical	Diagnostics
XY & hand_theta cal offset fail	The calibration used to compute offsets for the robotics tray and robotics hand has failed.	Critical	Diagnostics
XY & hand_trans cal offset fail	The calibration test used to compute offsets for the robotics tray and robotics rotation has failed.	Critical	Diagnostics
XY & Z cal offset fail	The calibration test used to compute offsets for the robotics tray and the robotics up/down motion has failed.	Critical	Diagnostics

Event Detail	Event Description	Category	Reported By
XY-cal offset fail	The calibration test used to compute offsets for the robotics tray has failed.	Critical	Diagnostics
Z & hand cal offset fail	The calibration test used to compute offsets for the robotics tray up/down and robotics hand has failed.	Critical	Diagnostics
Z & hand_theta cal offset fail	The calibration test used to compute offsets for the robotics tray up/down and robotics hand rotation has failed.	Critical	Diagnostics
Z & hand_trans cal offset fail	The calibration test used to compute offsets for the robotics tray up/down and robotics hand translation has failed.	Critical	Diagnostics
Z-cal offset fail	The calibration test used to compute offsets for the robotics tray up/down has failed	Critical	Diagnostics
Hand-trans axis init fail	The robotic hand could not initialize the translation axis.	Critical	Diagnostics
Hand-trans home fail	The robotic hand could not home the translation axis.	Critical	Diagnostics
Hand-trans motor fail (zone #)	The robotic hand has failed to position translation to a predetermined physical location.	Critical	Diagnostics
Hand-theta axis fail (zone #)	The robotic hand has failed to position rotation to a predetermined physical location.	Critical	Diagnostics
Hand-theta axis init fail	The robotic hand could not initialize the rotation axis.	Critical	Diagnostics
Hand-theta home fail	The robotic hand could not home the rotation axis.	Critical	Diagnostics

Event Detail	Event Description	Category	Reported By
Hand-theta motor fail (zone #)	The robotic hand has failed to position rotation to a predetermined physical location.	Critical	Diagnostics
Hand-theta neg position fail (zone #)	The robotic hand has failed to position rotation to a predetermined physical location.	Critical	Diagnostics
Hand-theta pos position fail (zone #)	The robotic hand has failed to position rotation to a predetermined physical location.	Critical	Diagnostics
Hand-theta position fail	The robotic hand has failed to position rotation to a predetermined physical location.	Critical	Diagnostics
API msg que send shutdown err (tx-status)	An internal API could not send a shutdown message.	Critical	Diagnostics
API send response que err (tx-status/fromId)	An internal API received a command message error.	Critical	Diagnostics
API send test msg que err (tx-status/fromId)	An internal API received a command message error.	Critical	Diagnostics
Bad sender for get resp que (taskId/sender)	An internal API received a command message error.	Critical	Diagnostics
Create main msg que err (tx-status)	An internal API received a command message error.	Critical	Diagnostics
Create response msg que err (tx-status)	An internal API received a command message error.	Critical	Diagnostics
Main msg que receive err (tx-status)	An internal API received a command message error.	Critical	Diagnostics
Response msg que receive err (tx-status)	An internal API received a command message error.	Critical	Diagnostics
Create test record semaphore err (tx-status)	An internal API received a command message error.	Critical	Diagnostics

Event Detail	Event Description	Category	Reported By
Ralu rnd number generator reset	The random number generator used to calculate the slot locations for the internal Random Access Load Unload (RALU) function has been reset.	Informational	Diagnostics
Elem move failed limits check	A move to an element failed a calibration limit.	Warning	Diagnostics
Hand-communication fail	The communications to the robotic hand has failed.	Warning	Diagnostics
XYZ-communication fail	The communication to the robotic hardware for moving the X,Y and Z axis has failed.	Warning	Diagnostics
Timeout waiting for response (status/taskId)	A command sent by the diagnostics module has timed out waiting for a return from another module in the system.	Critical	Diagnostics
Z-axis init fail	The Z (vertical) axis initialization routine has failed.	Critical	Diagnostics
Z-motor fail (zone #)	The robotic hand has failed to position the vertical axis to a predetermined physical location.	Critical	Diagnostics
Z-position fail (zone #)	The robotic hand has failed to position the vertical axis to a predetermined physical location.	Critical	Diagnostics
X-position fail (zone #)	The robotic hand has failed to position the XY axis to a predetermined physical location.	Critical	Diagnostics
XY-home fail	The XY axis initialization routine has failed to find its home position.	Critical	Diagnostics
XY-motor fail (zone #)	The robotic hand has failed to position the XY axis to a predetermined physical location.	Critical	Diagnostics

Event Detail	Event Description	Category	Reported By
XY-position fail	The robotic hand has failed to position the XY axis to a predetermined physical location.	Critical	Diagnostics
XY-safe to rotate fail	The safe to rotate sensor used to home the XY axis could not be seen by the calibration routine.	Warning	Diagnostics
Y-position fail (zone #)	The robotic hand has failed to position the XY axis to a predetermined physical location.	Critical	Diagnostics
Bad SCSI Sense Data	A command sent to the drive received bad sense data.	Warning	Drive Manager
Aborted any open exchanges	Drive communications has failed.	Informational	Drive Manager
ADT login failed	The library failed to login and set up communication to a drive.	Critical	Drive Manager
Bad reply received	The drive did not return a valid response.	Warning	Drive Manager
Login failed, too many retries	The library could not initiate communications with the drive.	Warning	Drive Manager
Login failed, no response	Drive did not respond correctly to the login command sequence.	Warning	Drive Manager
Unexpected login, not handled or requested	The drive unexpectedly sent a login request.	Informational	Drive Manager
ACI invalid Response	The HP Gen 2 Drive returned an invalid command response.	Warning Critical	Drive Manager
Command Id not supported	This command is not supported by the drive.	Critical	Drive Manager
Could not send adt logout	Drive communications (possibly due to hardware) is lost.	Critical	Drive Manager
Message Id not supported	Command is not supported by the drive.	Critical	Drive Manager

Event Detail	Event Description	Category	Reported By
Response ServiceType not supported	The drive does not support the requested operation.	Warning Critical	Drive Manager
SCSI Response ptr is NULL ptr	Drive did not return proper data to the requested command.	Critical	Drive Manager
SCSI unsupported response code	Drive does not support the requested command.	Critical	Drive Manager
Too many busy retries	The drive has responded with too may busy responses.	Warning	Drive Manager
Unknown protocol type	Drive communication protocol is not recognized.	Critical	Drive Manager
Malloc block failed	The system has run out of internal memory.	Critical	Drive Manager
Drive wait que error	The system has run out of internal memory.	Critical	Drive Manager
Sema error	The operating system has failed to create a resource.	Critical	Drive Manager
Sema put failed	The operating system has failed to create a resource.	Critical	Drive Manager
Could not activate event timer	The operating system has failed to create a timer resource.	Warning	Drive Manager
Could not activate util timer	The operating system has failed to create timer resource.	Warning	Drive Manager
Could not change event timer	The operating system has failed to modify a timer resource.	Warning	Drive Manager
Could not change util timer	The operating system has failed to modify a timer resource.	Warning	Drive Manager

Event Detail	Event Description	Category	Reported By
System reset by hardware (code/srr0)	Codes are: <ul style="list-style-type: none"> • CRITICAL 0x1111 • MACHINE_CHECK 0x2222 • ID_DATA_STORAGE 0x3333 • ISI_EXCEPTION 0x4444 • ALIGNMENT_EXCEPTION x5555 • PROGRAM_EXCEPTION x6666 • SYSTEM_CALL 0x7777FIT 0x8888 • WATCHDOG 0x9999 • INT_ID_DATA_TLB 0xA AAAA • INT_ID_INST_TLB 0xB BBBB • INT_ID_DEBUG 0xC CCCC • INT_ID_RESET • srr0 is always 0 	Critical	Event Manager
System reset by software (0/0)	System has been reset by the system software.	Critical	Event Manager
System reset by watchdog timer (0/0)	System has been reset by the internal watchdog timer.	Critical	Event Manager
System power failed (0/0)	System power has failed internal monitoring limits.	Critical	Event Manager
(re)Booted for unknown reason (post fail/sled:qsb)	An unexpected reboot has occurred.	Critical	Event Manager

Event Detail	Event Description	Category	Reported By
Rebooted by hardware trap (post fail/sled:qsb)	Serial Bus channel: <ul style="list-style-type: none"> • Drive Channel 89 - 0x00000200 • Drive Channel 67 - 0x00000100 • Drive Channel 45 - 0x00000080 • Drive Channel 23 - 0x00000040 • Drive Channel 01 - 0x00000020 • Front Panel - 0x00000010XYZ - 0x00000008 • Hand - 0x00000004 • Regulator Module - 0x00000002 • Backplane - 0x00000001 	Informational	Event Manager
Rebooted by software trap (post fail/sled:qsb)	An unexpected reboot has occurred.	Informational	Event Manager
Rebooted by CPU watchdog (post fail/sled:qsb)	An unexpected reboot has occurred.	Informational	Event Manager
Rebooted by code load (post fail/sled:qsb)	An unexpected reboot has occurred.	Informational	Event Manager
Powered on (post fail/sled:qsb)	An unexpected reboot has occurred.	Informational	Event Manager
Booted after power failed (post fail/sled:qsb)	An unexpected reboot has occurred.	Informational	Event Manager
User requested reboot (post fail/sled:qsb)	An unexpected reboot has occurred.	Informational	Event Manager

Event Detail	Event Description	Category	Reported By
Camera failed POST (event class/failure detail)	Event Classes: <ul style="list-style-type: none"> • Internal Firmware Failure 0x24 • Operating System Failure - 0x43 and 0x44 • Camera Init Failure 0x7C • Failure details are listed below. 	Critical	Image proc
Camera initialization failed (camera code)	Failure Codes: <ul style="list-style-type: none"> • Camera was reset, try again 0x0D • Write data doesn't match read data 0x0C • Counter doesn't match data mount 0x0B • Interrupt not received at 3/40 0x0A • Interrupt received too early 0x09 • Problem reading control regs 0x08 • Problem writing control regs 0x07 • I2C channel problem 0x06 • image data is truncated or missing 0x05 • Invalid image format 0x04 • Can't set camera's data window 0x03 • Firmware bug detected 0x02 • Camera is not operating or unrecognized 0x01 • No problems detected 0x00 	Critical	Image proc

Event Detail	Event Description	Category	Reported By
Camera was unexpectedly reset	The internal camera has been reset since the last time the system was powered on.	Warning	Image proc
Couldn't get mutex for camera I2C (thrdx status)	The operating system has failed to create a resource.	Warning	Image proc
Unknown status for OCP status LED (lib status)	The Front Panel hardware is in an unknown state.	Warning	OCP
Internal request to send null SCSI CDB	The operating system failed to create a proper SCSI command data block.	Critical	SCSI
Queue insert failed when receiving data out	The operating system has failed to create a resource for the SCSI module.	Critical	SCSI
SCB null in Release SCB	The information in the SCSI command is not present.	Critical	SCSI
SCB null when receiving data out	The information in the SCSI command is not present.	Critical	SCSI
SCB null	The information in the SCSI command is not present.	Critical	SCSI
Semaphore put failed when receiving data out	The operating system has failed to create a resource.	Critical	SCSI
Unexpected data out received	Data out was received from the host, but the SCSI server (the current SCB) was not in a state to receive the data.	Critical	SCSI
Unexpected data received	Data in was unexpectedly sent to the host	Critical	SCSI

Event Detail	Event Description	Category	Reported By
Unexpected response - no non-immed	A response to an outstanding non-immediate command was received and SCSI server did not know about the non-immediate command.	Critical	SCSI
Unexpected response - wrong state	A response to an outstanding non-immediate command was received and SCSI server did not know about the non-immediate command.	Critical	SCSI
No SCBs available	The operating system has failed to create a resource.	Critical	SCSI
Release failed in Release SCB	The operating system has failed to create a resource.	Critical	SCSI
Queue insert failed when receiving a SCSI command	The operating system has failed to create a resource.	Critical	SCSI
Queue insert failed	The operating system has failed to create a resource.	Critical	SCSI
Semaphore put failed when receiving a SCSI command	The operating system has failed to create a resource.	Critical	SCSI
Semaphore put failed	The operating system has failed to create a resource.	Critical	SCSI
Servo Initialization Failure	The system has failed to initialize the robotics.	Critical	Servo
Cartridge not in hand after get from magazine	The robotics did not detect a cartridge present when a tape was pulled from the magazine.	Warning	Servo
Servo Initialization Is Complete	The system has succeeded in initializing the robotics.	Informational	Servo

Event Detail	Event Description	Category	Reported By
Picker Axis Jammed	The portion of the robotics that picks the tape can not move is respective motor.	Warning	Servo
Picker Axis Position Lost	The portion of the robotics that picks the tape can not move its respective motor to the expected internal limits.	Warning	Servo
Picker Axis Retry	The portion of the robotics that picks the tape has exceeded internal retries.	Warning	Servo
Picker Axis Stalled	The portion of the robotics that picks the tape can not move its respective motor to the expected internal limits.	Warning	Servo
Picker Axis Timeout	The portion of the robotics that picks the tape could not position within its allotted time.	Warning	Servo
Theta Axis Jammed	The portion of the robotics that rotates can not move its respective motor.	Warning	Servo
Theta Axis Position Lost	The portion of the robotics that rotates can not move its respective motor to the expected internal limits.	Warning	Servo
Theta Axis Retry	The portion of the robotics that rotates theta has exceeded internal retries.	Warning	Servo
Theta Axis Stalled	The portion of the robotics that rotates can not move its respective motor to the expected internal limits.	Warning	Servo
Theta Axis Timeout	The portion of the robotics that rotates theta could not position within its allotted time.	Warning	Servo

Event Detail	Event Description	Category	Reported By
XY Axis Jammed	The portion of the robotics that moves the XY axis can not move its respective motor.	Warning	Servo
XY Axis Position Lost	The portion of the robotics that moves the XY axis can not move its respective motor to the expected internal limits.	Warning	Servo
XY Axis Retry	The portion of the robotics that moves XY has exceeded internal retries.	Warning	Servo
XY Axis Stalled	The portion of the robotics that moves the XY axis can not move its respective motor to the expected internal limits.	Warning	Servo
XY Axis Timeout	The portion of the robotics that moves XY could not position within its allotted time.	Warning	Servo
Z Axis Jammed	The portion of the robotics that positions Up and Down can not move its respective motor.	Warning	Servo
Z Axis Position Lost	The portion of the robotics that moves the Up/Down axis can not move its respective motor to the expected internal limits.	Warning	Servo
Z Axis Retry	The portion of the robotics that moves Up and Down has exceeded internal retries.	Warning	Servo
Z Axis Stalled	The portion of the robotics that moves the Up/Down axis can not move its respective motor to the expected internal limits.	Warning	Servo
Z Axis Timeout	The portion of the robotics that moves Up and Down could not position within its allotted time.	Warning	Servo

Event Detail	Event Description	Category	Reported By
Position to XYZ Failed	Robotics could not move to any axis position.	Warning	Servo
Failed to read NVM (status, region)	The robotics backplane has failed.	Critical	Sys manager
Failed to write NVM (status, region)	The robotics backplane has failed.	Critical	Sys manager
Init element structure failed	A firmware error has occurred.	Critical	Sys manager
Read from NV (backplane SPI) failed (status)	The robotics backplane has failed.	Warning	Sys manager
Could not convert GUI addr to physical (elem type/instance)	Bad element address.	Warning	Sys manager
Could not convert logical addr to physical (elem type/instance)	Bad element address.	Warning	Sys manager
Could not find drive element in partition (instance/part id)	Bad element address.	Warning	Sys manager
Could not find load port in cabinet (instance/cab index)	Bad element address.	Warning	Sys manager
Could not find load port in partition (instance/part id)	Bad element address.	Warning	Sys manager
Could not find storage element in cabinet (instance/cab index)	Bad element address.	Warning	Sys manager
Could not find storage element in partition (instance/part id)	Bad element address.	Warning	Sys manager

Event Detail	Event Description	Category	Reported By
Drv type from dmgr is not known (type)	A firmware error has occurred.	Critical	Sys manager
Failed to send response (status)	A firmware error has occurred.	Critical	Sys manager
Invalid element type in get SCSI Start Addr (type/sys Id)	Bad element address.	Warning	Sys manager
Invalid element type in get element count (type/sys Id)	Bad element address.	Warning	Sys manager
Receive async element status - invalid data type (type)	A firmware error has occurred.	Critical	Sys manager
Receive async element status - null element (type, index)	A firmware error has occurred.	Critical	Sys manager
SCSI Address does not convert to valid element type (addr/sys id)	Bad element address.	Informational	Sys manager
Sensor grp unknown (grp)	A firmware error has occurred.	Warning	Sys manager
Stack data received and no buffer to store it (cab index, offset)	A firmware error has occurred.	Warning	Sys manager
Stack message received unexpectedly (cab index, state)	A firmware error has occurred.	Warning	Sys manager
Unexpected response received (txid/sender)	A firmware error has occurred.	Informational	Sys manager
Unknown cleaning cartridge requested (drv elemType)	A firmware error has occurred.	Critical	Sys manager

Event Detail	Event Description	Category	Reported By
Cleaning tape not found (tape type)	An operation failed.	Warning	Sys manager
Cleaning tape not loaded for clean op (drvNum)	An operation failed.	Critical	Sys manager
Drive cleaning operation failed (drvNum, status)	An operation failed.	Critical	Sys manager
Stack message received while one in progress (cab index, offset)	A stack communication error has occurred.	Informational	Sys manager
Allocate failed (threadX status/pool)	A TX blk pool op error has occurred.	Critical	Sys manager
Create data pool failed (threadX status)	A TX blk pool op error has occurred.	Critical	Sys manager
Create elem pool failed (threadX status)	A TX blk pool op error has occurred.	Critical	Sys manager
Create label pool failed (threadX status)	A TX blk pool op error has occurred.	Critical	Sys manager
Release failed (threadX status)	A TX blk pool op error has occurred.	Critical	Sys manager
Create failed (threadX status/que)	A TX blk queue op error has occurred.	Critical	Sys manager
Receive failed (threadX status)	A TX blk queue op error has occurred.	Critical	Sys manager
Send failed (msgid/threadX status)	A TX blk queue op error has occurred.	Critical	Sys manager
Create failed (threadX status)	A TX blk semaphore op error has occurred.	Critical	Sys manager
Create failed (threadX status)	A TX blk timer op error has occurred.	Critical	Sys manager
Shutdown timer expired (task mask)	Time limit has expired.	Informational	Sys manager

Event Detail	Event Description	Category	Reported By
Fan speed critical(0,id) Fan speed warning(0,id)	Fan monitoring <ul style="list-style-type: none"> • id Blake 0 B1 B2 B3 " PSU0" • 1 B1 B2 B3 " PSU1" • 2 B2 B3 " PSU2" • 3 B2 B3 " PSU3" • 4 B3 " PSU4" • 5 B3 " PSU5" • 6 B1 B2 B3 "Sled0" • 7 B1 B2 B3 "Sled1" • 8 B2 B3 "Sled2" • 9 B2 B3 "Sled3" • 10 B2 B3 "Sled4" • 11 B2 B3 "Sled5" • 12 B3 "Sled6" • 13 B3 "Sled7" • 14 B3 "Sled8" • 15 B3 "Sled9" • 16 B2 B3 "CPCI0" • 17 B2 B3 "CPCI1" 	Critical	Sys monitor
FPGA program failed	The FPGA has failed.	Critical	Sys monitor
Unexpected error returned from smgrEventDriveInserted (index,status)	A firmware error has occurred.	Critical	Sys monitor
Unexpected error returned from smgrEventDriveRemove d(index,status)	A firmware error has occurred.	Critical	Sys monitor

Event Detail	Event Description	Category	Reported By
Unexpected error returned from smgrEventDriveSensorChange-QSB(index,status)	A firmware error has occurred.	Critical	Sys monitor
Unexpected error returned from smgrEventDriveSensorChange-power(index,status)	A firmware error has occurred.	Critical	Sys monitor
Unexpected error returned from smgrEventDriveSensorChange-power(index,status)	A firmware error has occurred.	Critical	Sys monitor
Unexpected error returned from smgrEventDriveSensorChange-temp(0,status)	A firmware error has occurred.	Critical	Sys monitor
Unexpected error returned from smgrEventPowerSupplySensorChange(index,status)	A firmware error has occurred.	Critical	Sys monitor
Unexpected error returned from smgrEventSensorChange-QSB(0,status)	A firmware error has occurred.	Critical	Sys monitor
Unexpected error returned from smgrEventSensorChange-adc(0,status)	A firmware error has occurred.	Critical	Sys monitor
Unexpected error returned from smgrEventSensorChange-doors(0,status)	A firmware error has occurred.	Critical	Sys monitor

Event Detail	Event Description	Category	Reported By
Unexpected error returned from smgrEventSensorChange-temp(0,status)	A firmware error has occurred.	Critical	Sys monitor
Unexpected error returned from smgrEventVarries-fans(0,status)	A firmware error has occurred.	Critical	Sys monitor
MAC Address is Zero(index/index)	MAC address is not set.	Critical	Sys monitor
Drive Sled Inserted(sled/0)	Normal operation	Informational	Sys monitor
Drive Sled Removed(sled/0)	Normal operation	Informational	Sys monitor
Power Supply Inserted (supply/0)	Normal operation	Informational	Sys monitor
Power Supply Removed (supply/0)	Normal operation	Informational	Sys monitor
System Time Base Set(msecs/seconds)	Normal operation	Informational	Sys monitor
System booted(build type/version)	Normal operation	Informational	Sys monitor

Event Detail	Event Description	Category	Reported By
<p>Monitored power level critical(0,id)</p> <p>Monitored power level warning(0,id)</p>	<p>Power monitoring</p> <p>channel 0-1id Blake Units</p> <p>0 B2 B3 VOLTS "3.3v cpci_A"</p> <p>1 B2 B3 VOLTS "5.0v cpci_A"</p> <p>2 B2 B3 VOLTS "24v cpci_A"</p> <p>3 B2 B3 VOLTS "24v cpci_B"</p> <p>4 B3 VOLTS "24v cpci_C"</p> <p>5 B2 B3 VOLTS "3.3v cpci_B"</p> <p>6 B2 B3 VOLTS "5.0v cpci_B"</p> <p>7 B3 VOLTS "3.3v cpci_C"</p> <p>8 B3 VOLTS "5.0v cpci_C"</p> <p>9 B2 B3 VOLTS "12v cpci"</p> <p>10 B1 B2 B3 AMPS "24v buss_A current"</p> <p>11 B1 B2 B3 VOLTS "3.3v scb"</p> <p>12 B1 B2 B3 VOLTS "2.5v scb"</p> <p>13 B1 B2 B3 VOLTS "1.8v scb"</p> <p>14 B1 B2 B3 VOLTS "1.2v scb"</p> <p>15 B1 B2 B3 PSID "psu0 ID"</p> <p>16 B1 B2 B3 PSID "psu1 ID"</p> <p>17 B1 B2 B3 VOLTS "psu0 24v"</p> <p>18 B1 B2 B3 VOLTS "psu1 24v"</p> <p>19 B1 VOLTS "12v cpci"</p> <p>20 B2 B3 VOLTS "24v scb"</p> <p>21 B1 VOLTS "5.0v scb/cpci"</p> <p>22 B2 B3 AMPS "24v buss_B current"</p> <p>23 B2 B3 PSID "psu2 ID"</p> <p>24 B2 B3 PSID "psu3 ID"</p> <p>25 B2 B3 VOLTS "psu2 24v"</p> <p>26 B2 B3 VOLTS "psu3 24v"</p> <p>27 B2 B3 VOLTS "5.0v scb"</p> <p>28 B3 AMPS "24v buss_C current"</p> <p>29 B3 PSID "psu4 ID"</p> <p>30 B3 PSID "psu5 ID"</p> <p>31 B3 VOLTS "psu4 24v"</p> <p>32 B3 VOLTS "psu5 24v"</p>	<p>Warning</p> <p>Critical</p>	<p>Sys monitor</p>
	<p>Power monitoring</p>		<p>Sys monitor</p>
<p>QSB Channel Errors (channel/errors)</p>	<p>A QSB error has occurred.</p>	<p>Warning</p>	<p>Sys monitor</p>
<p>QSB Channel Failure (channel/count)</p>	<p>A QSB failure has occurred.</p>	<p>Critical</p>	<p>Sys monitor</p>

Event Detail	Event Description	Category	Reported By
QSB Channel Resyncs (channel/resyncs)	A QSB resync has occurred.	Warning	Sys monitor
RTC Failure	The real time clock has failed.	Critical	Sys monitor
RTC Time not set	The real time clock has not been set.	Informational	Sys monitor
Unknown board revision(board/ Board Revision)	An unknown board revision has been detected.	Critical	Sys monitor
Wrong CPLD revision(board/CPLD Revision)	Wrong CPLD revision detected.	Critical	Sys monitor
ADC Sensor Communication Failed(channel/id)	The SPI flash has failed. <ul style="list-style-type: none"> • channel 0-1id • 2 SPI_ID_BP_ADC_1 • 3 SPI_ID_BP_ADC_2 • 14 SPI_ID_BRM_ADC 	Critical	Sys monitor
BP is over temperature(old temp/ new temp)	The backplane has experienced an over-temp condition.	Critical	Sys monitor
BRM is over temperature(old temp/ new temp)	The BRM has experienced an over-temp condition.	Critical	Sys monitor
BRM1 is over temperature(old temp/ new temp)	The BRM1 has experienced an over-temp condition.	Critical	Sys monitor
BRM2 is over temperature(old temp/ new temp)	The BRM2 has experienced an over-temp condition.	Critical	Sys monitor
BRM3 is over temperature(old temp/ new temp)	The BRM3 has experienced an over-temp condition.	Critical	Sys monitor

Event Detail	Event Description	Category	Reported By
OCP is over temperature(old temp/new temp)	The OCP has experienced an over-temp condition.	Critical	Sys monitor
HAND is over temperature(old temp/new temp)	The hand has experienced an over-temp condition.	Critical	Sys monitor
SCB is over temperature(old temp/new temp)	The system controller board has experienced an over-temp condition.	Critical	Sys monitor
SLED0 is over temperature(old temp/new temp)	Sled 0 has experienced an over-temp condition.	Critical	Sys monitor
SLED1 is over temperature(old temp/new temp)	Sled 1 has experienced an over-temp condition.	Critical	Sys monitor
SLED2 is over temperature(old temp/new temp)	Sled 2 has experienced an over-temp condition.	Critical	Sys monitor
SLED3 is over temperature(old temp/new temp)	Sled 3 has experienced an over-temp condition.	Critical	Sys monitor
SLED4 is over temperature(old temp/new temp)	Sled 4 has experienced an over-temp condition.	Critical	Sys monitor
SLED5 is over temperature(old temp/new temp)	Sled 5 has experienced an over-temp condition.	Critical	Sys monitor
SLED6 is over temperature(old temp/new temp)	Sled 6 has experienced an over-temp condition.	Critical	Sys monitor
SLED7 is over temperature(old temp/new temp)	Sled 7 has experienced an over-temp condition.	Critical	Sys monitor

Event Detail	Event Description	Category	Reported By
SLED8 is over temperature(old temp/new temp)	Sled 8 has experienced an over-temp condition.	Critical	Sys monitor
SLED9 is over temperature(old temp/new temp)	Sled 9 has experienced an over-temp condition.	Critical	Sys monitor
Temp Sensor Communication Failed(channel/iic_id)	<p>A temperature sensor has failed.</p> <ul style="list-style-type: none"> • channel 0-9id • 17 IIC_ID_TEMP_SCB • 18 IIC_ID_TEMP_BP • 19 IIC_ID_TEMP_BRM • 20 IIC_ID_TEMP_BRM1 • 21 IIC_ID_TEMP_BRM2 • 22 IIC_ID_TEMP_BRM3 • 23 IIC_ID_TEMP_HAND • 24 IIC_ID_TEMP_XY • 25 IIC_ID_TEMP_Z • 26 IIC_ID_TEMP_GUI • 27 IIC_ID_TEMP_SLED0 • 28 IIC_ID_TEMP_SLED1 • 29 IIC_ID_TEMP_SLED2 • 30 IIC_ID_TEMP_SLED3 • 31 IIC_ID_TEMP_SLED4 • 32 IIC_ID_TEMP_SLED5 • 33 IIC_ID_TEMP_SLED6 • 34 IIC_ID_TEMP_SLED7 • 35 IIC_ID_TEMP_SLED8 • 36 IIC_ID_TEMP_SLED9 	Critical	Sys monitor

Event Detail	Event Description	Category	Reported By
XY is over temperature(old temp/new temp)	The XY axis motor has experienced an over-temp condition.	Critical	Sys monitor
Z is over temperature(old temp/new temp)	The Z axis motor has experienced an over-temp condition	Critical	Sys monitor

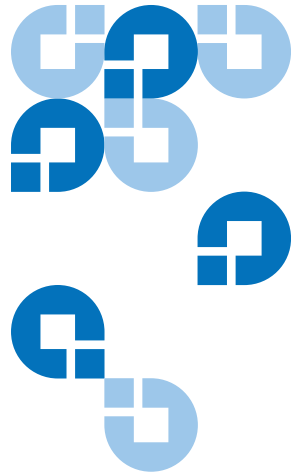

Chapter 5 Troubleshooting

This chapter describes problems you may encounter during the setup and operation of the Quantum Scalar 50 library. Corrective information is provided to help you resolve the problems.

Several of these problems produce error messages on the OCP called events (refer to [chapter 4](#)).

This chapter is divided into the following sections:

- [Common Problems and Solutions](#)
- [Interpreting System LED Status](#)

Common Problems and Solutions

The troubleshooting information in this section covers the following topics:

- [Start-up Problems](#)
- [OCP Problems](#)
- [Robotics \(Hand\) Problems](#)
- [Operating Problems](#)

Start-up Problems

[Table 31](#) describes corrective actions for problems which occur during start-up.

Table 31 Start-up Problems

Problem	Corrective Action
The library does not power on.	<ul style="list-style-type: none"> • Make sure all power cords are connected to grounded electrical outlet. • Press the power button located on the front of the library.
The library or tape drives do not respond on the SCSI bus.	Make sure each SCSI device on the same SCSI bus has a unique address and the last device is properly terminated.
During initialization, the OCP displays "ERR." in the upper right hand corner and the LED located under the buttons is amber.	<ul style="list-style-type: none"> • Power the system down completely and power it back on. • Determine the failure type by checking any previous error codes returned to the host computer. • Check the event logs from the remote management pages (see chapter 3 on page 63).
One or more tape drives fails to power up,	<ul style="list-style-type: none"> • Power on tape drives from the OCP. • Remove and reinstall the tape drive.
The tape drives are not visible from the host system.	<ul style="list-style-type: none"> • Check all SCSI cabling and termination at the back of the library. If necessary, contact your field service representative about replacing the drives. • Power on tape drives from the OCP. • Remove and reinstall the tape drive.

OCP Problems

[Table 32](#) describes corrective actions for OCP problems.

Table 32 OCP Problems

Problem	Corrective Action
The OCP is blank.	<ul style="list-style-type: none"> Physically remove the AC power by removing all power cords from the power supply(s) and reconnect them. Confirm that power is on and if the OCP is still blank, contact an authorized Quantum field service engineer (see “Contacts” on page xx).
The OCP does not respond to buttons.	<ul style="list-style-type: none"> Verify that the buttons are not stuck underneath the front bezel. Physically remove the AC power by removing all power cords from the power supply(s) and reconnect them. Power the library on and if the OCP still does not respond to buttons, contact an authorized Quantum field service engineer (see “Contacts” on page xx).
An error number or event is displayed.	Write down the error number and contact an authorized Quantum field service engineer (see “Contacts” on page xx).

Robotics (Hand) Problems

[Table 33](#) describes corrective actions for robotics or hand problems.

Table 33 Robotics (Hand)
Problems

Problem	Corrective Action
<p>The robot does not move at power up.</p>	<ul style="list-style-type: none"> • Make sure that all internal packing materials (foam pads and metal straps) have been removed. • Check the library state on the OCP or remote management pages. If Door Open is displayed, make sure the front doors are closed. • Physically remove the AC power by removing all power cords from the power supply(s) and reconnect them. Power the library on and if the robot still does not move, contact an authorized Quantum field service engineer (see “Contacts” on page xx).
<p>The barcode reader cannot read the barcode and displays “no label”.</p>	<ul style="list-style-type: none"> • Verify that nothing obstructs the reader. • It is recommended to avoid barcode reader problems, to only use tape cartridge labels provided by manufacturer. • Reboot the library (see “Reboot Library” on page 126). If the problem continues, contact an authorized Quantum field service engineer see “Contacts” on page xx).
<p>The robot times out or fails during an operation.</p>	<ul style="list-style-type: none"> • Check that the tape cartridge involved in the operation is properly positioned in the slot or drive and ready to be picked. • Check that the robot is not obstructed in any way. • Retry the operation. If it still fails, contact a field service engineer.

Problem	Corrective Action
The robot drops a cartridge.	<ul style="list-style-type: none"> • Open the doors. • Retrieve the cartridge, orient it properly, and place the cartridge in an empty storage slot. (Do not try to place the cartridge in the hand.) • Perform an inventory (see “Inventory Page” on page 82). • If the operator manually places a cartridge in an empty slot, he must then run an inventory so the library records the position of the manually placed cartridge.

Operating Problems

[Table 34](#) describes the corrective action for problems which occur during library operation.

Table 34 Problems During Library Operation

Problem	Corrective Action
The host computer cannot communicate with the library.	<p>This may be a SCSI bus time-out or a premature disconnect problem.</p> <p>Check cable connections, cable length, SCSI addresses, and termination.</p> <p>Restart the host and the library ensuring that the library is “on-line” before the host is restarted.</p> <p>If the host and library still are not communicating, contact an authorized Quantum field service engineer see (“Contacts” on page xx).</p>

Problem	Corrective Action
<p>A tape cartridge (medium) is reported not present.</p>	<p>This indicates that the hand could not sense a tape cartridge in a particular storage slot even though the inventory reports that it is present.</p> <p>The system performs optimally when tape cartridge labels are present.</p> <p>Check to see if the designated cartridge is present. If it is, make sure it is properly seated. (For a tape drive, make sure the cartridge is completely unloaded.) Then retry the command.</p> <p>If the error persists, contact an authorized Quantum field service engineer see (“Contacts” on page xx).</p>
<p>A move command failed.</p>	<p>Check the source and destination slots. The source slot should hold the cartridge to be moved; the destination slot should be empty.</p> <p>Make sure the hand is empty and all actuators are free of obstruction.</p> <p>Retry the command.</p> <p>Reboot the library (see “Reboot Library” on page 126). If the problem continues, contact an authorized Quantum field service engineer see “Contacts” on page xx).</p>
<p>A flash memory error is reported.</p>	<p>Contact an authorized Quantum field service engineer.</p>
<p>A maximum temperature exceeded warning is displayed.</p>	<p>Turn off the library and allow it to cool down. Lower the room temperature, if possible, and increase ventilation around the library.</p> <p>(If the operating temperature is too high, the library will automatically shut down until the temperature drops.)</p>

Problem	Corrective Action
Cleaning cartridge marked as unrecognized media	Ensure that the cleaning cartridge has the correct barcode label. You must use the correct label for the cartridge type.
The remote management pages report the following event: surrogate drive logged out	From the OCP, power the tape drive off and then back on. If the drive is still logged out, contact Quantum Technical Support " Contacts " on page xx.
The remote management pages report the following event: surrogate drive communication lost	From the OCP, power the tape drive off and then back on. If drive communication is still lost, contact Quantum Technical Support " Contacts " on page xx.
The remote management pages report the following event: surrogate drive unavailable - power lost or canister removed	Check to see if the tape drive is installed. If the drive is installed, reseal the tape drive by removing and reinstalling the drive. If the library still indicates that the power is lost or canister removed, contact Quantum Technical Support " Contacts " on page xx.

Interpreting System LED Status

The following system LED status indicators are available on the Scalar 50 libraries:

- [Operator Control Panel \(OCP\) LED Status](#)
- [System Controller Board \(SCB\) LED Status](#)

- [Power Supply LED Status](#)
- [Tape Drive LED Status](#)

Operator Control Panel (OCP) LED Status

Table 35 OCP LED States

The OCP has an LED indicator reporting the library state (see [table 35](#)).

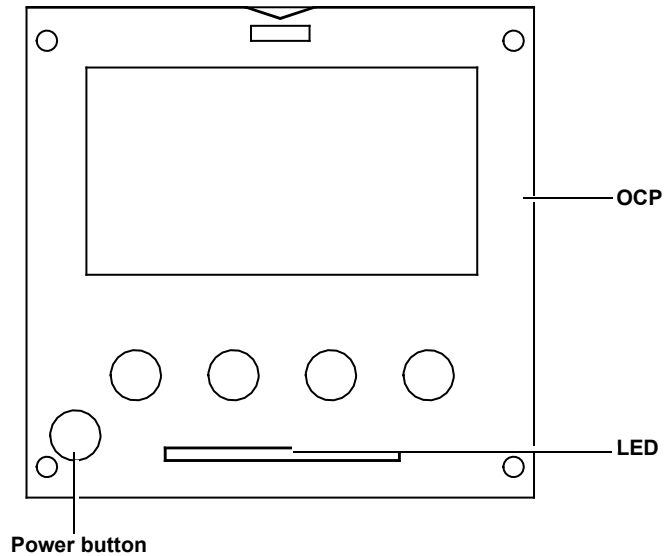

LED Status	Problem/Status
Green solid	The library is in an idle state.
Green flashing	The library is busy.
Amber flashing	The library is in an attention state.
Amber solid	An error has occurred on the library.

System Controller Board (SCB) LED Status

The SCB contains LED indicators that reports the state of the SCB and Fibre Channel port (see [table 36](#), [table 37](#), and [table 38](#)).

Table 36 SCSI SCB LED

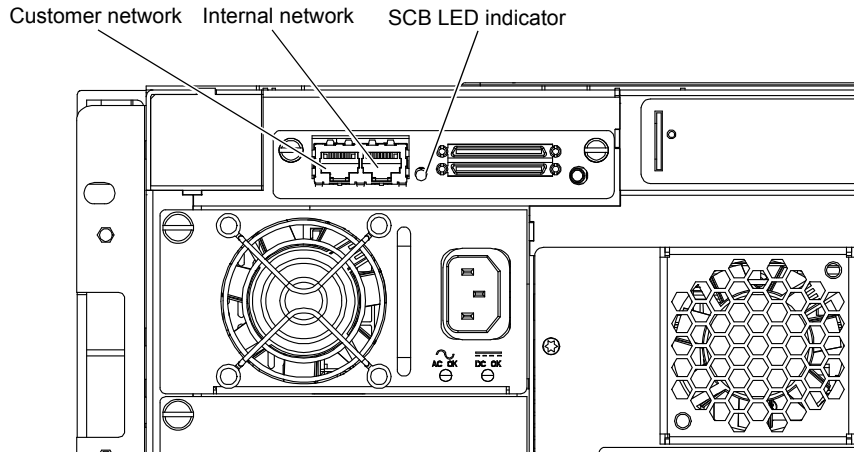

LED Status	Problem/Status
SCB LED Flashing	SCB good. Communicating.
SCB LED solid	<ul style="list-style-type: none"> • System busy. • If the LED is solid for more than two minutes and the library has been initialized, contact an authorized Quantum field service engineer see ("Contacts" on page xx).
SCB LED Off	<ul style="list-style-type: none"> • System idle. • If the LED is off for more than two minutes and the library has been initialized, contact an authorized Quantum field service engineer see ("Contacts" on page xx).

Table 37 Surrogate SCB LED

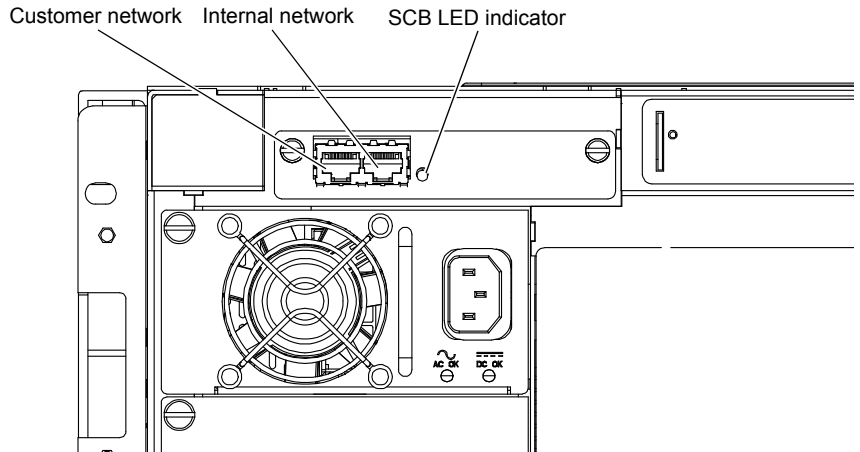

LED Status	Problem/Status
SCB LED Flashing	SCB good. Communicating.
SCB LED solid	<ul style="list-style-type: none"> • System busy. • If the LED is solid for more than two minutes and the library has been initialized, contact an authorized Quantum field service engineer see ("Contacts" on page xx).
SCB LED Off	<ul style="list-style-type: none"> • System idle. • If the LED is off for more than two minutes and the library has been initialized, contact an authorized Quantum field service engineer see ("Contacts" on page xx).

Table 38 Fibre Channel SCB LED

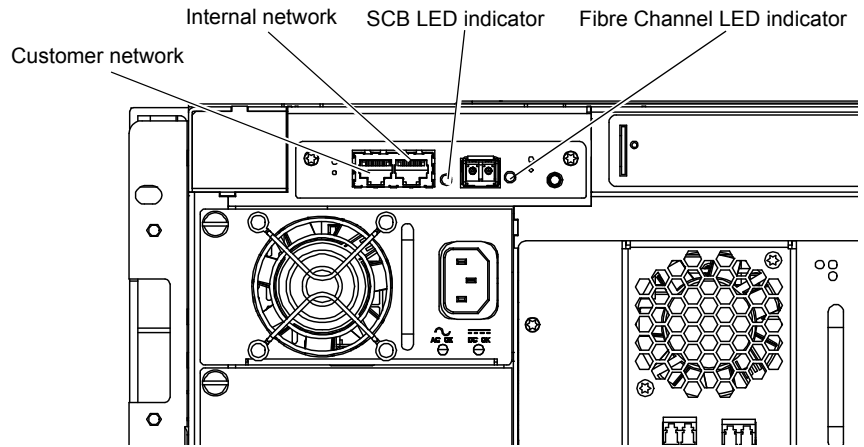

LED Status	Problem/Status
SCB LED Flashing	SCB good. Communicating.
SCB LED solid	<ul style="list-style-type: none"> • System busy. • If the LED is solid for more than two minutes and the library has been initialized, contact an authorized Quantum field service engineer see ("Contacts" on page xx).
SCB LED Off	<ul style="list-style-type: none"> • System idle. • If the LED is off for more than two minutes and the library has been initialized, contact an authorized Quantum field service engineer see ("Contacts" on page xx).
Fibre Channel LED solid	<ul style="list-style-type: none"> • Fibre Channel port has a good link.
Fibre Channel LED Off	<ul style="list-style-type: none"> • Fibre Channel port is unplugged or does not have a good link.

Power Supply LED Status

The power supplies have an LED indicator reporting the power supply state (see [table 39](#)).

Table 39 Power Supply LEDs

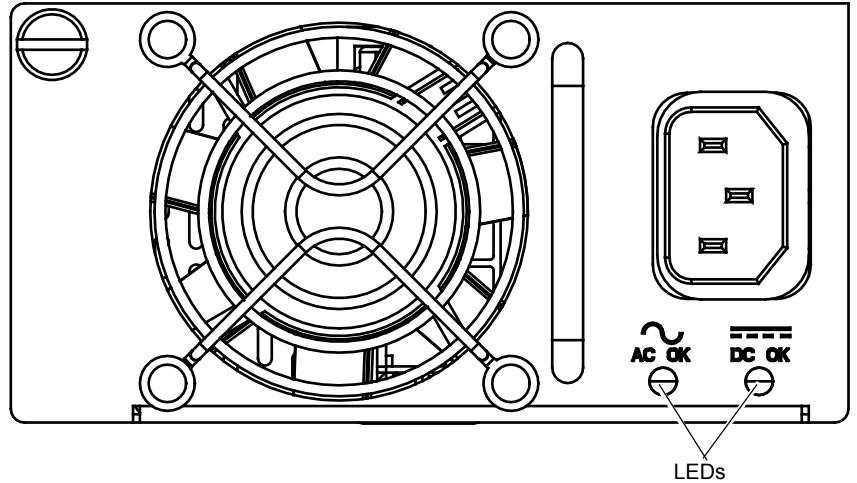

LED Status	Problem/Status
AC OK solid green	Power has been applied to the power supply and is within specifications.
AC OK off	The power supply is not attached to a power source or the power source has failed.
DC OK solid green	The power supply is providing DC power to the library normally.
DC OK off	The power supply has failed.

Tape Drive LED Status

The tape drive canisters have LED indicators reporting the tape drive state (see [table 40](#)).

Table 40 Tape Drive LEDs

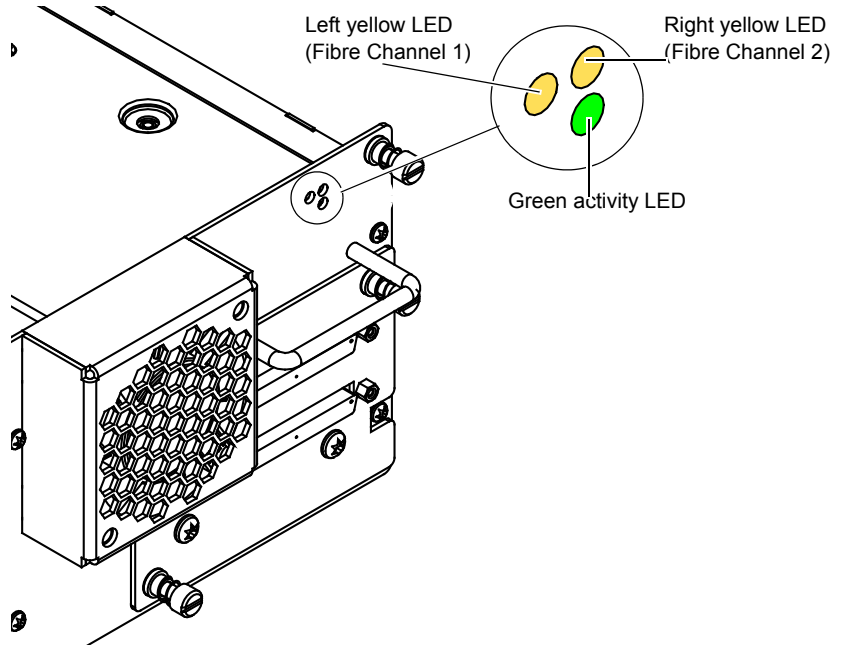

LED Status	Problem/Status
Green flashing	Drive good. Communicating.
Green solid	Drive failed
Off	No power to drive.
Left yellow on	Fibre Channel port active.
Right yellow on	Fibre Channel port active.

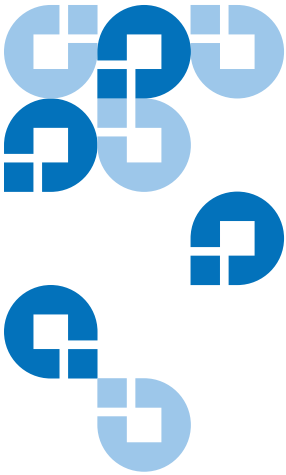

Appendix A Specifications

This appendix lists the following specifications for the Scalar 50 libraries:

- [Physical Specifications](#)
- [Performance Specifications](#)
- [Reliability Specifications](#)
- [Tape Drive Specifications](#)
- [Environmental Specifications](#)
- [SCSI Specifications](#)

Physical Specifications

Table 41 Unit Dimensions/
Weight

Scalar 50	
Width	19 in. (482 mm)
Depth	31 in. (762 mm.)
Height	6.75 in. (171 mm)
Weight	87 lbs. (39 kg) with 2 drives, 2 magazines, and 0 cartridges installed

Table 42 Capacities

Scalar 50	
Number of Tape Drives	Up to 2
Type of Tape Drives	DLT-S4 (SCSI and nFC), HP and Quantum LTO Gen 3, HP LTO Gen 4 (SCSI and nFC)
Number of Tape Cartridges	Up to 32 SDLT tape cartridges Up to 38 LTO cartridges
Type of Tape Cartridges	For use with: <ul style="list-style-type: none"> • DLT-S4 drives: DLT-S4 media • HP LTO Gen drives: HP and Quantum LTO-3 and HP LTO-4 Ultrium cartridges
Number of Magazines	Up to 2
Magazine Capacity	Each magazine holds up to 15 SDLT tape cartridges or up to 18 LTO tape cartridges
Manual Access Facility	Yes

Scalar 50	
Robot Mounted Bar Code Reader	Yes
Scalability	Yes

Performance Specifications

Table 43 Performance Specifications

Scalar 50	
Average Swap Time	Less than 14 seconds

Table 44 Library Performance

	Tape Drive	Data Capacity (Excluding Fixed Slots)*	Maximum Data Capacity (Including Fixed Slots)*	Maximum Data Throughput*	Host Interfaces
Scalar 50 (2 drives)	DLT-S4	48 TB	51.2 TB	864 GB/hr	Ultra 320 SCSI and Native Fibre Channel
	Quantum LTO Gen 3	28.8 TB	30.4 TB	490 GB/hr	LVD Ultra 3 SCSI and Native Fibre Channel
	HP LTO Gen 3	28.8 TB	30.4 TB	1.1 TB/hr	LVD Ultra 3 SCSI and Native Fibre Channel
	HP LTO Gen 4	57.6	60.8	1.7	LVD Ultra 3 SCSI, SAS, and Native Fibre Channel

* Assuming 2:1 compression ratios

Reliability Specifications

Table 45 Reliability Specifications

MSBF	Scalar 50 = 1,000,000 swaps
MTTR	Less than 30 minutes

Tape Drive Specifications

Table 46 Tape Drive Specifications

Drive Type	Native Mode		With 2:1 Compression	
	Transfer Rate	Capacity	Transfer Rate	Capacity
DLT-S4	3600 MB/min	800 GB	7200 MB/min	1600 GB
HP LTO Gen 3	4800 MB/min.	400 GB.	9600 MB/min.	800 GB
HP LTO Gen 4	4800 MB/min.	800 GB.	12000 MB/min.	1.6 TB

Environmental Specifications

Table 47 Power

Scalar 50		
Electrical Input Tolerances	Voltage	90-264 VAC, 47-63 Hz
	Power	300W (average)

Table 48 Climate

	Temperature (Operating)	Temperature (Non-Operating)
Temperature	+50°F to 95°F (+10°C to +35°C)	-40°F to +149°F (-40°C to +65°C)
Humidity	20% to 80% non-condensing	10% to 90% non-condensing
Altitude	-500 to +10,000 feet (-152 to +3,048 meters)	-500 to +40,000 feet (-152 to +12,192 meters)

Noise Levels

The work area noise generated by the library amounts to 57.4 dB(A).

Deutsch: Die arbeitsplatzbezogene Geräuschemission des Gerätes beträgt 57.dB(A).

SCSI Specifications

LVD SCSI configurations have a maximum allowable bus length of 12 meters (39 feet). To determine the cable length of the bus, measure the lengths of the SCSI cables connecting each device to that bus and add those lengths together. To that total length, add 12.25 inches (31.10 cm) for the internal SCSI cable length of each SCSI tape drive.

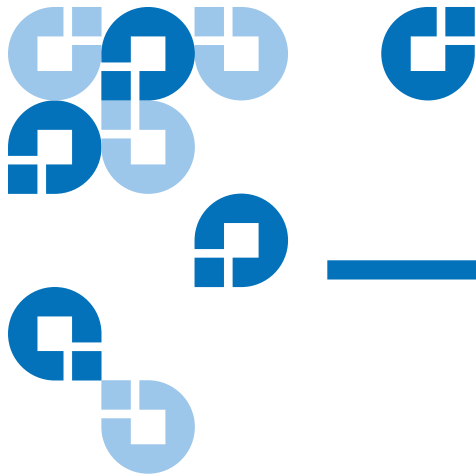

Appendix B

SDLTtape Cartridge Maintenance

This appendix provides guidelines for handling SDLT cartridges and visually inspecting cartridges if necessary.

Handling DLTtape Cartridges

- Always keep each tape cartridge in its protective plastic case when it is not in the library.
- When carrying tape cartridges in their cases, always orient the cases so that the grooves in the cases interlock. This prevents the cases from slipping apart and falling.
- Never stack more than five cartridges on top of each other.
- Always observe the proper environmental conditions for the storage of tape cartridges. Refer to the cartridge reference card supplied with each cartridge.
- When placing tape cartridges in archival storage, make sure you stand each tape cartridge vertically.
- Avoid placing tape cartridges near any sources of high intensity magnetic fields, such as computer monitors or electric motors.

- Never apply adhesive labels or POST-IT notes to the top, side, or bottom of your DLTtape cartridge. Only use the user slide-in type label provided with each cartridge and slide it over the label slot on the cartridge.
- Do not carry cartridges loosely in a box or any other container. Allowing cartridges to bang together exposes them to unnecessary physical shock.
- Do not touch or allow direct contact with tape or tape leader. Dust or natural skin oils can contaminate the tape and impact tape performance.
- Do not expose the tape cartridge to moisture or direct sunlight.
- Do not insert a dropped or damaged cartridge into a DLTtape drive without, at the very least, a thorough visual inspection (see [Visual Inspection of DLTtape Cartridges](#)). A dropped cartridge may have dislodged, loosened, or damaged internal components.

Visual Inspection of DLTtape Cartridges

When To Visually Inspect a DLTtape Cartridge

It is important to visually inspect a DLTtape cartridge under the following circumstances:

- Whenever you change or load a new tape cartridge
- If the tape cartridge has been dropped or subjected to a physical shock
- If a DLTtape drive becomes inoperable after loading the tape cartridge
- If you receive a shipment of tape cartridges that shows any sign of being damaged

Visual Inspection Procedure

To visually inspect a DLTtape cartridge:

- 1 Check the cartridge for any obvious cracks or other physical damage.

- 2 Gently shake the tape cartridge. Listen for any rattling of loose pieces inside the cartridge.

Caution: If you hear anything loose inside the cartridge, do not use the cartridge.

- 3 Locate the reel lock openings (see [figure 99](#)) and verify that you can see the reel locks.

The reel locks are small plastic tabs near the center of the reel lock openings. They can be broken if the cartridge is dropped.

Caution: If the reel locks are not visible, do not use the cartridge.

Figure 99 Location of the Reel Locks and the Hub

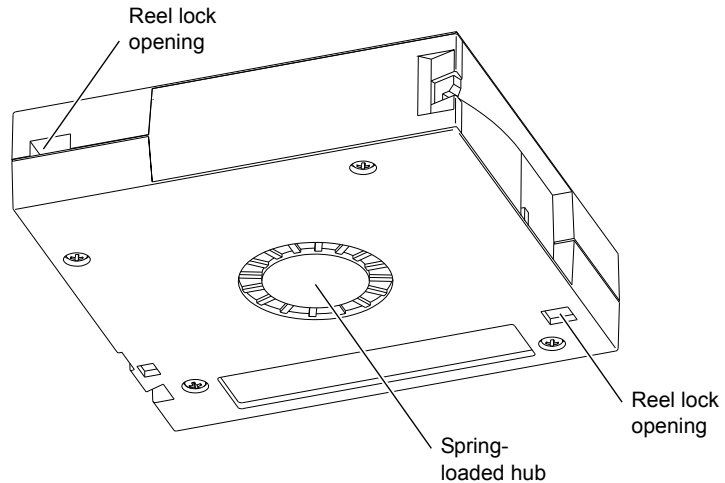

- 4 Verify that the spring-loaded hub (see [figure 99](#)) is centered within the circular opening in the tape cartridge.
- 5 Gently press the hub, then release it. Make sure the hub springs back into place and is still centered within its circular opening.
- 6 Open the tape cartridge door (see [figure 100](#)):
 - a Gently press up on the tab at the right side of the tape cartridge door.
 - b Swing the door open.

Figure 100 Opening the Tape Cartridge Door

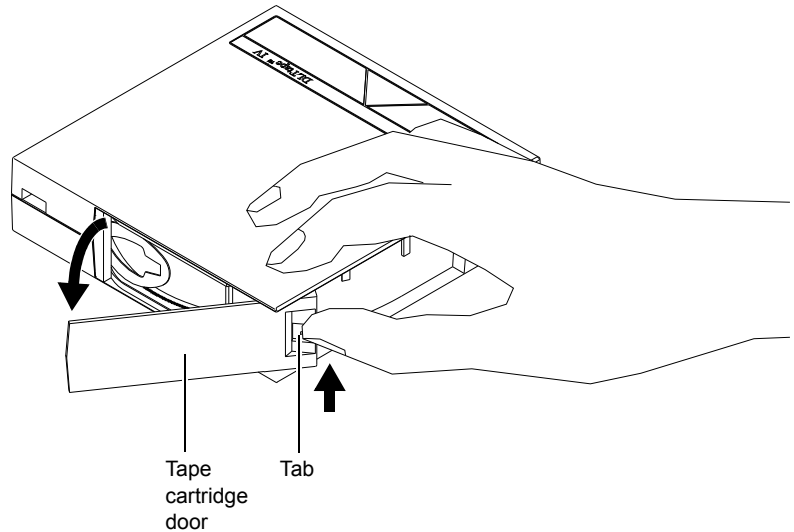

7 Verify that:

- The tape is wound tightly on the reel
- The tape leader loop is sticking up about an eighth of an inch
- The tape leader loop is not bent or torn

Caution: If any of the above conditions are not met, do not use the cartridge.

8 Check for proper operation of the tape cartridge's write-protect switch (see [figure 101](#)).

The switch should snap back and forth, and the orange tab should be visible when the switch is in the write-protected position.

Figure 101 Write Protect
Switch

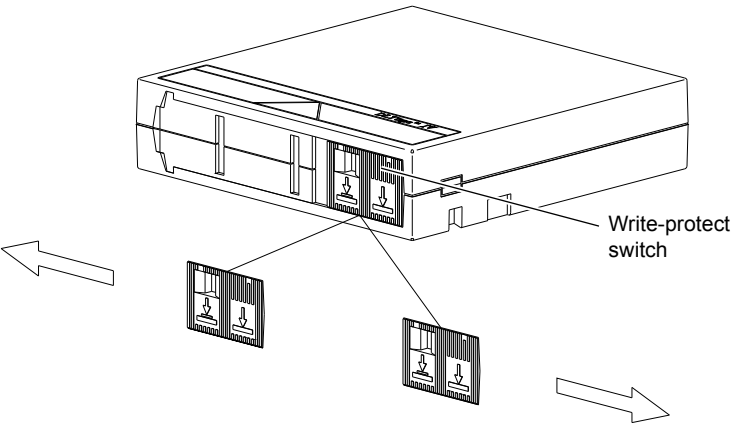

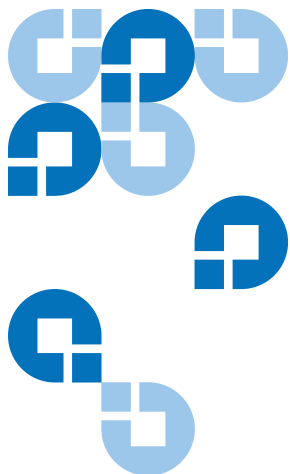

Appendix C

Installing the Scalar 50 Library

This appendix explains how to install the Quantum Scalar 50 library.

Selecting an Installation Location

When choosing an installation site for the Scalar 50 library, consider the following requirements:

- [Rack Space Requirements](#)
- [Environmental Conditions](#)

Rack Space Requirements

[Figure 102](#) shows the minimum rack space required by the Scalar 50 library.

- Depth - 31 in (76.2 cm)
- Width - 19 in (48.3 cm)
- Height - 6.75 in (17 cm)
- Weight - 52 lbs (23.6 kg)
- Clearance behind library - 4 in (10 cm) behind unit for proper air flow

Figure 102 Rack Space Requirements

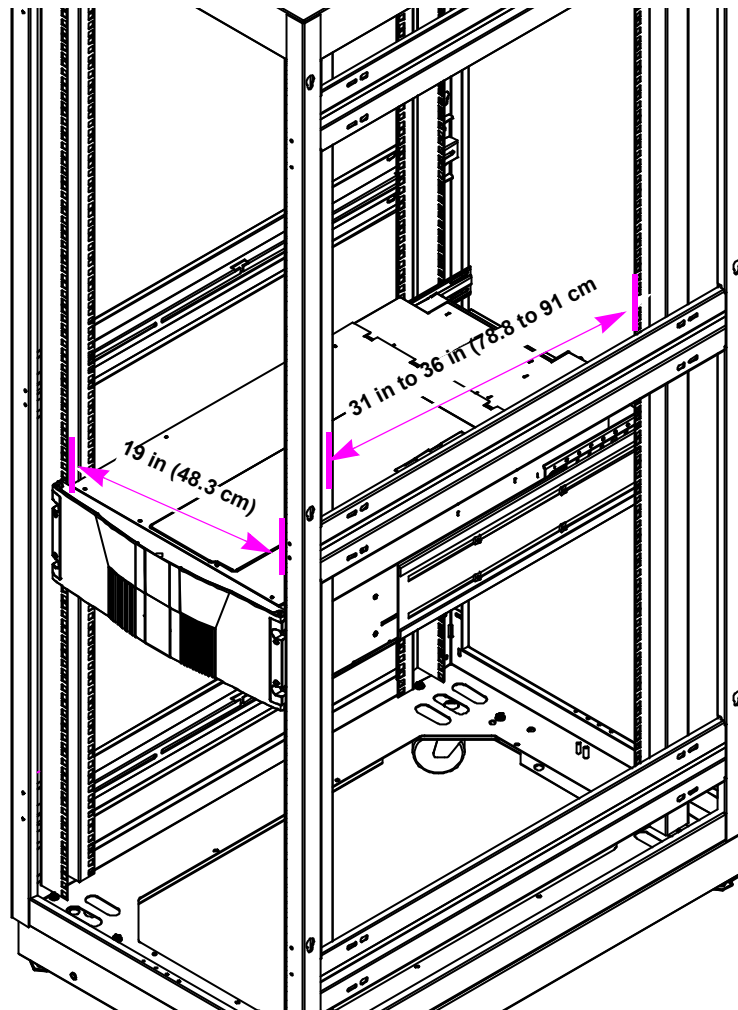

Environmental Conditions

Refer to [appendix A](#) on page 177 for environmental condition information.

Preparing for the Installation

Before you begin the installation procedure in this section, make the following preparations as described in this section:

- [Providing Necessary Tools and Equipment](#)
- [Taking ESD Precautions](#)

Providing Necessary Tools and Equipment

Provide the following tools for installing the Scalar 50 library:

- 3 mm Allen wrench
- 2.5 mm Allen wrench
- #1 flat blade screwdriver
- Antistatic wrist strap included in accessory kit

Taking ESD Precautions

Some components within the Scalar 50 library contains static-sensitive parts. To avoid damaging these parts while performing installation procedures, always observe the following precautions:

- Keep the library turned off during all installation procedures.
- Use an antistatic wrist strap (included in the accessory kit).
- Keep static-sensitive parts in their original shipping containers until ready for installation.
- Do not place static-sensitive parts on a metal surface. Place them inside their protective shipping bag or on an antistatic mat.

- Avoid touching connectors and other components.

Note: Dry climates and cold-weather heating environments have lower relative humidity and are more likely to produce static electricity.

Installing the Library

Installing a Scalar 50 library in a rack consists of the following steps:

- [Locating the Mounting Position](#)
- [Installing the Library](#)
- [Loading the Tape Cartridges](#)
- [Initial Configuration](#)

Locating the Mounting Position

The Scalar 50 library is designed to fit in a standard 19 inch wide rack.

It is important to the library installation to locate the hole pattern in the rack rails (see [figure 50](#)). The library must be installed at the beginning of the hole pattern. Refer to [table 49](#) for information on common rack hole types.

Table 49 Rack Hole Types

Figure	Description
	<p>Square rack holes are the most common type of rack holes. They can accept either cage nuts which mount from the back of the rail or clip nuts which clip on from the side of the rack rail.</p>

Figure	Description
	<p>Through holes require clip nuts to accept mounting hardware.</p>
	<p>Threaded holes require neither cage or clip nuts to accept mounting hardware.</p>

Note: The rails within the rack have a hole pattern that repeats throughout the rail. X marks the screw positions. Install nut clips (included in the accessory kit) on the rails if necessary.

Table 50 Scalar 50 Rail Hole Patterns and Mounting Positions

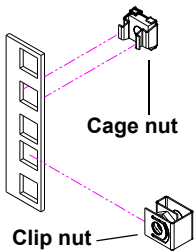
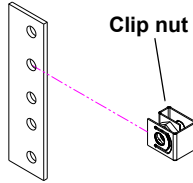
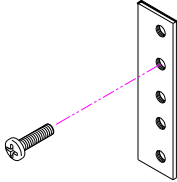
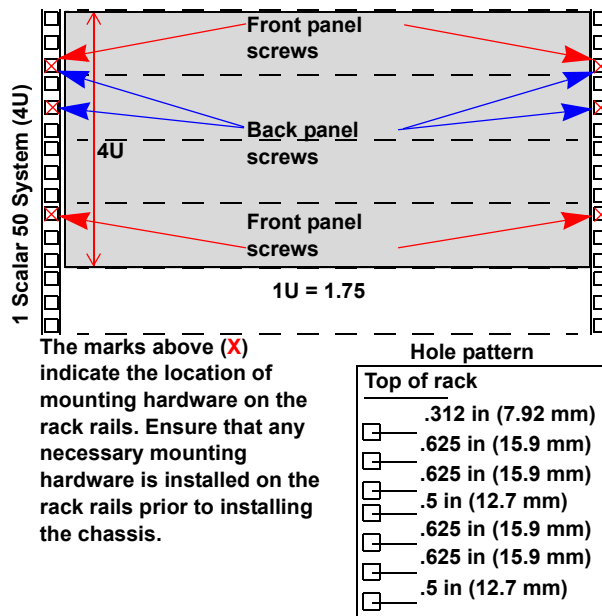

The marks above (X) indicate the location of mounting hardware on the rack rails. Ensure that any necessary mounting hardware is installed on the rack rails prior to installing the chassis.

Warning: If the rack is empty at the time of installation, do NOT install the Scalar 50 library too high in the rack. The weight of the library may cause the rack to become “top heavy” and unstable if installed in the top of an empty rack. Begin installing the Scalar 50 library from the bottom of the rack if more than one library is installed in the rack.

Installing the Library

Installing the Scalar 50 library consists of the following steps:

- [Installing the Rack Mount Shelves](#)
- [Installing the Library Chassis](#)
- [Cabling the Library](#)

Table 51 Library Mounting Hardware

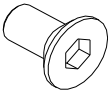
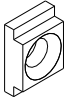
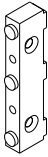
Qty	Figure	Description
16		Allen head screws (M5 x 10) for shelf assembly
8		T- nuts (M5)
4 metric and 4 standard		Rail adapters (both metric and standard holes are included, 8 total adapters)

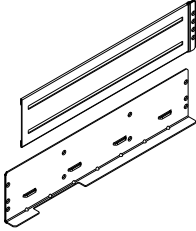
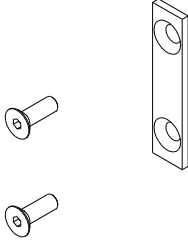
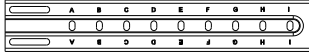
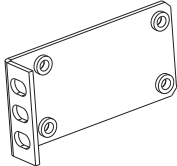
Qty	Figure	Description
2		Right and left support shelves (left shown)
4 sets		Front and back rail mounting hardware(M5 x 12 allen screws and mounting plates)
2 sets		Back bracket hardware (M5 x 8 allen screws and mounting plate)
2 sets		Back clamp hardware (M5 x 10 and back clamp)

Installing the Rack Mount Shelves

- 1 Assemble the rack mount shelves by (see [figure 104](#)):

- a Loosely attach the adjustable shelves (right and left) with 4 M5 x 10 Allen screws and T-nuts.

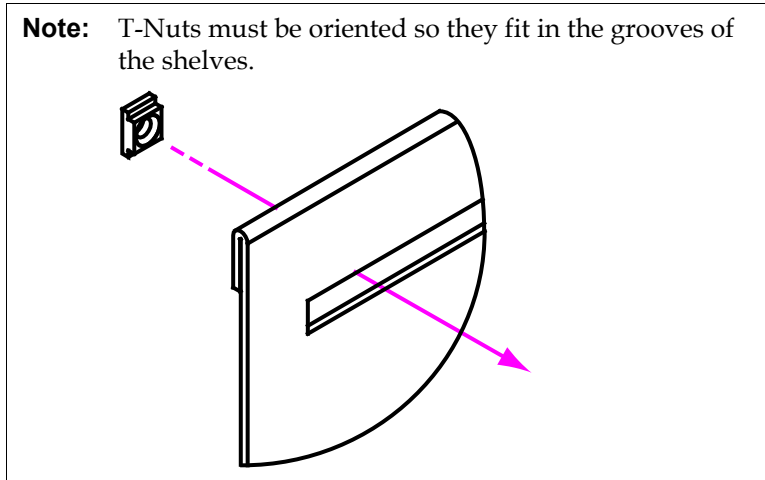

- b Attach the appropriate rail adapter to the front and back of the rack mount shelves (right and left) with 4 M5 x 10 Allen screws (each rail adapter is marked with the specific hole type supported, either metric or standard). The rail adapters have arrows indicating the proper orientation (see [figure 103](#)).

Figure 103 Rail Adapter Orientation

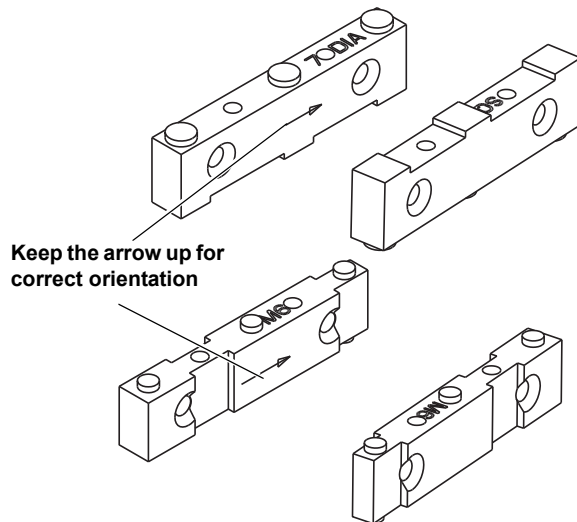

Figure 104 Assembling the
Left-Hand Rack Mount Shelves

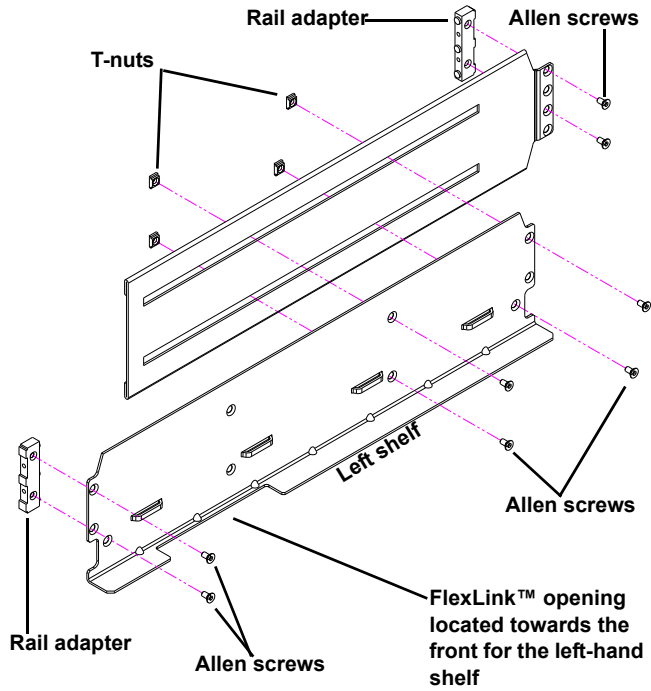
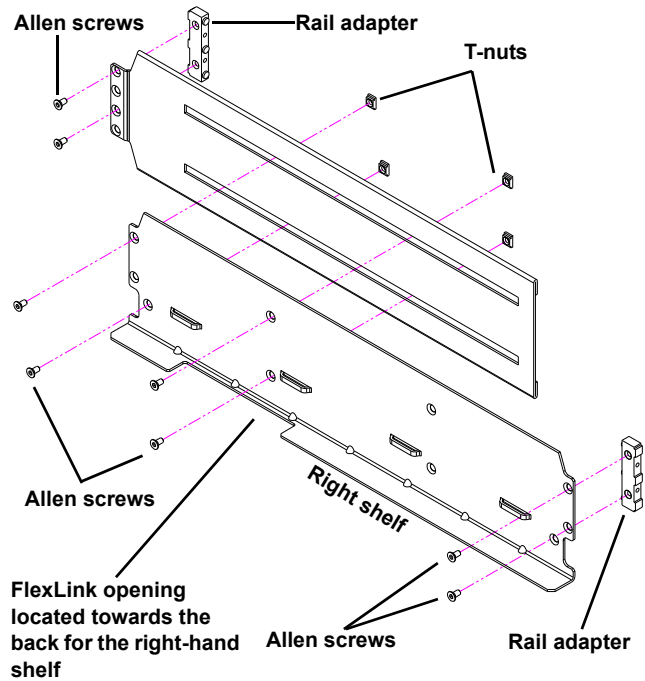

Figure 105 Assembling the
Right-Hand Rack Mount
Shelves



- 2 Install the left and right rack mount shelves into the rack (the rack mount shelves adjust 27 in. to 36 in.) and secure with a mounting plate and 2 M4 x 12 Allen screws at the front and back of the rack (see [figure 106](#)).

Note: The rack mount shelves must be installed on the inside rack rails.

Figure 106 Installing the Rack Mount Shelves

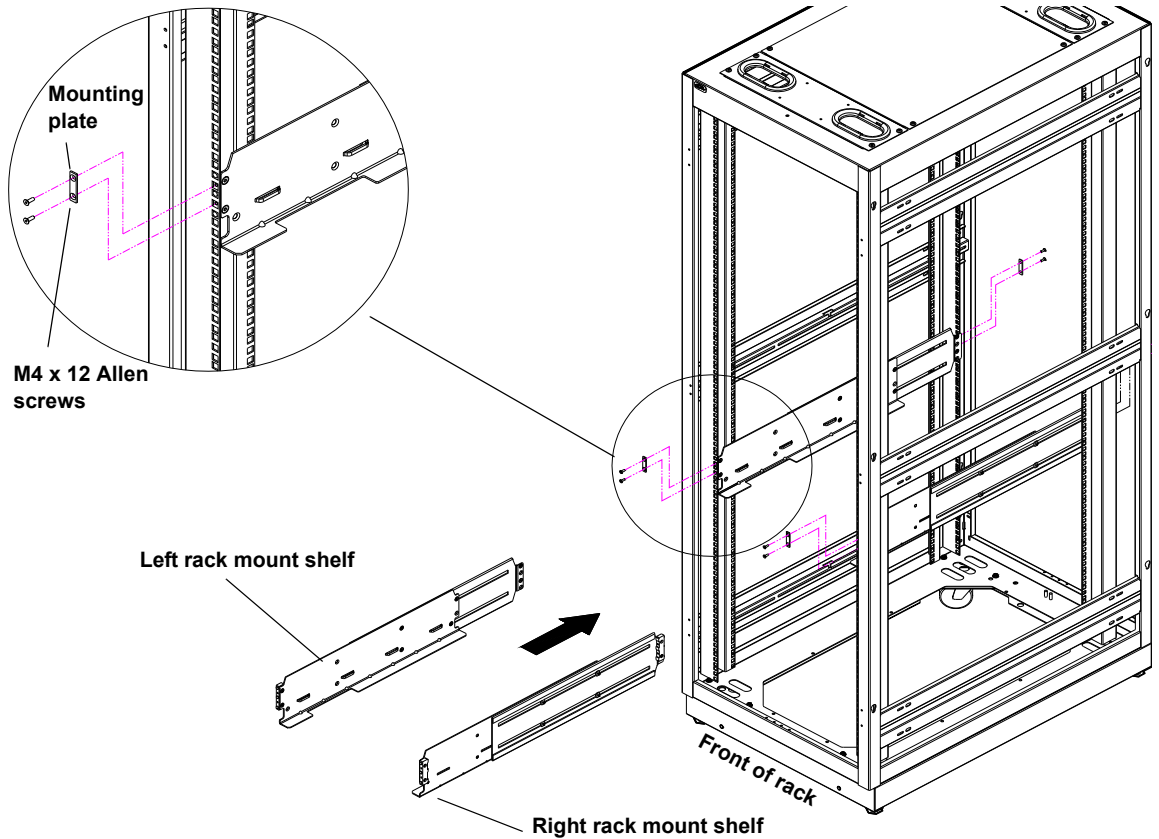

- 3 Once the rack mount shelves are secured to the rack, tighten the Allen screws securing the adjustable shelves together.

Installing the Library Chassis

Warning: The Scalar 50 weighs approximately 65 lbs (29 kg) without power supplies or tape drives. At least two people are required to lift and install either library.

- 1 The back mounting brackets are lettered (A through I) so the correct mounting position is easily determined. The mounting positions differ depending on the depth of the rack (see [table 52](#)).

Table 52 Back Mounting Bracket Orientation

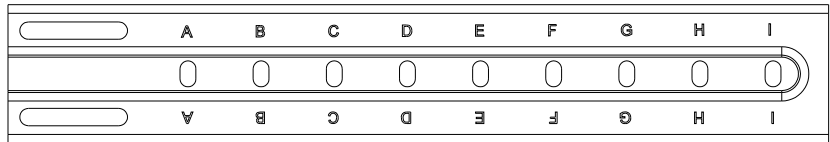

Rack Depth	Mounting Position
>27 to 28 in.	Use holes A and C
>28 to 29 in.	Use holes B and D
>29 to 30 in.	Use holes A and C
>30 to 31 in.	Use holes B and D
>31 to 32 in.	Use holes C and E
>32 to 33 in.	Use holes D and F
>33 to 34 in.	Use holes E and G
>34 to 35 in.	Use holes F and H
>35 to 36 in.	Use holes G and I

Once the location is determined, attach the back brackets to each side of the library with four M5 x 8 Allen screws (see [figure 107](#))

Note: Use the shortest depth number. For example, if the measurement is 34 in., use holes E and G.

Figure 107 Back Mounting
Brackets

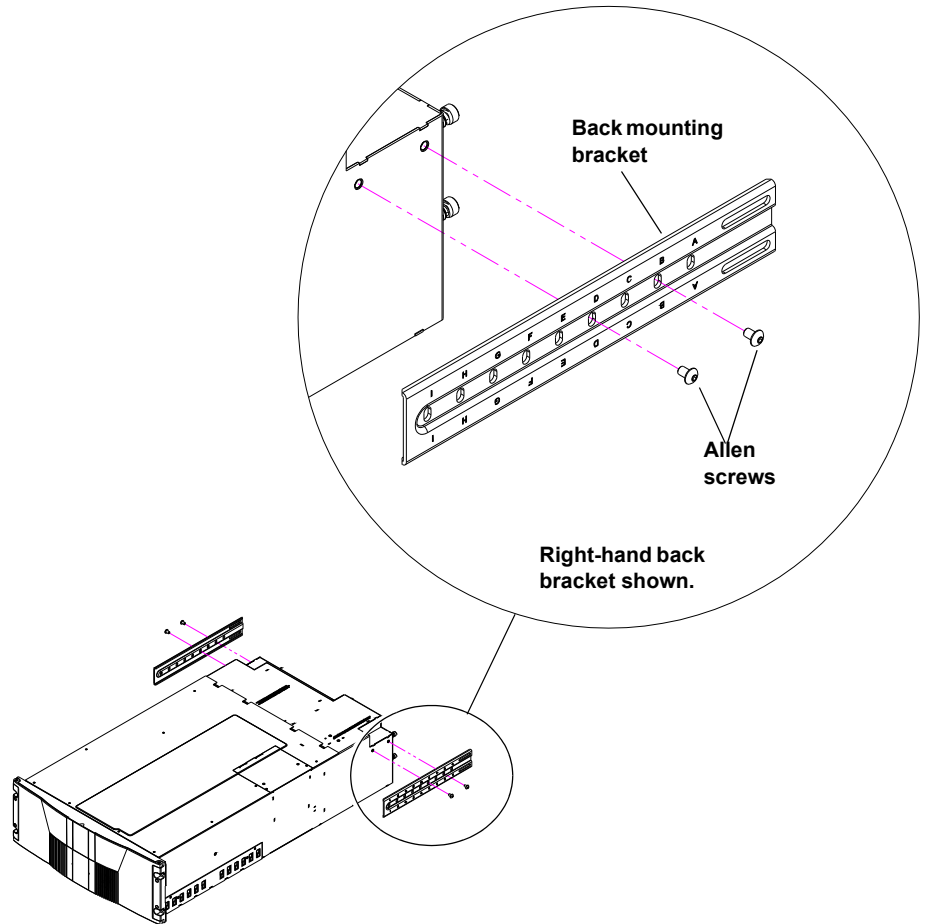

- 2 Install the library into the rack as shown (see [figure 107](#)).

Warning: The Scalar 50 weighs approximately 65 lbs (29 kg) without power supplies or tape drives. At least two people are required to lift and install either library.

Figure 108 Installing the
Scalar 50 in the Rack

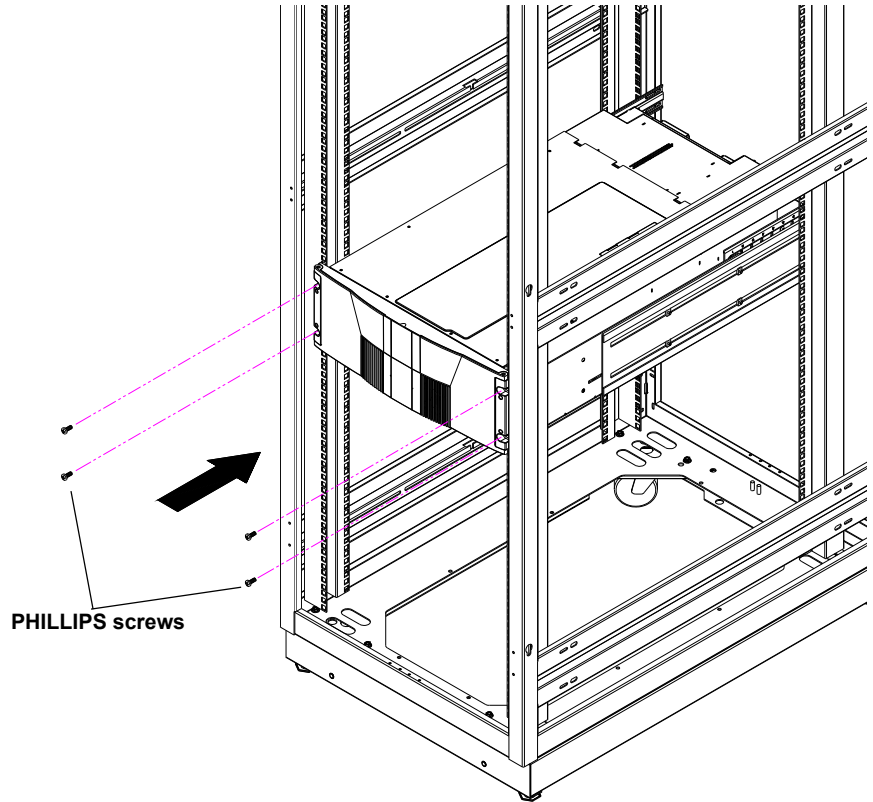

- 3 Secure the back of the library to the rack with two mounting clamps and two Allen screws on each clamp. The mounting clamps are oriented differently depending on the depth of the rack (see [figure 109](#)).

Note: If the rack depth is 27 to 30 in., the long portion of the clamp is mounted to the back. If the rack depth is 30 to 36 in., the long portion is mounted to the front.

- 4 Secure the mounting clamps to the rack rails with two PHILLIPS screws on each side (see [figure 109](#)).

Figure 109 Securing the Back of the Library

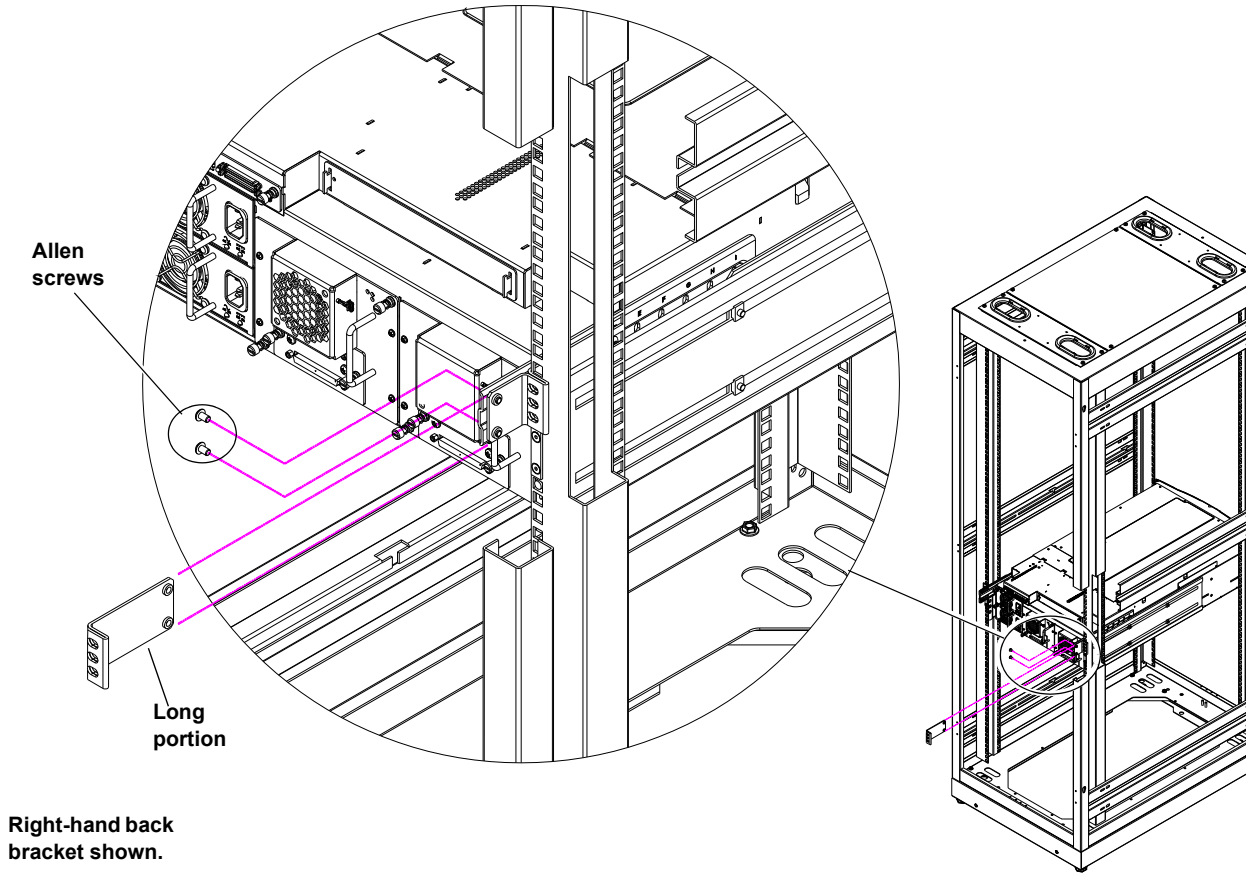

Warning: Hazardous Moving Parts.
Keep Fingers and Other Body
Parts Away When Removing
and Installing Tape
Drives.



**Warnung: Gefährliche bewegliche
Teile.** Halten Sie die
Finger und andere
Körperteile weg, wenn
Sie Bandlaufwerke
entfernen und
anbringen.

5 To install the tape drives into the library:

- a Insert the tape drive into the drive bay slowly until the connectors are seated (see [figure 110](#)).

Figure 110 Scalar 50 Tape
Drive Numbering

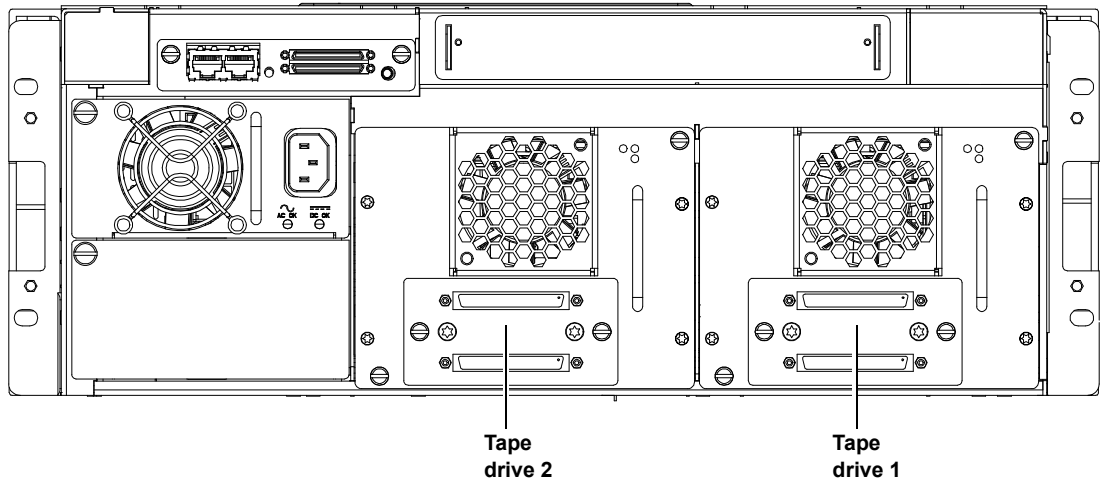

- b Tighten the tape drive captive screws using a flat blade screwdriver.
- c Repeat these steps to install another tape drive in a different location, if desired.

The library chassis is installed in the rack.

Cabling the Library

Connect the SCSI cables and jumpers as shown in the following figure:

- [Scalar 50 Cable Configuration \(SCSI Full Height Drives\)](#)
- [Scalar 50 Cable Configuration \(Native Fibre Channel Full Height Drives\)](#)
- [Scalar 50 Cable Configuration \(SCSI Half-Height Drives\)](#)
- [Scalar 50 Cable Configuration \(SAS Half-Height Drives\)](#)

- [Scalar 50 Cable Configuration \(Native Fibre Channel Half-Height Drives\)](#)

Note: Quantum ships sufficient SCSI cables and terminators with the libraries to set up two-drives per SCSI bus.

Stacked Configuration

- [Scalar 50 Cable Configuration \(Stacked\)](#)

Figure 111 Scalar 50 Cable Configuration (SCSI Full Height Drives)

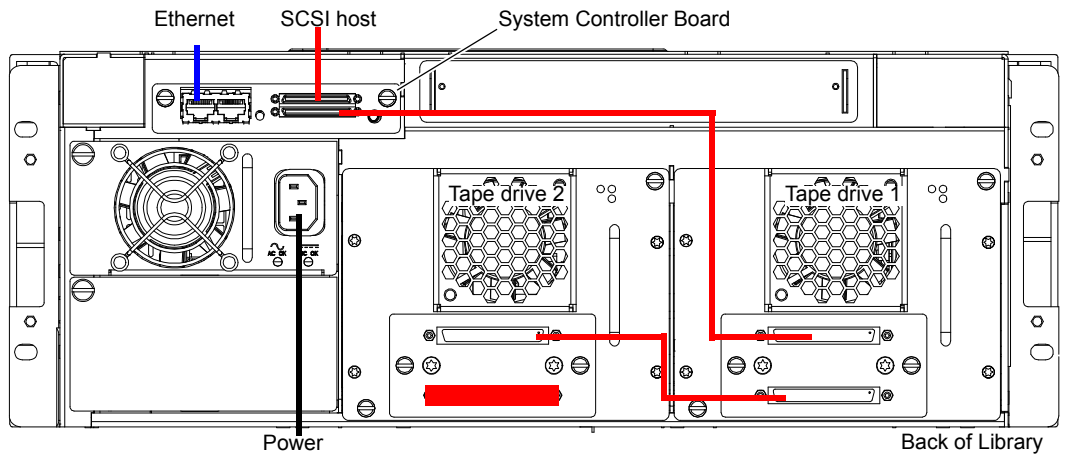

Figure 112 Scalar 50 Cable Configuration (Native Fibre Channel Full Height Drives)

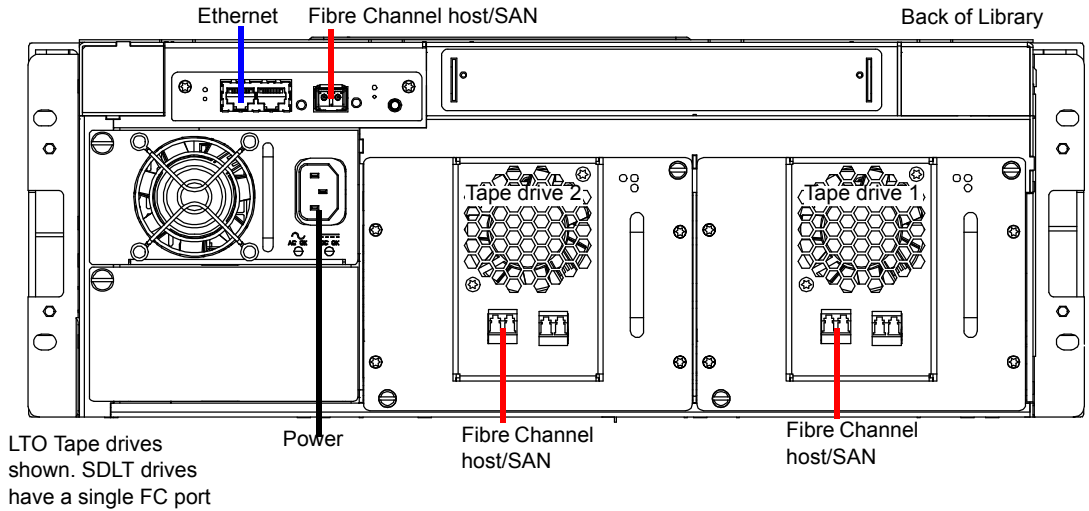

Figure 113 Scalar 50 Cable Configuration (SCSI Half-Height Drives)

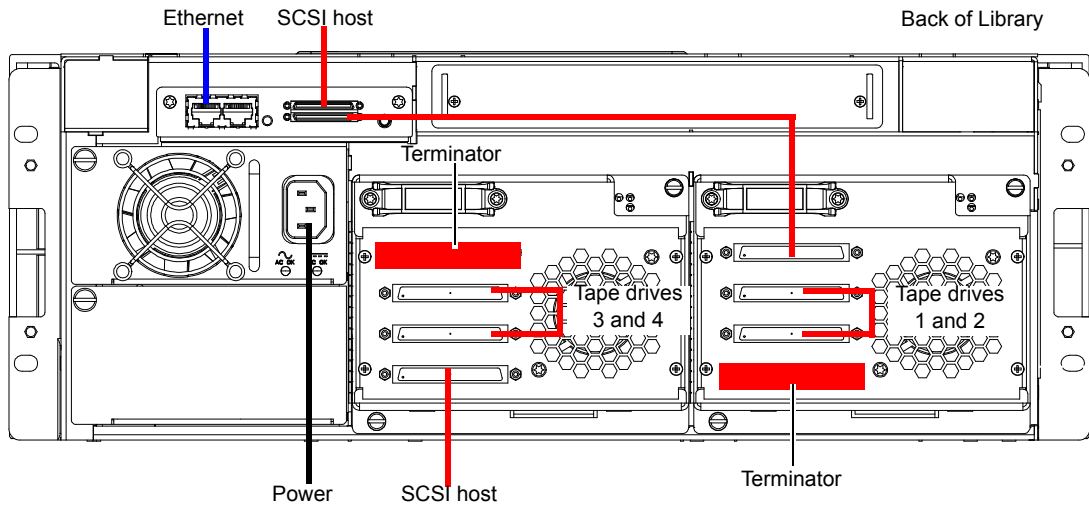

Figure 114 Scalar 50 Cable Configuration (SAS Half-Height Drives)

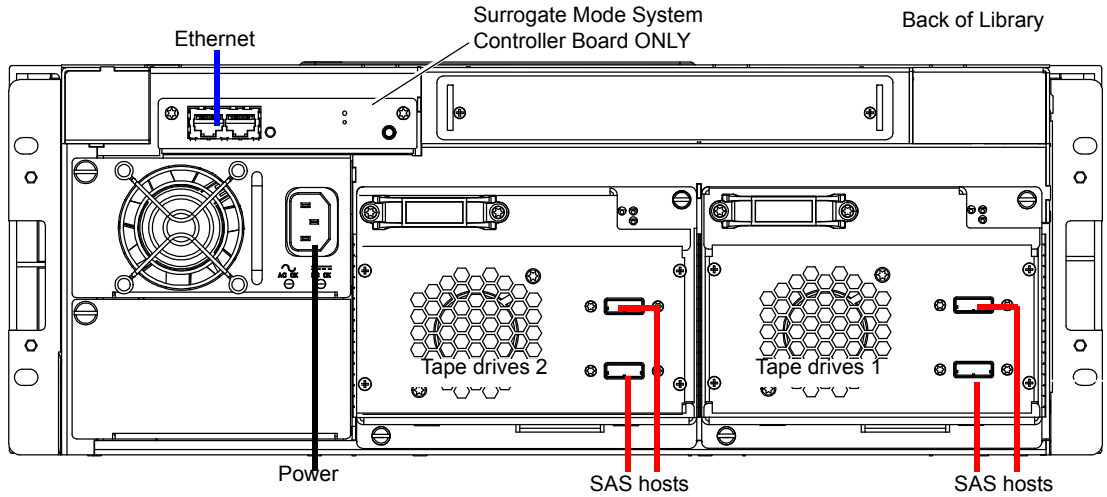

Figure 115 Scalar 50 Cable Configuration (Native Fibre Channel Half-Height Drives)

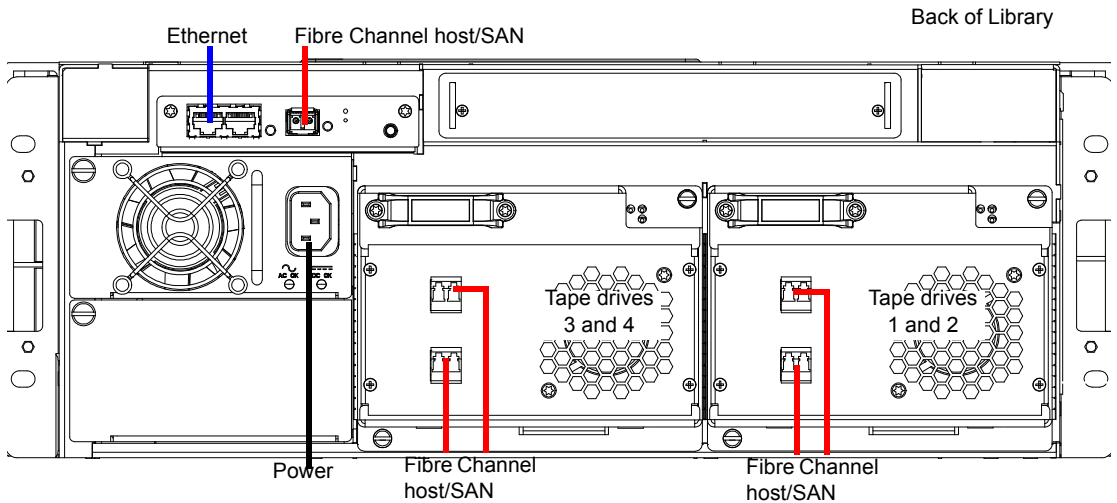
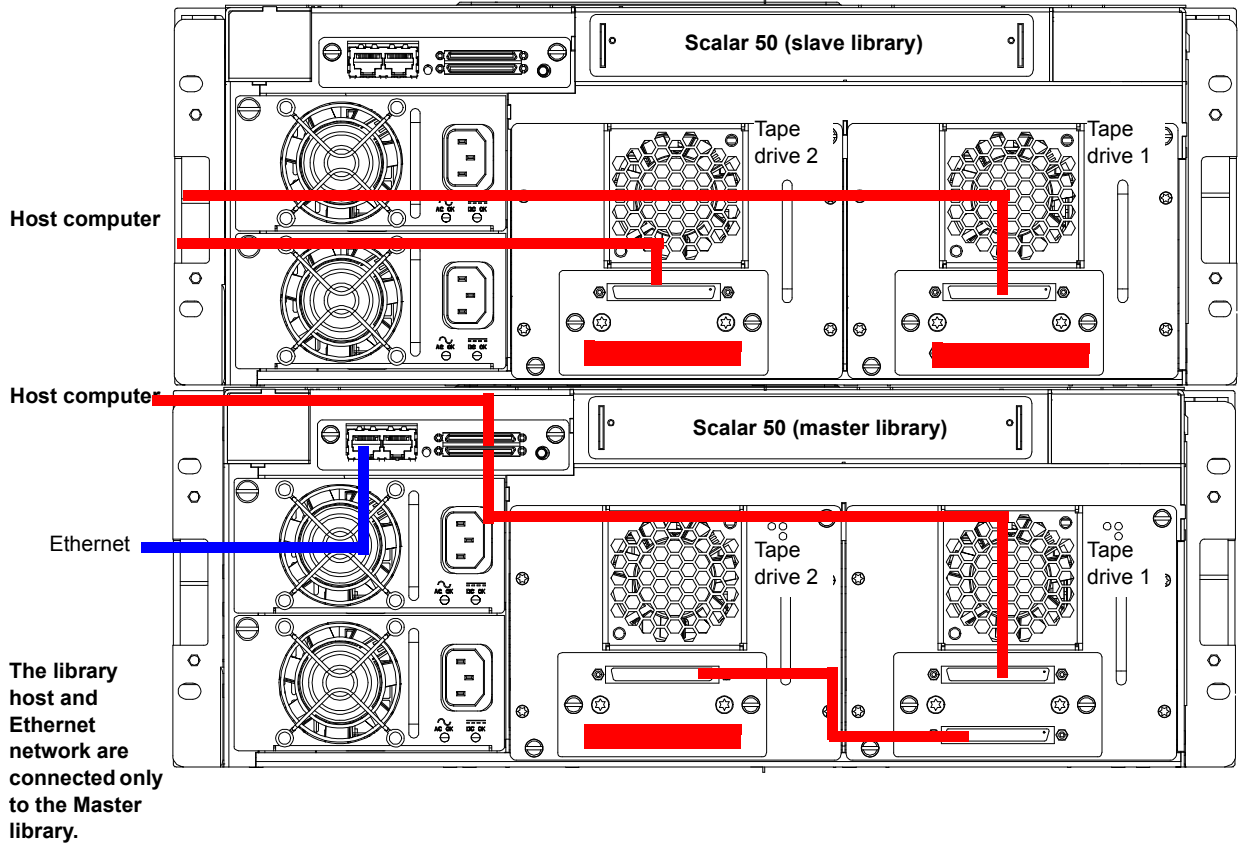

Figure 116 Scalar 50 Cable Configuration (Stacked)



Loading the Tape Cartridges

Before operating the library, load the appropriate tape cartridges (LTO and/or SDLT) into the library starting with the left-hand magazines (refer to [Preparing the Library for Operation](#) on page 30 for more information on tape cartridges).

Initial Configuration

Initially configuring the library consists of the following steps:

- [Turning on the Library](#)
- [Setting the Date and Time](#)
- [Setting Network Information](#)

Turning on the Library

To turn on the library:

- 1 Verify that:
 - Power cables are firmly in place
 - All doors are closed
- 2 Turn on the power switch located in the lower left-hand corner of the OCP (see [figure 117](#)).

Figure 117 Turning On the Library

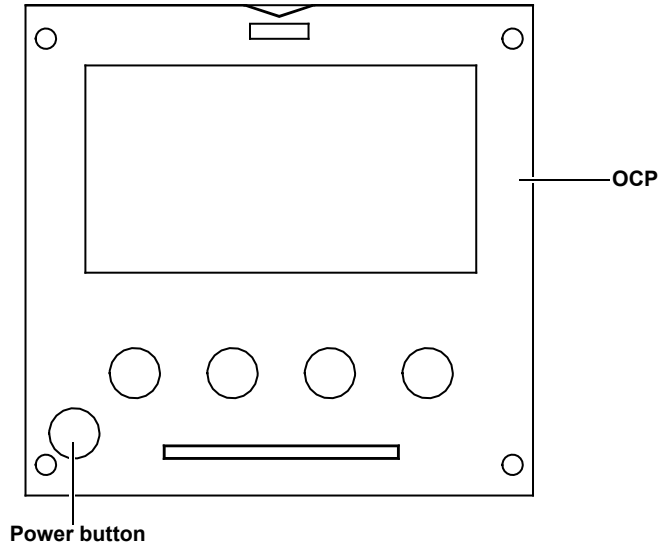

- 3 When the library powers on for the first time after the hand has been parked for shipping, the OCP asks you:
“Hand Restraint Found. Please Remove! Starting Shutdown...”

- 4 The OCP then displays:

“Doors opened, magazines released, pull magazines out before power shutoff.”

The library waits approximately 30 seconds for you to open the doors, remove both magazines from the library, and remove the hand restraint.

Note: If you are unable to remove the magazines before the library shuts down. Turn on the library power and repeat the steps above.

- 5 After the library has powered down, remove the hand restraint by completing the following steps (see the *Scalar 50 Quick Start Guide* for more information):
 - a Remove the two thumb screws securing the hand restraint to the base of the library.

- b Remove the hand restraint from the library.

Caution: Avoid touching the printed circuit board.

Caution: When removing the hand restraint, ensure that the robotics umbilical cable is lying down in the correct position inside the platform and not across the robotics track.

- c Store the thumb screws and the restraining bolt in the hand restraint.
 - d Install the tape cartridge magazines.
 - e Close the front doors.
- 6 Turn on the library by pushing power button located on the bottom left-hand corner of the OCP (see [figure 117](#)).
 - 7 The OCP asks you:
“**Are the Shipping Restraints Removed?**” (YES or NO).
 - 8 Press YES to continue.
 - 9 The OCP asks again:
“**Are you sure the Hand & Thumb Screw Restraints have been Removed?**” (YES or NO).
 - 10 Press YES to continue. The library continues the boot process. When complete, the **Home** screen displays.

Note: If the library encounters difficulties during the boot process, there may be obstructions inside the library. The the OCP will display: “**Please Remove Restraining Bolt, or Hand Restraint. See User’s Guide.**” Shut down the library, open the doors with the emergency access tool and check for obstructions. Be sure to check for the restraining bolt on the left side of the cabinet.

- 11 Press **Setup** from the **Home** screen. The OCP displays the **Setup** screen (see [figure 118](#)):

Figure 118 Setup Screen



- 12 From the **Setup** screen, use the up and down arrows to highlight **Cabinet** and press **Enter**.

The **Cabinet** screen displays (see [figure 119](#)):

Figure 119 Library Options Screen

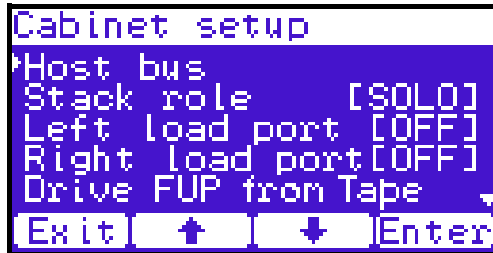

- 13 The **Stack role** screen allows you to configure the library as a “Master” or “Slave” in a multiple library stack. The library is configured “Stand alone” by default. If this is a multiple library stack, use the up and down arrows to highlight **Stack role** and press **Enter** displays the following information about the library:

Note: All Scalar 50 libraries must have **FULL** capacity before configuration as a stack is possible. PX502 libraries in a stack are considered fully licensed. Configure each unit that will be stacked as a stand alone unit and enable **Full** capacity through the remote management pages (see [Library](#) on page 125). After full capacity is enabled, change the stack role(s) accordingly to create the multiple library stack.

Table 53 Setting Up the Cabinet

Cabinet Options	Description
Host bus	Sets the SCSI ID for both the library and tape drives.
Stack role	Assigns the library stack role as Master, Slave, or Stand alone. There can be only one Master library in a multiple stack. Once configured as a slave, all library OCP functions can be controlled via the Master library OCP.
Left load port	Enables or disables the left load port
Right load port	Enables or disables the right load port
Drive FUP from tape	Allows you to perform a tape drive firmware update from a firmware update tape cartridge.

Setting the Date and Time

To set the date and time:

- 1 From the **Setup** screen, use the up and down arrows to highlight **Date and Time** and press **Enter**.

The **Date and Time** screen displays (see [figure 120](#)):

Figure 120 Date and Time Screen



The **Date and Time** screen displays the following information about the library:

- 2 Use the up and down arrows to view or edit the date and time information. Press **Enter** to accept the new settings.
- 3 When you are finished viewing/editing the date and time information, press **Exit** to return to the **Setup** screen.

Setting Network Information

To view or edit the network information:

- 1 From the **Setup** screen, use the up and down arrows to highlight **Network** and press **Enter**.
- 2 The **Network** screen displays (see [figure 120](#)):

Figure 121 Network Screen



The **Network** screen allows you to view or edit the following network settings:

Note: The network settings (IP address, subnet mask, and default gateway) are only active when DHCP is disabled.

- DHCP (default setting)
 - IP address
 - Subnet mask
 - Default gateway
- 3 Use the up and down arrows to select the network setting you wish to view or edit and press **Enter**.

When you are finished viewing/editing the network information, press **Exit** to return to the **Setup** screen.

- 4 For the network information such as the IP address to be active, you must reboot the library by holding down the power button located on the front of the library (see [figure 117](#)).

The library shuts down.

- 5 Push the power button to start the library.

The Scalar 50 tape library is initially configured and ready for use.

Emergency Library Access

Use the following procedure to gain access to the tape cartridge magazines in case of an emergency and the library power is not available.

- 1 Put on an antistatic wrist strap and clip it to the library chassis (example: a captive screw on the tape drive cover plates).

Caution: Take standard ESD precautions when performing this procedure.

- 2 Insert the door release tool included with the accessory kit into the release holes and trip the magazine door release for both the right and left magazine doors (see [figure 122](#)).

The magazine access doors open.

Figure 122 Opening the Right
and Left Magazine Access
Doors

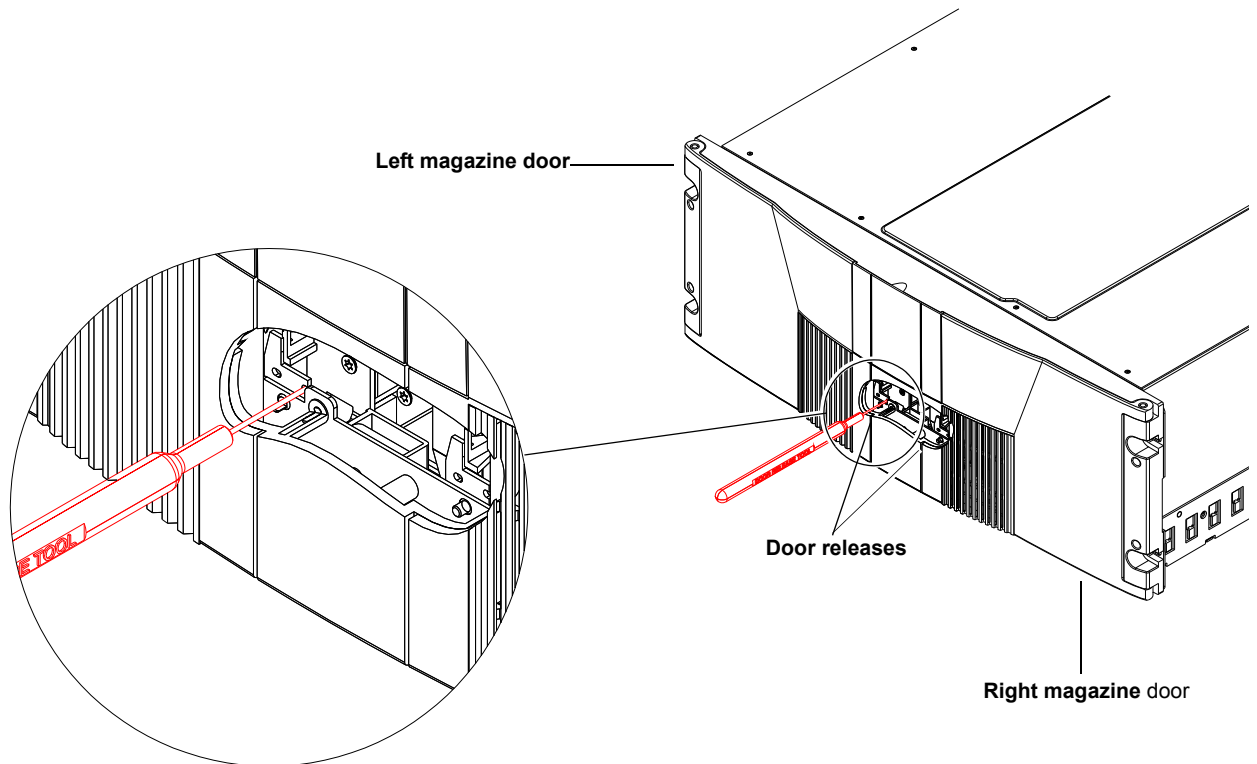

- 3 Insert the door release tool that is included in the library accessory kit into the magazine release hole and trip the magazine release to remove the each magazine from the library (see [figure 123](#)). Remove both magazines from the library.

The tape cartridge magazines are now accessible.

Figure 123 Removing the
Magazines

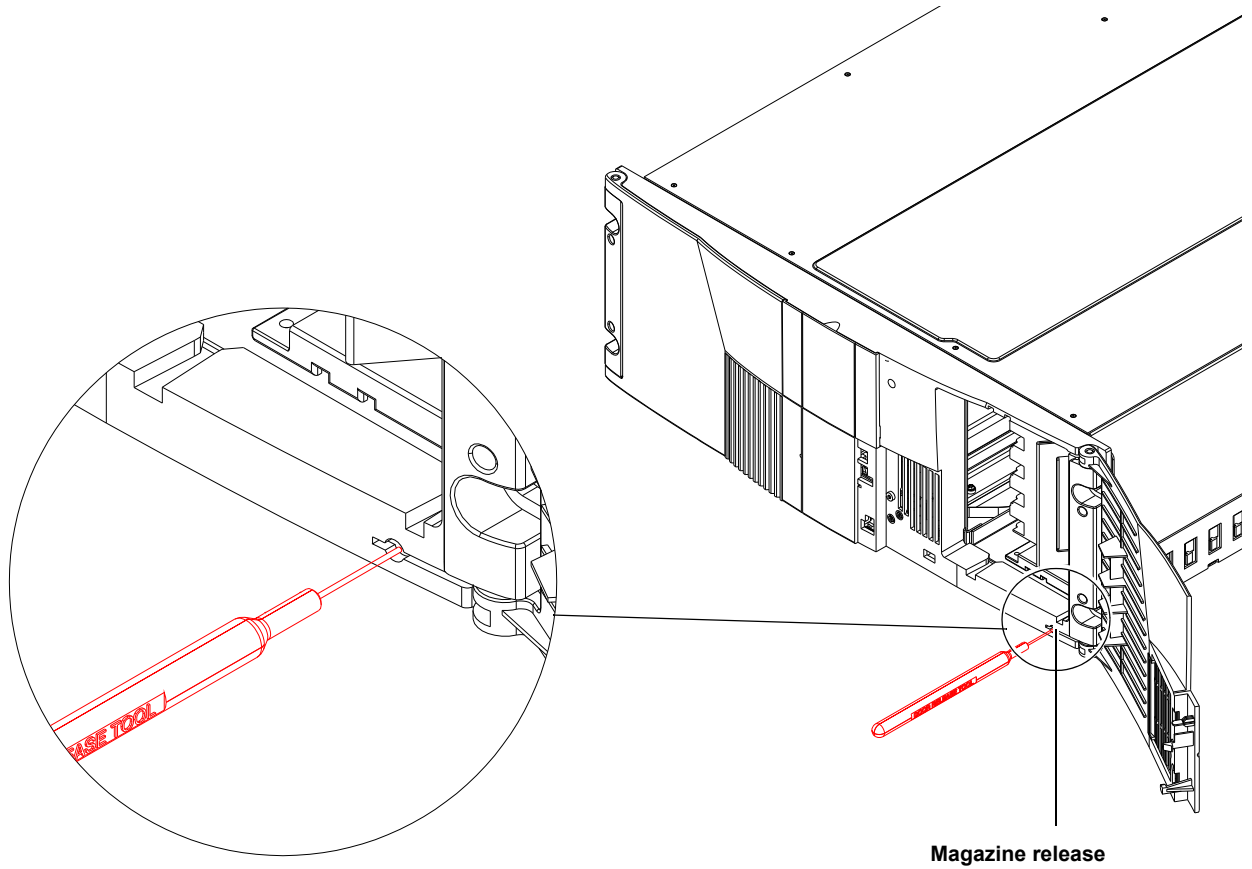

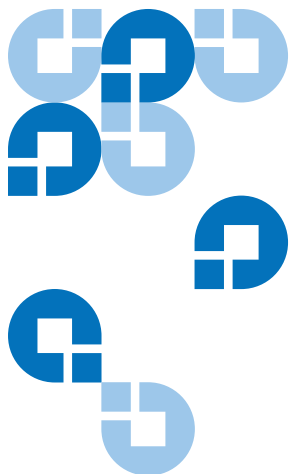

Appendix D

Repacking the Scalar 50 Library

This document explains how to repack the Quantum Scalar 50 library. Follow these instructions carefully to ensure the library is shipped properly.

Note: All Scalar 50 documentation is located on the Scalar 50 Documentation CD included in the library accessory kit.

Caution: This procedure requires the packing materials originally sent with the library for proper shipment. If you do not have the library packing materials, contact Quantum customer support for replacement packaging (800) 284-5101.

This procedure consists of the following steps:

- [Removing the Library from the Rack](#)
- [Installing the Internal Shipping Restraints](#)
- [Packing the Library for Shipment](#)

Removing the Library from the Rack

To remove the Scalar 50 library from the rack:

Note: You must remove all tape cartridges from the library prior to parking the library robotics for shipment.

- 1 Using the OCP, open the front doors, remove both tape cartridge magazines, and remove any tape cartridges from the fixed bins or FlexLink™ (refer to the *Quantum Scalar 50 User's Guide* PN 81-81768 for information on OCP operation and bin locations).

After removing the tape cartridge magazines and closing the doors, the library inventories all possible tape cartridge locations (magazines, fixed slots, Flexlink, and tape drives). This process takes several minutes.

- 2 From the **Library Operations** screen on the OCP, select **Park for Shipping**. The library shuts down automatically.

Note: If there are tape cartridges in the library, the system will NOT park the library robotics. You must remove all tape cartridges from the system prior to parking the library robotics.

- 3 From the back of the library, disconnect all power, Ethernet, and SCSI cables from the library and note their locations for later reinstallation.

Warning: This unit has more than one power supply cord. Disconnect all power supply cords before servicing to avoid electric shock.

- 4 To remove the library chassis from the rack (see [figure 124](#)):

Note: Refer to the *Scalar 50 Quick Start Guide* (PN 81-81767) for additional Scalar 50 rack mount information.

- f Loosen the captive screws securing the tape drives to the chassis and remove the tape drive(s) from the back of the library.

- g** Loosen the captive screw securing the power supplies to the chassis and remove the power supplies from the back of the library.
- h** Remove Phillips screws securing each side of the chassis to the rack mounting rails and remove two Allen screws securing both clamps on the back of the library.
- i** Remove the library from the rack.

Warning: At least two people are required to move the library chassis.

Figure 124 Removing the Scalar 50 Library

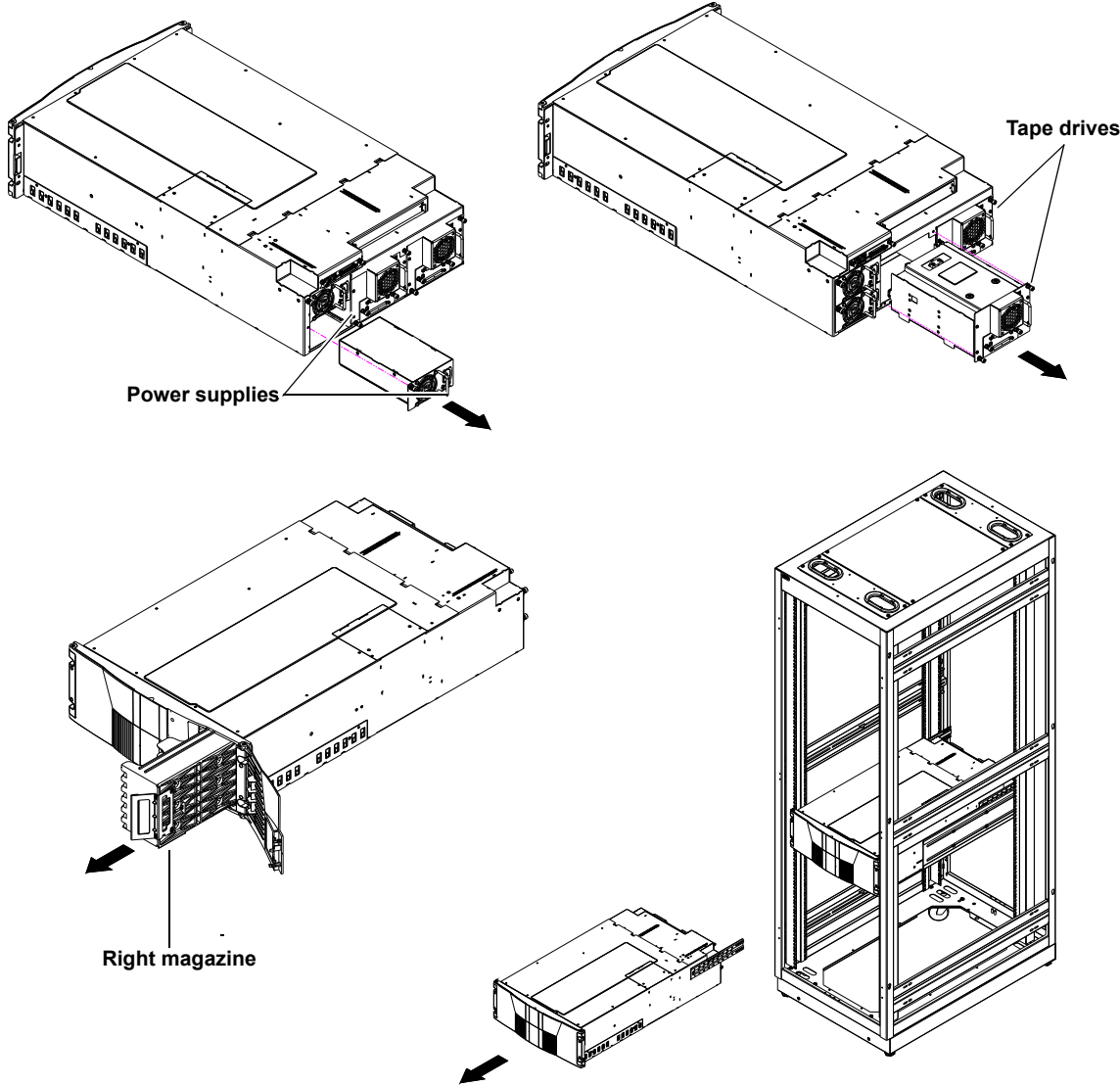

Installing the Internal Shipping Restraints

To ensure that the internal robotics within the library is not damaged, you must install the internal shipping restraints on the robotics.

Caution: Failure to install the shipping restraints on the robotics may void your warranty.

To install the internal shipping restraints:

- 1 Place the library on a flat surface approximately waist high:

Note: If the bottom FlexLink cover has been removed, replace it before shipping the library back to Quantum.

- 2 Insert the emergency access tool included with the accessory kit into the release holes and trip the magazine door release for both the right and left magazine doors (see [figure 125](#)).

The magazine access doors open.

Figure 125 Opening the Right and Left Magazine Access Doors

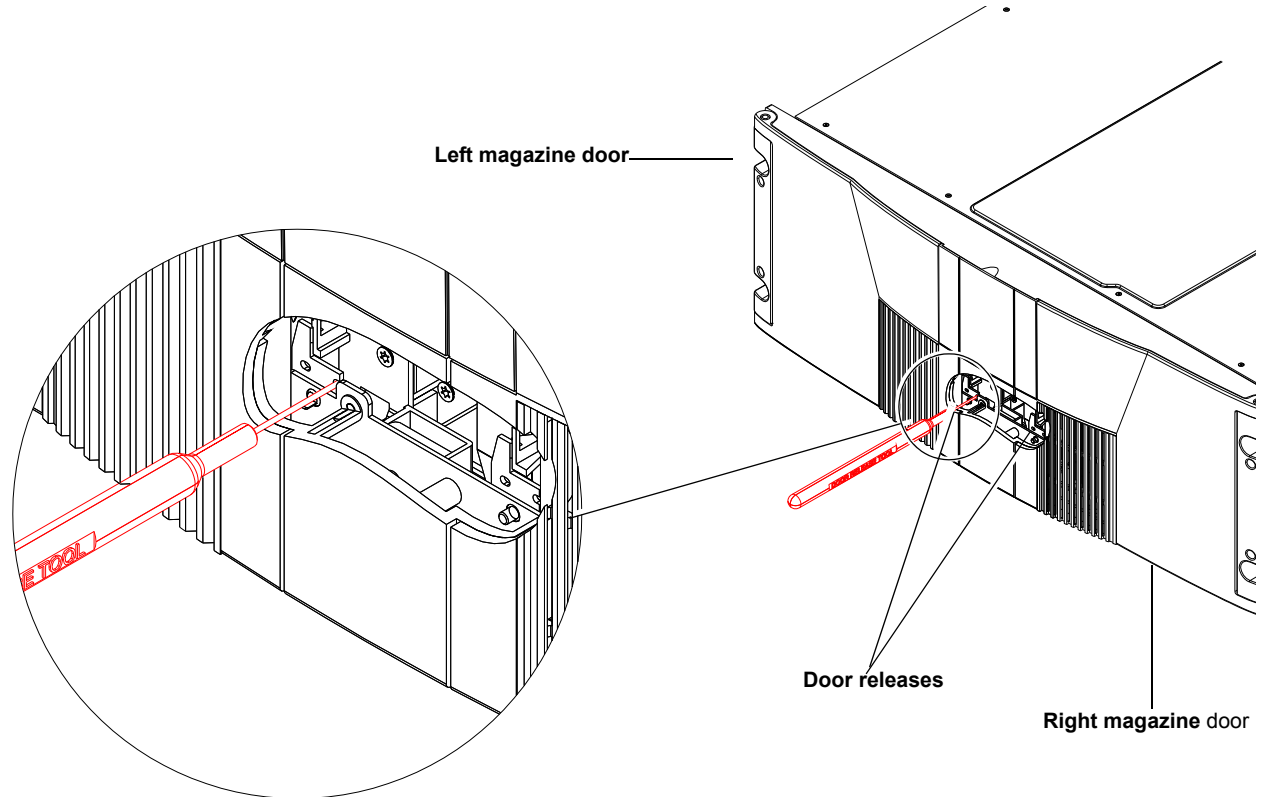

- 3 If the library is not operational and the **Park for Shipping** command was not executed, grasp the robotics and gently move it to the front of the library.

Caution: Take standard ESD precautions when working within the library chassis.

Note: If there are any cartridges in the fixed bins, you can remove them now.

- 4 Install the robotic restraint over the robotics and secure with two thumb screws [figure 126](#).

Figure 126 Installing the Hand Restraint

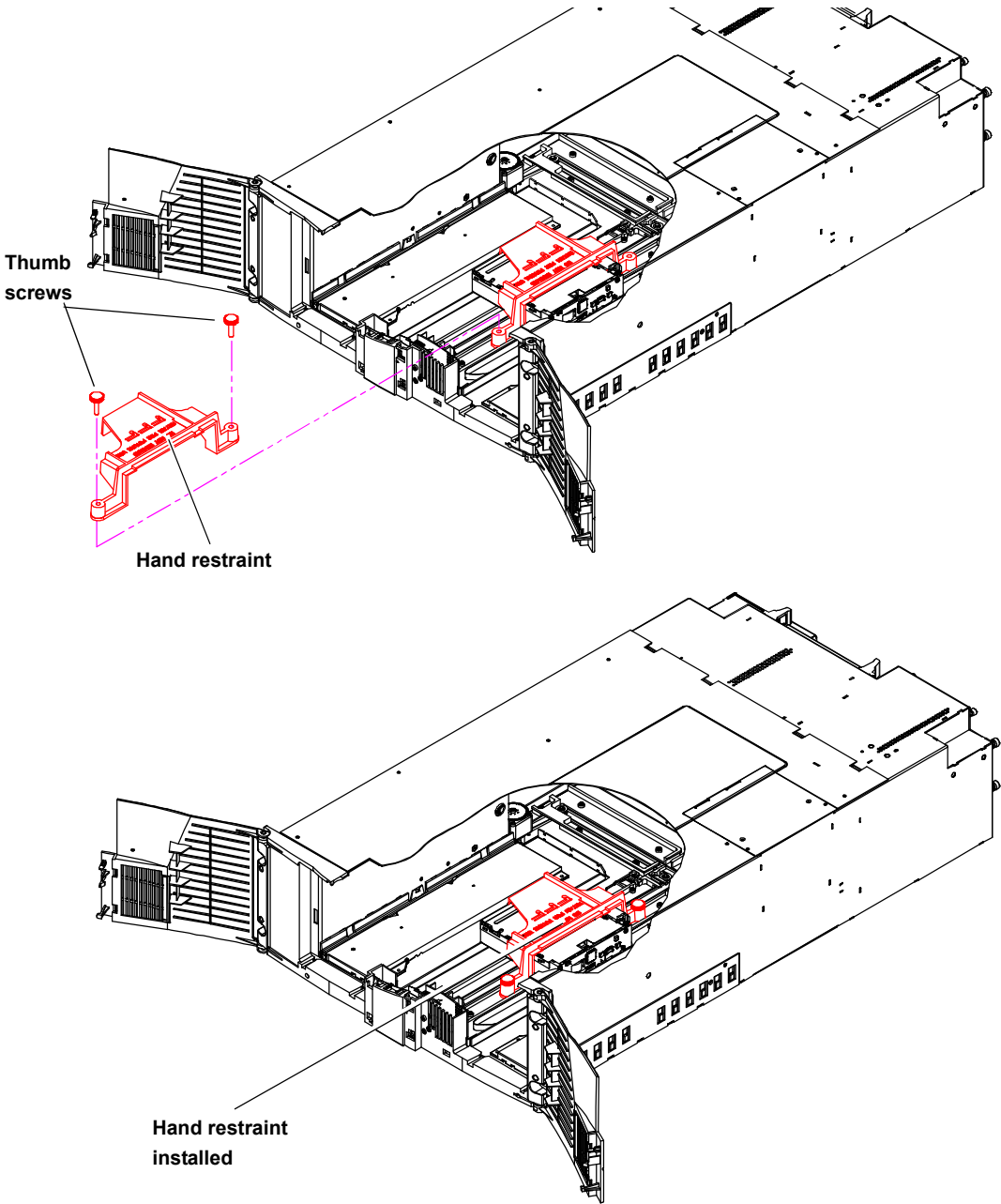

- 5 Replace the tape magazines and close the front doors.
- 6 Install the thumb screw restraint on the left-hand side of the library chassis (see [figure 127](#)).

Figure 127 Installing the Restraining Bolt

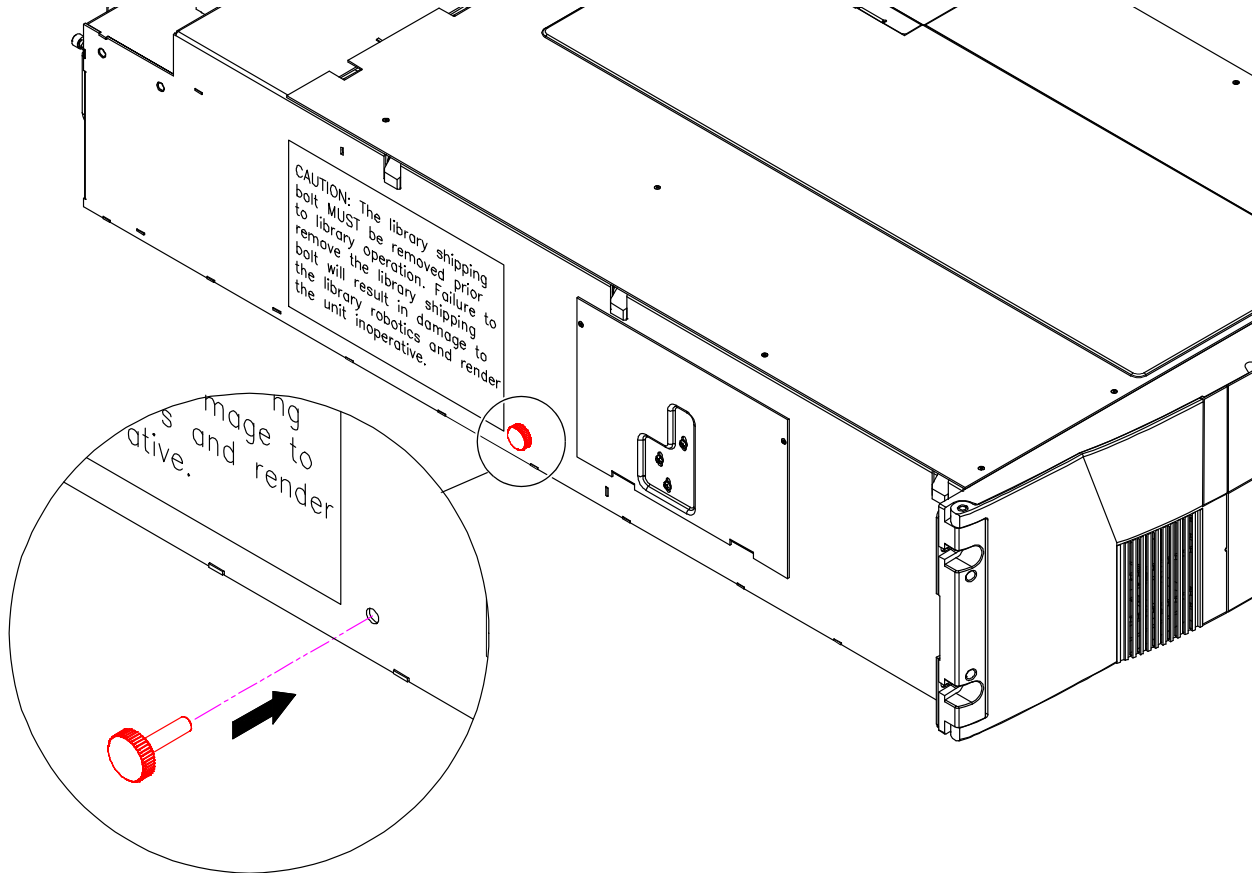

- 7 Install the tape drives, and power supplies previously removed in [Removing the Library from the Rack](#).
- 8 Install the tape cartridge magazines.

Packing the Library for Shipment

- 1 Carefully place the library into the antistatic bag.
- 2 Package the library into the shipping carton as shown in [figure 128](#). Ensure that the library chassis is placed in an antistatic bag before placing the library in the shipping carton

Warning: At least two people are required to move the library chassis.

Caution: Lift the library chassis at the sides. Avoid putting the weight of the library chassis on the front bezel.

Figure 128 Preparing the Library for Shipping

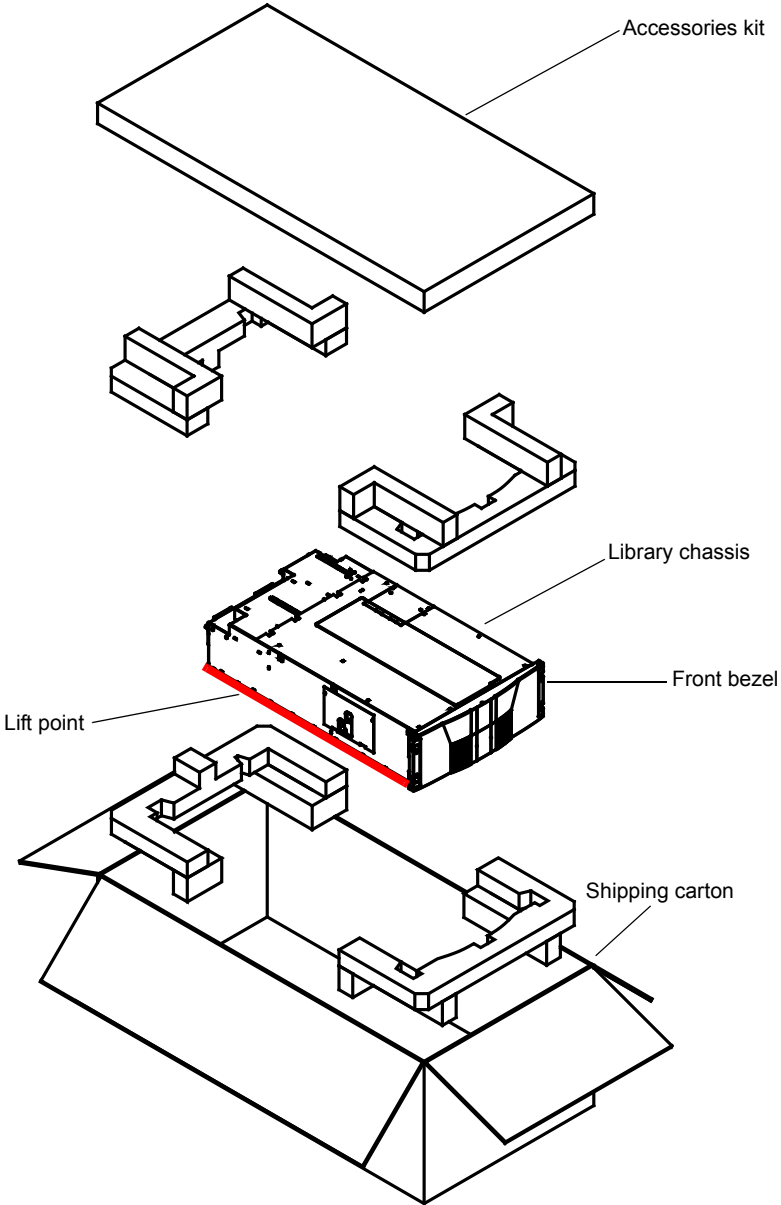

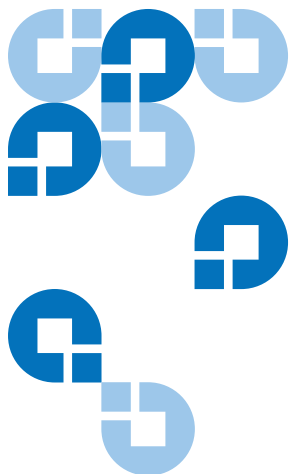

Firmware Upgrade Instructions for Stacked Libraries

If Scalar 50 libraries are in a multiple library stack, the library firmware must be uploaded individually to each cabinet. If you attempt to upload library firmware to only the Master library in the stack, the slave libraries may not receive the firmware update properly.

Uploading library firmware to a multiple library stack consists of the following steps:

Note: If your libraries are partitioned, the partitioning information will be lost after the firmware upgrade. You must recreate the partitions after the firmware upgrade is complete.

- [Changing the Library Stack Role](#)
- [Uploading Library Firmware](#)
- [Returning the Library Stack Role](#)

Changing the Library Stack Role

The library must be in **Stand alone** mode prior to receiving the library firmware update.

To change the library stack role:

- 1 From the Operator Control Panel (OCP), press **Setup** from the **Home** screen.

The OCP displays the **Setup** screen (see [figure 129](#)):

Figure 129 Setup Screen



- 2 From the **Setup** screen, use the up and down arrows to select **Cabinet** and press **Enter**.

The **Cabinet** screen displays (see [figure 130](#)):

Figure 130 Cabinet Screen

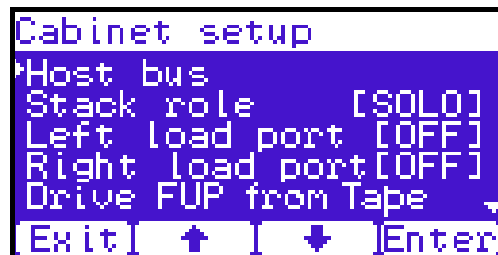

- 3 Use the up and down arrows to select **Stack role** and press **Enter**.

The **Stack role** screen displays.

Note: Make note of the original stack role. You must return the library to its original stack role after the library firmware has been updated.

- 4 Use the up and down arrows to select **Stand alone** and press **Enter**.
The system prompts you with a confirmation screen asking **Change to Standalone and reboot this system?**
- 5 Press **Yes**.
The library shuts down. Continue with [Uploading Library Firmware](#).

Uploading Library Firmware

After the library stack role is set to **Stand alone**, you can upload library firmware to the cabinet.

To upload library firmware:

- 1 Connect an Ethernet cable to the left-hand Ethernet port on the library SCB and to a network host on the same subnet as the library (see [figure 131](#)).

Note: If this was the **Master** library, there will already be an Ethernet cable connected to the library SCB.

Figure 131 Connecting to the Library SCB

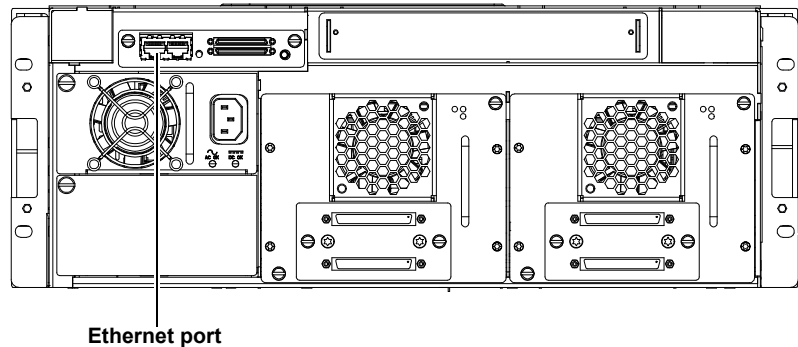

- 2 Use the OCP to determine the IP address for the library. The **Network information** is available from the **Info** menu.
- 3 On the host computer, open the internet browser software.
- 4 In the **Address** field, type `http://IPaddress/` where IP address is the IP address for the library.
- 5 Enter the username and password and click **OK**.

Note: The default username and password is **admin**.

The **Overview** page displays (see [figure 132](#)).

Figure 132 Overview Page

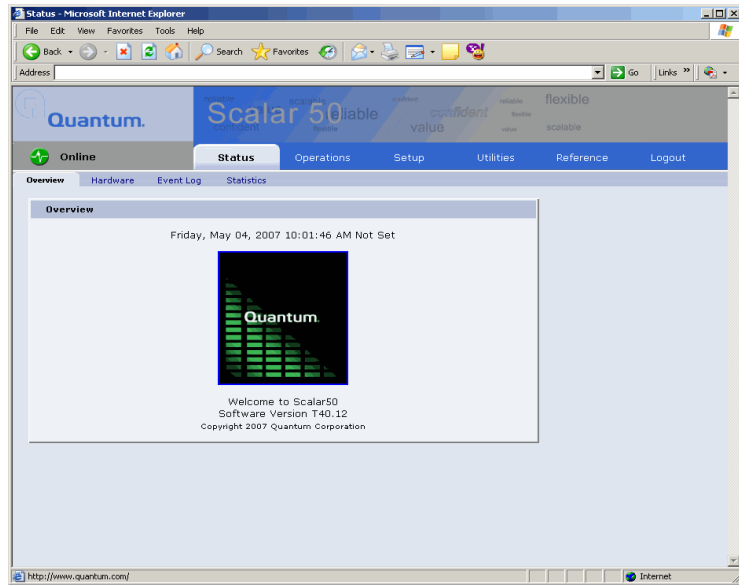

- 6 Click the **Utilities** tab at the top of the page.
The **Utilities** page displays (see [figure 133](#)):

Figure 133 Utilities
Page

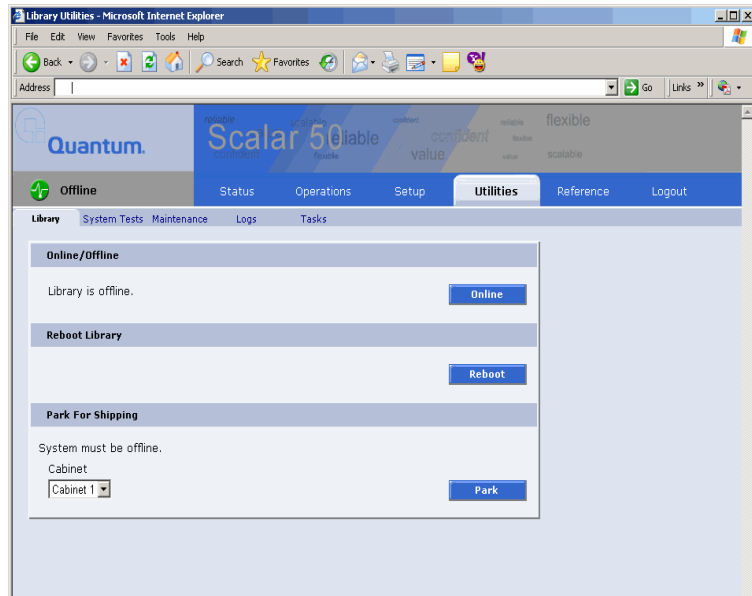

- 7 Click the **Maintenance** tab at the top of the page.
The **Maintenance** page displays (see [figure 134](#)).

Figure 134 Maintenance Page

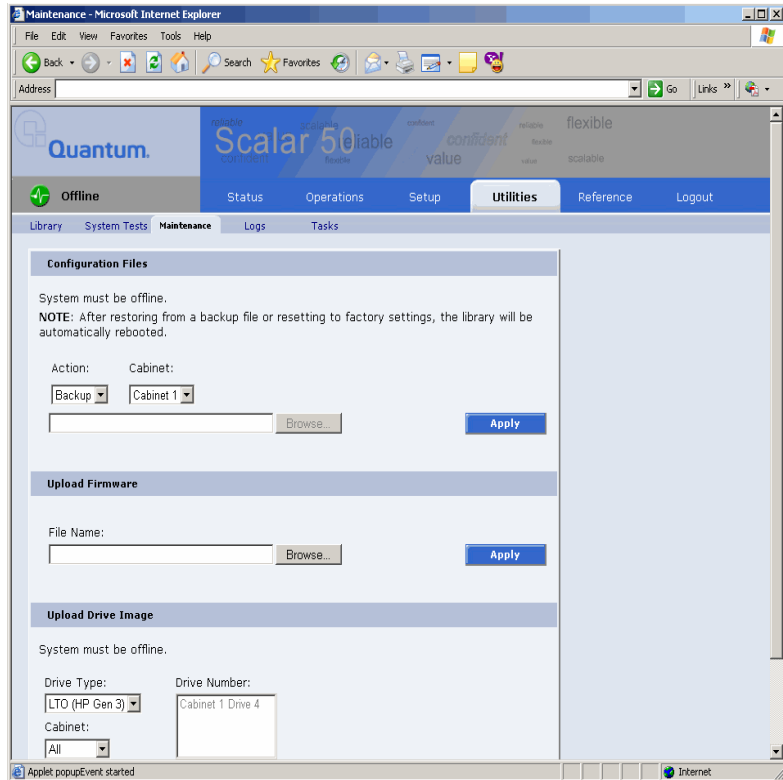

- 8 To upload the library firmware, enter a path and filename where the file exists, or click **Browse**.

Note: Be sure to use the same library firmware for all libraries in the stack.

- 9 Click **Apply** to upload the file.

The firmware image uploads to the library.

- 10 Reboot the library from the **Utilities** page (see [figure 133](#)).

The library reboots. Repeat the firmware upgrade procedure for every library in the stack. When all libraries have been updated, continue with [Returning the Library Stack Role](#).

Returning the Library Stack Role

After the library firmware has been updated on all of the libraries and the libraries have rebooted, you must return each library to its original library stack role.

To return the library stack role:

- 1 From the OCP, press **Setup** from the **Home** screen.

The OCP displays the **Setup** screen (see [figure 135](#)):

Figure 135 Setup Screen



- 2 From the **Setup** screen, use the up and down arrows to select **Cabinet** and press **Enter**.

The **Cabinet** screen displays (see [figure 136](#)):

Figure 136 Cabinet Screen

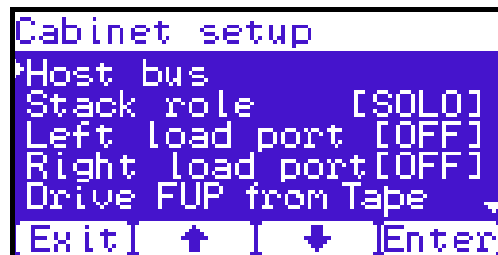

- 3 Use the up and down arrows to select **Stack role** and press **Enter**.

The **Stack role** screen displays.

- 4 Use the up and down arrows to select the appropriate stack role (**Master/Slave**) for this library and press **Enter**.

The system prompts you with one of the following confirmation screens asking:

- **Change to Master and reboot this system?**
- **Change to Slave and reboot this system?**

Note: If stack role is changed to **Master**, there will be an additional **Attention** screen that suggests the users to remove the old master if the current stand alone cabinet is added to an existing stack. Press **Ok** after confirmation.

- 5 Press **Yes**.

The library shuts down.

Note: If the stack role is changed to **Slave**, the Ethernet cable can be disconnected from cabinet's system controller board.

When all the libraries in the stack have been returned to their original stack role, power on all of the libraries and return to normal operation.

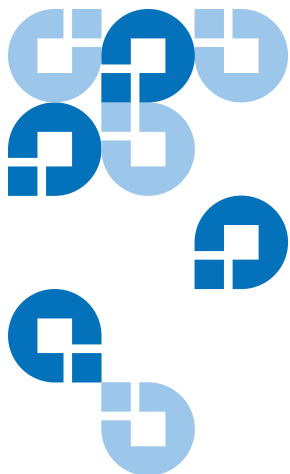

Regulatory Statements

This appendix provides the regulatory statements for the Quantum Scalar 50 libraries, in the following languages:

- English (page 208)
- Deutsch (seite page 238)
- Español (página page 240)
- Français (page page 243)
- Italiano (pagina page 245)
- Svenska (sidan page 247)
- 简体中文 (Simplified Chinese) (page 249)
- 繁體中文 (Traditional Chinese) (page 251)
- 日本語 (Japanese) (page 253)
- 한국어 (Korean) (page 255)

English

FCC Statement

This equipment has been tested and found to comply with the limits for a Class A digital device, pursuant to Part 15 of the FCC Rules. These limits are designed to provide reasonable protection against harmful

interference when the equipment is operated in a commercial environment. This equipment generates, uses, and can radiate radio frequency energy and, if not installed and used in accordance with the instruction manual, may cause harmful interference to radio communications.

Any changes or modifications made to this equipment may void the user's authority to operate this equipment.

Operation of this equipment in a residential area may cause interference in which case the user at his own expense will be required to take whatever measures may be required to correct the interference.

This device complies with Part 15 of the FCC Rules. Operation is subject to the following conditions:

- 1 This device may not cause harmful interference, and
- 2 This device must accept any interference received, including interference that may cause undesired operation.

Taiwan (BSMI) Statement

警告使用者:

這是甲類的資訊產品，在居住的環境中使用時，可能會造成射頻干擾，在這種情況下，使用者會被要求採取某些適當的對策。

Japan (VCCI) Statement

この装置は、クラスA情報技術装置です。この装置を家庭環境で使用すると電波妨害を引き起こすことがあります。この場合には使用者が適切な対策を講ずるよう要求されることがあります。

VCCI- A

DEN-AN Notice (Japan Industry Canada Digital Apparatus)

すべての電源コードが同じ定格電流を使用するとは限りません。同封されている電源コードを他の製品と一緒に使用しないでください。また、家庭用の延長コードをQuantum製品と一緒に使用しないでください。複数の電源コードを必要とする製品の電源を完全に切るには、システムに接続しているすべての電源コードを外してください。

Reference: *Interference-Causing Equipment Standard, ICES-003, Issue 2*

This Class A digital apparatus meets all requirements of the Canadian Interference-Causing Equipment Regulations.

CISPR-22 Warning!

This is a Class A product. In a domestic environment this product may cause radio interference in which case the user may be required to take adequate measures.

Notice for USA and CANADA Only

If shipped to USA, use the UL LISTED power cord specified below for 100-120 V operation. If shipped to Canada, use the CSA CERTIFIED power cord specified below for 100-120V operation.

Plug Cap	Parallel blade with ground pin (NEMA 5-15P configuration)
Cord	Type: SJT, three 16 AWG (1.5 mm ²) or 18 AWG (1.0 mm ²) wires
Length	Maximum 15 feet (4.5m)
Rating	Minimum 10 A, 125 V

Laser Statement

CAUTION: With all panels and enclosures in place, this product is rated as a Class I laser product.

CAUTION: Use of controls or adjustments or performance of procedures other than those specified herein may result in hazardous exposure.

Library Battery Statement

CAUTION: This product contains a Lithium battery. Lithium may be considered a hazardous material. Dispose of this battery in accordance with local, state, and federal laws. The Lithium batteries included in this product are:

- Panasonic BR1225
- IC Battery ST Micro M41T81

Battery Contained in Product:

“Perchlorate Material – special handling may apply, See www.dtsc.ca.gov/hazardouswaste/perchlorate.”

- The foregoing notice is provided in accordance with California Code of Regulations Title 22, Division 4.5 Chapter 33, Best Management Practices for Perchlorate Materials. This product/part includes a lithium battery which contains a perchlorate substance.

Deutsch

Regelungen der FCC

Nach Tests wurde festgelegt, dass dieses Gerät den digitalen Geräten der Klasse A entspricht und den Vorschriften in Abschnitt 15 der Regelungen der FCC unterliegt. Durch diese Vorschriften wird ein angemessener Schutz vor schädlichen Strahlungen gewährleistet, wenn dieses Gerät in einer kommerziellen Umgebung betrieben wird. Von den Geräten wird Hochfrequenzenergie erzeugt, genutzt und abgestrahlt, die bei einer im Widerspruch zu diesem Handbuch stehenden Installation oder Nutzung Funkstörungen erzeugen kann.

Änderungen und Modifikationen an diesem Gerät können zum Erlöschen der Betriebserlaubnis für dieses Gerät führen.

Der Betrieb dieses Geräts in Wohngebieten kann zu Empfangsstörungen führen, die der Verursacher auf eigene Kosten beheben muss.

Dieses Gerät erfüllt die Vorschriften in Abschnitt 15 der Regelungen der FCC. Der Betrieb unterliegt den folgenden Bedingungen:

- 1 Das Gerät darf keine schädlichen Störungen hervorrufen und
- 2 Das Gerät muss alle eingehenden Störungen aufnehmen, einschließlich Störungen, die einen unerwünschten Betrieb verursachen können.

Regelungen für Taiwan

警告使用者:

這是甲類的資訊產品，在居住的環境中使用時，可能會造成射頻干擾，在這種情況下，使用者會被要求採取某些適當的對策。

Industry Canada (Digital-Apparate)

Referenz: Norm für störungsverursachende Geräte, ICES-003, Ausgabe 2

Dieses Digitalgerät der Klasse A erfüllt alle Anforderungen der kanadischen Vorschriften bezüglich störungsverursachender Geräte (Canadian Interference-Causing Equipment Regulations).

CISPR-22 Warnung!

Dies ist ein Produkt der Klasse A. Dieses Produkt kann in Wohngebieten Funkstörungen verursachen, die vom Verursacher durch angemessene Maßnahmen behoben werden müssen.

Hinweis nur für USA und KANADA

Wenn dieses Produkt in die USA geliefert wird, muss das nachstehend für einen 100-120-Volt-Betrieb spezifizierte und von UL zugelassene Netzkabel verwendet werden. Wenn dieses Produkt nach Kanada geliefert wird, muss das nachstehend für einen 100-120-Volt-Betrieb spezifizierte und von CSA zugelassene Netzkabel verwendet werden.

Steckerausführung Parallele Steckzungen mit Erdungsstift
(NEMA 5-15P-Konfiguration)

Kabel Typ: SJT, drei 16 AWG (1,5 mm²)- oder
18 AWG (1,0 mm²)-Leiter

Länge Max. 15 Fuß (4,5 m)

Nennleistung Min. 10 A, 125 V

Laser-Erklärung

VORSICHT: Wenn alle Abdeckungen und Gehäuseteile korrekt angebracht sind, handelt es um ein Produkt der Laserklasse 1. Der Strichcodescanner in diesem Produkt ist jedoch ein Laser Klasse II. Vermeiden Sie die Aussetzung an die von dem Strichcodescanner ausgehenden Strahlen. Blicken Sie nicht direkt in den Strahl.

VORSICHT: Die unsachgemäße Verwendung von Bedienelementen oder Einstellungen bzw. die Ausführung von Arbeitsschritten, die nicht in der mit dem Gerät gelieferten Dokumentation beschrieben sind, können dazu führen, dass gesundheitsschädigende Strahlungen freigesetzt werden.

Hinweis zur Bibliotheksbatterie

VORSICHT: Dieses Produkt enthält eine Lithium-Batterie. Das nichtflüchtige RAM, Dallas Semiconductor DS1743-100, enthält eine Lithium-Batterie. Lithium ist eventuell als gefährliches Material zu betrachten. Die Entsorgung dieser Batterie muss unter Einhaltung aller lokalen, regionalen und bundesweiten Gesetze und Vorschriften erfolgen.

Español

Declaración FCC

Este equipo ha sido sometido a prueba y ha demostrado cumplir con los límites de un dispositivo digital de Clase A, conforme a la Parte 15 de las Normas FCC. Estos límites están diseñados para proporcionar una protección razonable contra las interferencias perjudiciales cuando el

equipo funciona en un entorno comercial. Este equipo genera, usa y puede emitir energía de radiofrecuencia y, si no se instala ni se usa de acuerdo con el manual de instrucciones, puede provocar interferencias perjudiciales para las comunicaciones de radio.

Cualesquiera cambios o modificaciones realizados a este equipo pueden anular la autoridad del usuario para utilizar este equipo.

El uso de este equipo en un área residencial puede provocar interferencias, en cuyo caso será el usuario quien tenga que correr con los gastos de las medidas que puedan ser necesarias para corregir las interferencias.

Este dispositivo cumple con la Parte 15 de las Normas FCC. El funcionamiento está sujeto a las siguientes condiciones:

- 1 Este dispositivo no debe causar interferencias perjudiciales, y
- 2 Este dispositivo debe aceptar cualquier interferencia que reciba, incluidas aquéllas que puedan provocar un funcionamiento no deseado.

Declaración para Taiwán

警告使用者:

這是甲類的資訊產品，在居住的環境中使用時，可能會造成射頻干擾，在這種情況下，使用者會被要求採取某些適當的對策。

Industria de Canadá (Aparato digital)

Referencia: *Interference-Causing Equipment Standard (Estándar para equipos que causan interferencia)*, ICES-003, Issue 2 (Tema 2)

Este aparato digital de Clase A cumple todos los requisitos de la normativa canadiense sobre equipos que causan interferencia.

Advertencia CISPR-22

Éste es un producto de Clase A. En un entorno doméstico, este producto puede causar interferencias de radio, en cuyo caso puede ser necesario que el usuario tome medidas adecuadas.

Aviso sólo para EE.UU. y CANADÁ

Si el producto se ha fabricado para EE.UU., utilice el cable de alimentación UL LISTED que se especifica más adelante para el funcionamiento a 100-120 V. Si el producto se ha fabricado para Canadá, utilice el cable de alimentación CSA CERTIFIED que se especifica más adelante para el funcionamiento a 100-120 V.

Enchufe Cuchilla paralela con patilla de conexión a tierra (configuración NEMA 5-15P)

Cable Tipo SJT, tres cables 16 AWG (1,5 mm²) ó 18 AWG (1,0 mm²)

Longitud Máxima de 15 pies (4,5m)

Clasificación Máximo 10 A, 125 V

Declaración sobre láser

PRECAUCIÓN: Con todos los paneles y cubiertas en su sitio, este producto se clasifica como un producto láser de Clase I. Sin embargo, el lector de código de barras que hay en el interior de este producto es un láser de Clase II. Evite la exposición a la luz del láser que emite el lector de código de barras. No mire fijamente el rayo.

PRECAUCIÓN: El uso de controles o ajustes o la realización de procedimientos distintos de los que se especifican en este manual pueden provocar una exposición peligrosa.

Declaración sobre la batería de la biblioteca

PRECAUCIÓN: Este producto contiene una batería de litio. La memoria RAM no volátil, Dallas Semiconductor DS1743-100, contiene una batería de litio. El litio puede ser considerado un material peligroso. Deseche la batería conforme a la norma vigente de aplicación local, del estado y federal.

Français

Déclaration de la FCC

Cet équipement a été testé et s'est révélé conforme aux limites d'un appareil numérique de Classe A, conformément à l'alinéa 15 de la réglementation de la FCC. Ces limites sont conçues pour fournir une protection adéquate contre les perturbations nuisibles lorsque l'équipement fonctionne dans un environnement commercial. Cet équipement génère, utilise et peut émettre une énergie à fréquence radio et risque, s'il n'est pas installé et utilisé conformément au manuel d'instruction, de créer des perturbations nuisibles aux services de radiocommunication.

Tout changement ou modification apporté à cet équipement risque d'annuler le droit d'utiliser l'équipement.

L'utilisation de cet équipement dans une zone résidentielle risque de créer des perturbations auxquelles l'utilisateur devra remédier à ses propres frais.

Cet appareil est conforme à l'alinéa 15 de la réglementation de la FCC. Le fonctionnement de cet équipement est soumis aux conditions suivantes :

- 1 Cet appareil ne peut générer de perturbations nuisibles et
- 2 Cet appareil doit accepter les perturbations reçues, notamment les perturbations qui risquent de générer un fonctionnement non souhaité.

Réglementation de Taïwan

警告使用者:

這是甲類的資訊產品，在居住的環境中使用時，可能會造成射頻干擾，在這種情況下，使用者會被要求採取某些適當的對策。

**Industrie Canada
(Appareil numérique)**

Référence : *Norme sur le matériel brouilleur, NMB-003, numéro 2*

Cet appareil numérique de Classe A satisfait à toutes les exigences des réglementations canadiennes sur le matériel brouilleur.

Avertissement CISPR-22 !

Ceci est un produit de Classe A. Dans un environnement résidentiel, ce produit risque de générer des perturbations radio auxquelles l'utilisateur doit peut-être remédier.

**Avis pour les États-Unis et
le Canada uniquement**

En cas d'envoi aux États-Unis, utilisez le câble d'alimentation CLASSÉ UL spécifié ci-dessous pour un fonctionnement à 100-120 V. En cas d'envoi au Canada, utilisez le câble d'alimentation CERTIFIÉ CSA spécifié ci-dessous pour un fonctionnement à 100-120 V.

Fiche Broche parallèle avec broche de mise à la terre
(configuration NEMA 5-15P)

Cordon Type : SJT, trois fils 16 AWG (1,5 mm²) ou
18 AWG (1,0 mm²)

Longueur 15 pieds (4,5 m) au maximum

Courant nominal 10 A au minimum, 125 V

**Réglementation relative
au laser**

ATTENTION : Avec tous les panneaux et enceintes en place, ce produit est classé comme un produit laser de Classe I. Le lecteur de codes-barres à l'intérieur de ce produit est, cependant, un laser de Classe II. Évitez toute exposition à la lumière laser émise par le lecteur de codes-barres. Ne fixez pas le faisceau des yeux.

ATTENTION : L'utilisation de commandes ou de réglages ou l'exécution de procédures autres que celles spécifiées ici peuvent entraîner une exposition dangereuse.

**Réglementation relative à
la pile de la bibliothèque**

ATTENTION : Ce produit comporte une batterie au lithium. La mémoire RAM non-volatile, Dallas Semiconductor DS1743-100, comporte une pile au lithium. Le lithium peut être considéré comme un matériau

dangereux. Mettez cette batterie au rebut conformément aux lois locales, nationales et fédérales.

Italiano

Dichiarazione FCC

Questa apparecchiatura è stata provata e trovata conforme ai limiti per i dispositivi digitali di Classe A, relativi alla Parte 15 delle norme FCC. Questi limiti sono concepiti per garantire un livello ragionevole di protezione da interferenze dannose quando l'apparecchiatura viene azionata in un ambiente commerciale. Questa apparecchiatura genera, utilizza e può irradiare energia a radiofrequenza e, se non installata e utilizzata secondo il manuale di istruzioni, potrebbe causare interferenze dannose alle comunicazioni radio.

Eventuali cambiamenti o modifiche apportati a questa apparecchiatura potrebbero invalidare il diritto dell'utente ad utilizzare questa apparecchiatura.

Il funzionamento dell'apparecchiatura in una zona residenziale potrebbe causare interferenze, nel qual caso l'utente dovrà a proprie spese prendere i dovuti provvedimenti per eliminare le interferenze.

Questo dispositivo è conforme alla Parte 15 delle norme FCC. Il funzionamento è soggetto alle seguenti condizioni:

- 1 Questo dispositivo non può causare interferenze dannose e
- 2 Questo dispositivo deve accettare eventuali interferenze ricevute, incluse le interferenze causate da funzionamento indesiderato.

Dichiarazione per Taiwan

警告使用者:

這是甲類的資訊產品，在居住的環境中使用時，可能會造成射頻干擾，在這種情況下，使用者會被要求採取某些適當的對策。

Industry Canada (apparati digitali)

Riferimento: *Interference-Causing Equipment Standard, ICES-003, 2.* edizione

Questo dispositivo digitale di Classe A è conforme a tutti i requisiti dei regolamenti canadesi per apparecchiature che causano interferenze.

Avvertenza CISPR-22!

Questo è un prodotto di Classe A. In un ambiente domestico questo prodotto potrebbe causare interferenze radio; in tal caso l'utente dovrà adottare tutti i dovuti provvedimenti.

Avviso esclusivamente per Stati Uniti e Canada

Se il prodotto viene spedito negli Stati Uniti, utilizzare il cavo di alimentazione elencato UL, specificato di seguito per il funzionamento a 100-120 V. Se il prodotto viene spedito in Canada, utilizzare il cavo di alimentazione certificato CSA, specificato di seguito per il funzionamento a 100-120 V.

Cappuccio della spina Lama parallela con perno di terra (configurazione NEMA 5-15P)

Cavo: Tipo: SJT, tre fili da 16 AWG (1,5 mm²) o 18 AWG (1,0 mm²)

Lunghezza Massima di 15 piedi (4,5 m)

Portata Minima di 10 A, 125 V

Dichiarazione sui dispositivi laser

ATTENZIONE: Con tutti i pannelli e le custodie in posizione, questo prodotto è classificato come prodotto laser di Classe I. Lo scanner per codici a barre all'interno del prodotto è invece un dispositivo laser di Classe II. Evitare l'esposizione ai raggi laser emessi dallo scanner per codici a barre. Non guardare fisso nel fascio di luce.

ATTENZIONE: L'utilizzo di comandi, regolazioni o procedure diversi da quelli specificati in questa sede potrebbe causare livelli di esposizione pericolosi.

**Dichiarazione sulla
batteria della libreria**

ATTENZIONE: Questo prodotto contiene una batteria al litio. La RAM non volatile, di tipo Dallas Semiconductor DS1743-100, contiene una batteria al litio. Il litio potrebbe essere considerato un materiale pericoloso. Smaltire la batteria secondo quanto previsto dalle leggi locali, regionali e nazionali.

Svenska

FCC-meddelande

Utrustningen har testats och befunnits uppfylla gränserna för en klass A digital enhet i enlighet med del 15 i FCC-reglerna. Gränserna är utformade att tillhandahålla rimligt skydd mot störningar när utrustningen används i en kommersiell miljö. Utrustningen alstrar, använder och kan utstråla radiofrekvent energi och kan, om den ej installeras och används i enlighet med instruktionshandboken, orsaka störningar i radiokommunikation.

Eventuella ändringar eller modifikationer av utrustningen kan ogiltigförklara användarens rätt att använda utrustningen.

Användning av utrustningen i bostadsområden kan orsaka störningar och i sådana fall måste användaren bekosta de åtgärder som krävs för att åtgärda störningarna.

Enheten uppfyller del 15 i FCC-reglerna. Användningen underkastas följande villkor:

- 1** Enheten får inte orsaka störningar och
- 2** enheten måste tåla mottagna störningar, inklusive störningar som kan orsaka önskad funktion.

Meddelande för Taiwan

警告使用者:

這是甲類的資訊產品，在居住的環境中使用時，可能會造成射頻干擾，在這種情況下，使用者會被要求採取某些適當的對策。

Kanada (digital utrustning)

Hänvisning: *Standard för störningsalstrande utrustning, ICES-003, utgåva 2*

Denna klass A för digital utrustning uppfyller alla krav i de kanadensiska föreskrifterna för störningsalstrande utrustning.

CISPR-22 Varning!

Detta är en klass A produkt. I en hemmiljö kan denna produkt orsaka radiostörningar, i vilket fall det kan krävas att användaren vidtar lämpliga åtgärder.

Meddelande för USA och KANADA enbart

Om utrustningen levereras i USA, använd den UL-listade nätsladden som specificeras nedan för användning med 100-120 V. Om utrustningen levereras i Kanada, använd den CSA-certifierade nätsladden som specificeras nedan för användning med 100-120 V.

Kontaktkåpa Parallellt blad med jordstift
(NEMA 5-15P-konfiguration)

Sladd Typ: SJT, tre 1,5 mm² (16 AWG) eller
1,0 mm² (18 AWG) ledare

Längd Maximalt 15 fot (4,5 m)

Märkvärde Minimalt 10 A, 125 V

Lasermeddelande

FÖRSIKTIGHET: Med alla paneler och luckor på plats klassificeras denna produkt som en laserprodukt klass 1. Streckkodsläsaren inuti produkten är klassificerad som en laserprodukt klass II. Undvik kontakt med streckkodsläsarens laserstråle. Titta inte in i strålen.

FÖRSIKTIGHET: Användning av kontroller, justeringar eller utförande av rutiner andra än de som anges i detta dokument kan leda till farlig exponering för strålning.

Meddelande om biblioteks batteri

FÖRSIKTIGHET: Produkten innehåller ett litiumbatteri. Det icke-flyktiga RAM-minnet, Dallas halvledare DS1743-100, innehåller ett litiumbatteri. Litium anses som riskavfall. Kasta batteriet i enlighet med lokala och nationella lagar.

简体中文 Simplified Chinese

FCC 声明

对此设备进行任何更改或修改都可能导致用户无权操作此设备。

此设备符合 FCC 规则第 15 部分的规定。操作时需符合以下条件：

- 1 此设备不会造成有害干扰，并且
- 2 此设备必须接受收到的任何干扰，包括可能导致非要求操作的干扰。

台湾声明

警告使用者:

這是甲類的資訊產品，在居住的環境中使用時，可能會造成射頻干擾，在這種情況下，使用者會被要求採取某些適當的對策。

加拿大工业部（数字设备）

参考：设备引起干扰标准，ICES-003 第 2 版

此 A 级数字设备符合《加拿大引起干扰设备规则》的所有要求。

CISPR-22 警告!

此为 A 级产品。在住宅环境中使用此产品时，可能会造成无线电干扰，在此情况下，用户需采取适当的措施。

仅限于美国和加拿大的声明

如果设备运往美国，请使用下面为 100-120 V 操作环境指定的 UL LISTE D 电源线。如果设备运往加拿大，~~仍~~使用下面为 100-120 V 操作环境指插头 CS 带接地脚的平行叶片（NEMA 5-15P 配置）

电源线 类型：SJT、三根 16 AWG（1.5 平方毫米²）或 18 AWG（1.0 平方毫米²）导线

长度 最长 4.5 米（15 英尺）

额定值 最小 10 A、125 V

激光声明

注意：所有面板和机壳均存在的情况下，此产品被列入 I 级激光产品。但是，此产品内的条形码扫描器是 II 级激光产品。请避免遭受条形码扫描器发出的激光辐射。请勿直视激光束。

1 级激光产品

注意：使用本产品时不指定的控制、调整或执行过程可能引发安全隐患。

库存机电池声明

注意

此产品包含锂电池。非易失性 RAM 采用 Dallas 半导体 DS1743-100，其中包含锂电池。锂电池为危险材料。处理此电池时应遵照三州、州和联邦的法律。

繁體中文 Traditional Chinese

FCC 聲明

此裝置經測試，符合 FCC 規則第 15 部份中對 A 級數位裝置的限制。這些限制旨在提供合理保護，防止該裝置工作於商業環境時產生有害干擾。此裝置產生、使用射頻能量，並可能輻射射頻能量，如果未根據說明手冊安裝和使用，可能會對無線電通訊造成有害干擾。

對此裝置進行任何變更或修改都可能導致使用者操作此裝置無效。在住宅區操作此裝置時可能會造成干擾，在此情況下，使用者需自行採取必要措施來糾正干擾。

此裝置符合 FCC 規則第 15 部份的規定。操作時需符合以下條件：

- 1 此裝置不會造成有害干擾，並且
- 2 此裝置必須接受收到的任何干擾，包括可能導致意外操作的干擾。

臺灣聲明

警告使用者:

這是甲類的資訊產品，在居住的環境中使用時，可能會造成射頻干擾，在這種情況下，使用者會被要求採取某些適當的對策。

加拿大工業部（數位裝置）

參考：引起干擾的裝置標準，ICES-003 第 2 次發行

此 A 級數位裝置符合《加拿大引起干擾裝置之規則》的所有要求。

CISPR-22 警告！

此為 A 級產品。在住宅環境中使用此產品時，可能會造成無線電干擾，在此情況下，使用者可能需採取適當的措施。

僅限於美國和加拿大的聲明

如果裝置運往美國，請使用下面指定的針對 100-120 V 操作環境的 UL LISTED 電源線。如果裝置運往加拿大，請使用下面指定的針對 100-120 V 操作環境的 CSA CERTIFIED 電源線。

插頭 帶接地針腳的平行葉片（NEMA 5-15P 設定）
電源線 類型：SJT、三根 16 AWG（1.5 平方公釐）或 18 AWG
 （1.0 平方公釐）導線

長度 最長 4.5 公尺

額定值 最小 10 A、125 V

鐳射聲明

1 級鐳射產品

注意：所有面板和機殼均在安全到位的情況下，此產品被列入 1 級鐳射產品。它是 1 級雷射器，其雷射器輸出是 1 級雷射器。雷射器是雷射器掃描器發出的鐳射光照射。請勿直視鐳射光束。

注意：使用本手冊中未指定的控制、調整或執行過程可能會導致危險。

媒體櫃電池聲明

注意

此產品包含鋰電池。非易失性 RAM 採用 Dallas 半導體 DS1743-100，其
此產品包含鋰電池。非易失性 RAM 採用 Dallas 半導體 DS1743-100，其
 邦的法律。

日本語 Japanese

FCC に関する記述

この装置はテスト済みであり、FCC ルール Part 15 に規定された仕様のクラス A デジタル装置の制限に適合していることが確認済みです。これらの制限は、商業環境で装置を使用したときに、干渉を防止する適切な保護を規定しています。この装置は、無線周波エネルギーを生成、使用、または放射する可能性があり、この装置のマニュアルに記載された指示に従って設置および使用しなかった場合、ラジオ/テレビの受信障害が起こることがあります。

この装置を変更または改造すると、この装置を操作するユーザー権が無効になることがあります。

住宅地でこの装置を使用すると、干渉を引き起こす可能性があります。その場合には、ユーザー側の負担で干渉防止措置を講じる必要があります。

この装置は FCC ルール Part 15 に準拠しています。動作は次の条件に従っていなければなりません。

- 1 当該装置によって、有害な干渉が発生することはない。
- 2 当該装置は、予想外の動作を引き起こす可能性のある干渉も含め、すべての干渉を受け入れなければならない。

台湾

警告使用者:

這是甲類的資訊產品，在居住的環境中使用時，可能會造成射頻干擾，在這種情況下，使用者會被要求採取某些適當的對策。

Industry Canada (デジタル機器)

参照：Interference-Causing Equipment Standard, ICES 002, Issue 2
このクラス A デジタル機器は Canadian Interference-Causing Equipment Regulations で定められている条件を満たします。

CISPR-22 警告

これはクラス A 製品です。国内で使用する場合、電波障害を引き起こす恐れがあります。適切な処置を行ってください。

アメリカ合衆国とカナダの通知

アメリカ合衆国に出荷した場合、100 ~ 120 V 以下での操作用に指定された UI 一覧の電源コードを使用してください。カナダに出荷した場合、100 ~ 120 V 以下での操作用に指定された CSA 認定の電源コードを使用してください。

プラグキャップ アースピン付き (NEMA 5-15P)
コードの種類：SJT、16 AWG (1.5 mm²) × 3 または
18 AWG (1.0 mm²) ワイヤ

長さ 最大 15 フィート (4.5m)

定格最低 10 A、125 V

레이저製品に関する記述

クラス I レーザー製品

注意：すべてのパネルとエンクロージャが定位置にある状態で、この製品はクラス I レーザー製品に相当してまいります。この製品の印刷バーコードはクラス II レーザーです。バーコードスキャナのレーザー光線との接触を避けてください。光線を見つめないでください。

注意：ここに指定された以外の方法で制御、調整、パフォーマンスを行った場合、危険な照射が起こることがあります。

ライブラリバッテリーに関する記述

注意

この製品にはリチウムバッテリーが入っています。不揮発性 RAM である Dallas Semiconductor DS1451/43-100 にはリチウムチップが含まれています。リチウムは危険性物質と見なされることがあります。このバッテリーを破棄するときは、地方、州、および連邦法に従ってください。

한국어 Korean

FCC 표시

이 장비는 FCC Rules 의 Part 15 에 의하여 테스트되고 Class A 디지털 장치에 대한 제한사항을 준수하는 것으로 검증되었습니다. 이 제한사항은 장비가 상업적 환경에서 작동할 때 해로운 간섭에 대해 적절히 보호되도록 고안되었습니다. 이 장비는 라디오 주파수 에너지를 생성, 사용 및 방출할 수 있고 지시사항에 따라 설치 및 사용되지 않는 경우 무선 통신에 해로운 간섭을 유발할 수 있습니다. 이 장비를 변경 또는 수정하는 경우 장비를 작동하는 사용자의 권한은 무효가 됩니다.

거주 지역에서의 장비를 작동하는 경우 간섭을 유발할 수 있으며, 이 경우 사용자는 자신의 부담으로 간섭을 정정하기 위해 필요한 모든 조치를 취해야 합니다.

이 장치는 FCC Rules 의 Part 15 를 준수합니다. 작동에는 다음 조건이 필요합니다.

- 1 이 장치는 해로운 간섭을 유발할 수 없으며, 또한
- 2 원하지 않는 작동을 유발할 수 있는 간섭을 포함하여 수신되는 모든 간섭을 수용해야 합니다.

대만 정책

警告使用者:

這是甲類的資訊產品, 在居住的環境中使用時, 可能會造成射頻干擾, 在這種情況下, 使用者會被要求採取某些適當的對策。

캐나다 산업 (디지털 장치)

캐나다 무선 장비 표준 ICES-003 Class A 이 Class A 디지털 장치는 캐나다 간섭 유발 장비 규정의 모든 요구사항을 충족합니다.

CISPR-22 경고 !

이것은 Class A 제품입니다. 국내 환경에서 이 제품은 사용자가 충분한 조치를 취해야 하는 무선 간섭을 유발할 수 있습니다.

유의사항 (미국 및 캐나다에만 해당)

미국으로 출시되는 경우 100-120 V 작동을 위해 아래에 지정된 UL LISTED 전원 코드를 사용하십시오. 캐나다로 출시되는 경우 100-120 V 작동을 위해 아래에 지정된 CSA CERTIFIED 전원 코드를 사용하십시오.

플러그 캡접지 핀이 부착된 병렬 전극 (NEMA 5-15P 구성)

코드 유형 : SJT, 3 선 16 AWG (1.5mm²) 또는 18 AWG (1.0mm²) 전선

길이 최대 4.5m (15 피트)

정격 최소 10A, 125V

레이저 표시

Class 1 레이저 제품

주의 : 모든 패널과 인클로우저가 제 위치에 있을 때 이 제품은 Class I 레이저 제품으로 평가됩니다. 그러나 이 제품 안에 있는 바코드 스캐너는 Class II 레이저입니다. 바코드 스캐너에서 방출되는 레이저 빛에 노출되지 마십시오. 빔을 바라보지 마십시오.

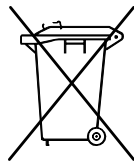

주의 : 여기에서 지정된 것을 제외한 절차를 제어, 조정 및 수행하는 경우 위험한 결과를 초래할 수 있습니다.

Disposal of Electrical and Electronic Equipment



This symbol on the product or on its packaging indicates that this product should not be disposed of with your other waste. Instead, it should be handed over to a designated collection point for the recycling of electrical and electronic equipment. The separate collection and recycling of your waste equipment at the time of disposal will help to conserve natural resources and ensure that it is recycled in a manner that protects human health and the environment. For more information about where you can drop off your waste equipment for recycling, please visit our website at: <http://qcare.quantum.com> or contact your local government authority, your household waste disposal service or the business from which you purchased the product.

Declaration of Conformity

Quantum	DECLARATION OF CONFORMITY According to EN45014
Manufacturer's Name:	Quantum Corporation
Manufacturer's Address:	141 Innovation Drive Irvine, CA 92617-3040 USA
Declares that the Product(s):	
Product Description	Automated Tape Library System
Product Name:	PX500 Series
Model Number(s):	PX502, PX506, PX510
Product Options:	All
Conforms to the following EC Directives and EC Standards:	
Low Voltage Directive 73/23/EEC	
Product Safety:	EN60950-1:2001, First Edition EN60825-1:1994, + A1, A2
EMC Directive 89/336/EEC	
EMC:	EN55022:1998, Class A EN61000-3-2:2000, Class A EN61000-3-3:1995 EN55024:1998 EN61000-4-2:1995 EN61000-4-3:2002 EN61000-4-4:1995 EN61000-4-5:1995 EN61000-4-6:1996 EN61000-4-8:1993 EN61000-4-11:1994
Authorizing Signature:	
	Date Issued: 08/29/2005
Linda Cheng Manager, Regulatory	
European Headquarters: 7 Lindenwood, Chineham Business Park Basingstoke, Hampshire RG24 8WD, United Kingdom Telephone: +44 (1) 256 848 713 Fax: +44 (1) 256 848 700	

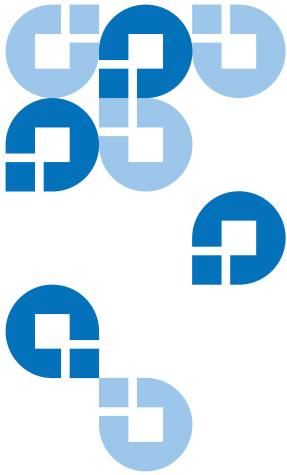

Glossary

B

back panel The panel at the back of the library that contains the connectors for attaching external cabling to the library.

bar code label The identification label on cartridges.

bar code scanner A laser device that is mounted on the robotic hand and reads the cartridge bar code labels.

C

calibration The software measurements and configuration required for successful operation of the library.

F

Fibre Channel Fibre Channel interface. This is a interface type used in native Fibre Channel tape drives.

FCC Class A Standard established by the U.S. Federal Communications Commission governing electromagnetic emissions.

FSE Field service engineer

G

GUI Graphical user interface. The browser based remote management system use to configure and control the Scalar 50 libraries.

H

host computer The computer that issues SCSI commands to control the library hand.

I	ISCI iSCSI is an IP-based standard for linking data storage devices over a network and transferring data by carrying SCSI commands over IP networks.
M	MTBF Mean Time Between Failures MTTR Mean Time To Repair
N	NVRAM Nonvolatile random access memory
O	off-line Library is offline and not able to communicate with a host. on-line Ready for communications with a host OCP Operator control panel.
P	pick The act of removing a cartridge from one location in preparation for placing it in another location. place The act of placing a cartridge in a location after it has been picked from another location. PROM Programmable read-only memory
R	RAM Random access memory
S	SCSI Small Computer System Interface. A communications standard for attaching peripheral equipment to small computers.
T	tape drive The mechanism that reads data from, and writes data to, a tape.
U	UL Underwriters Laboratories

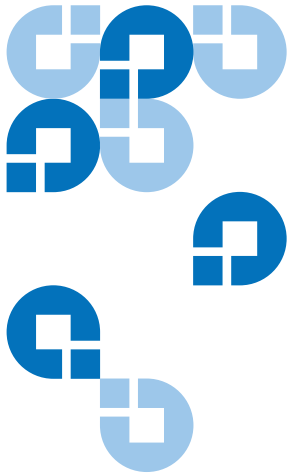

Index

A

auto clean 53

B

back panel 12
 CPCI card cage 11
 power supplies 11
 system controller board 11
 tape drives 12
backup
 configuration files 130
barcode label
 labeling LTO cartridges 27
browser, internet 64
BSMI (see Taiwan)

C

cabinet setup

 OCP 51
cable, SCSI, length 181
cabling routing for the Scalar 50 19
capacity on demand 13, 102
cartridges
 handling 182–183
 inspecting for damage 183–185
cleaning cartridges 28
COD 102
component test
 OCP 59
configuration files
 backup 130
 factory 130
 factory defaults 130
 restore 130
 restoring 130
 saving 130
configure slots 53
CPCI card cage 11
creating a library partition 105

D

date and time
 configuration 99
date and time setup
 OCP 56
deleting a library partition 108
DHCP
 enable from OCP 56
diagnostics
 OCP 57
disaster recovery 123
displayed frames 68
DLT-S4
 performance 5
DLTSage secure tape
 best practices 122
 tape migration 122
DLTSage tape security 113
drive firmware
 uploading 131
drive operations
 OCP 49

Index

pwr on/off 50
reset 50
drives page 83

E

editing a partition 107
emergency
 access 213
ESD precautions 23
event log 72
 viewing 73
event logs
 OCP 43

F

fa log file 133
factory defulats
 configuration files 130
failure analysis file 133
Fibre Channel
 ocp setup 52
find page 78
 barcode 79
 find media ID 79
 select map 80
find tapel
 OCP 47
Firefox 64
frames, displayed 68
front panel 8

G

getting started 18
guardian xxii

H

hardware information
 OCP 42
hardware status 71
health test 127
home screen 37
HP LTO-3
 performance 6
HP LTO-4
 performance 7

I

identification 86
info screen
 OCP 40
installing
 tape cartridges 21
internet browsers, supported 64
inventory page 82
IP address
 set from OCP 56
iSCSI bridge
 TC2201 92

J

Japan

class A regulatory statement 236
Java plug-in 64

K

key users 88
 create 88
 creating 88
 removing 89
 updating key user password 90

L

library
 back panel 12
 capacity on demand 102
 features 8-??
 front panel 8
 relocating 187
 setup 101
library access
 emergency 213
library doors
 open 22
library emulation 53
library firmware
 uploading 130
library operations
 OCP 45
 online/offline 46
 park for shipping 47
 release magazines 46
library partitioning
 cabinets 106
 configured slots 107

- creating 105
- deleting 108
- drives 106
- editing 107
- emulate P-Series 106
- emulate Scalar 50 106
- enable autoclean 106
- enable barcode swap 106
- load ports 106
- magazines 106
- partition name 106
- scsi logical unit (LUN) 106
- Library setup
 - emulation 53
- library setup
 - configure slots 53
- load port configuration 60
- logs 131
 - fa log 133

M

- magazines
 - release 46
 - removing 22
- maintenance 129
- mixed media 13
- move page 80
- move tape
 - OCP 48
- Mozilla Suite 64

N

- network configuration

- fields 95
- network information 93
- network setup
 - OCP 55

O

- OCP
 - buttons 38
 - components 38
 - home screen 37
 - info screen 40
 - operations screen 45
 - overview 37–38
 - problems 166
- OCP diagnostics screen 57
 - component tests 59
 - subsystem tests 58
 - system-level tests 58
- OCP info screen
 - event logs 43
 - hardware information 42
 - overview information 41
 - statistics information 43
- OCP LED status 171
- OCP operations screen
 - drive operations 49
 - find tape 47
 - library operations 45
 - move tape 48
 - scan inventory 50
- OCP setup screen 50
 - cabinet setup 51
 - date and time setup 56
 - network setup 55
 - partition setup 52

- security 54
- offline 46
- online 46
- online/offline
 - from remote management pages 126
 - from the OCP 37
- open library doors 22
- operating problems 168
- operations
 - accessing 77, 104
 - drives 83
 - find 78
 - inventory 82
 - move page 80
- operations screen
 - OCP 45
- overview information
 - OCP 41

P

- park for shipping 47
- partition setup
 - auto clean 53
 - barcode swap 53
 - OCP 52
- partitions
 - native Fibre Channel interface 103
 - requirements 103
 - setup 102
- power supplies 11
- power supply LEDs 175
- powering off 37
- problems
 - OCP 166

Index

- operating 168
- robotics 166
- start-up 165

Q

- Quantum LTO-3
 - performance 6
- Quantum LTO-4 HH
 - performance 7

R

- reference
 - web pages 134
- release magazines 46
- relocating
 - library 187
- removing magazines 22
- reset tape drive 50
- restore
 - configuration files 130
- robot
 - park for shipping 47
- robotics problems 166

S

- Scalar 50
 - cable routing 19
- scan inventory
 - OCP 50
- SCB
 - LEDs 171

- scb 11
- SCSI
 - cable length 181
- SCSI IDs 91
- SCSI II specification xx
- secure key 113
 - assign secure key to cartridge 117
 - backup secure key file 120
 - create secure key name/secure key pair 118
 - delete secure key name 119
 - enable/disable secure key for drives 116
 - protection mode for cartridges 115
 - select secure key for library 117
 - upload secure key file 121
- secure key migration 122
- secure tape
 - best practices 122
- secure users
 - remove 89
 - update 90
- security
 - OCP 54
- setup
 - accessing 85
 - date and time 99
 - events 95
 - identification 86
 - library 101
 - network 93
 - partitions 102
 - SCSI/Fibre 91
 - setup wizard 108
 - TC2201 bridge 92
 - user information 87

- setup wizard 108
- shipping
 - park robot 47
- SNMP traps 95
- start-up
 - problems 165
- statistics 73
- statistics information
 - OCP 43
- status 70
 - event log 72
 - hardware 71
 - overview 70
 - statistics 73
- storage care guardian xxii
- subsystem tests
 - OCP 58
- system controller board 11
 - LEDs 171
- system -level tests
 - OCP 58
- system tests 128
 - health tests 127

T

- Taiwan
 - class A regulatory statement 236
- tape cartridge
 - barcode labeling
 - LTO 27
 - loading 20
 - LTO
 - barcode labeling 27
 - SDLT
 - inserting 26

- write-protect switch 25
- tape cartridge migration scenario 123
- tape cartridge types
 - LTO 26
 - SDLT 24
- tape cartridges
 - handling 182–183
 - inspecting for damage 183–185
 - installing 21
 - key migration 122
- tape drive
 - details 72
 - reset 50
 - SCSI IDs 91
- tape drive LEDs 176
- tape drives 12
 - FC bridge 92
 - Fibre Channel OCP setup 52
 - iSCSI bridge 92
- tape magazines
 - removing 22
- tasks 133
- TC2201 92
- testing the email system 97
- tests
 - system 128
- traps
 - SNMP 95
- troubleshooting 164–169
 - OCP 166
 - operating 168
 - robotics 166
 - start-up 165
- turning the library off 37

U

- uploading
 - drive firmware 131
- uploading library firmware 130
- user information 87
- utilities
 - library 125
 - logs 131
 - maintenance 129
 - tasks 133

V

- VCCI (see Japan)

W

- Web pages
 - accessing 67
 - menu items 64
- web pages
 - using 67
- write-protect switch 25

