

adic

Intelligent Storage™

Scalar® Distributed Library Controller™ 2.6 Reference Guide

ADVANCED DIGITAL INFORMATION CORPORATION

Copyright © 2006 ADIC

The information contained in this document is subject to change without notice.

This document contains proprietary information which is protected by copyright. All rights are reserved. No part of this document may be reproduced, modified, distributed, or translated to another language without prior written consent of ADIC.

ADIC USA
11431 Willows Road NE
Redmond, Washington
98052-4952
Tel.: 1-800-336-1233
Fax: 1-425-881-2296

This document may describe designs for which patents are pending, or have been granted. By publishing this information, ADIC conveys no license under any patent or any other right.

ADIC shall not be liable for errors contained herein or for incidental or consequential damages (including lost profits) in connection with the furnishing, performance or use of this material whether based on warranty, contract, or other legal theory. ADIC makes no representation or warranty with respect to the contents of this document and specifically disclaims any implied warranties of merchantability or fitness for any particular purpose. Further, ADIC reserves the right to revise or change this document without obligation on the part of ADIC to notify any person or organization of such revision or change.

Every effort has been made to acknowledge trademarks and their owners. All trademarks within this document are the property of their respective owners. Trademarked names are used solely for identification or exemplary purposes, and any omissions are unintentional. ADIC is a registered trademark of Advanced Digital Information Corporation.

Published: May 2006

Document Number: 6-00658-03 Rev. A

Table of Contents

1 About This Guide and Your Product	1
Explanation of Symbols and Notes	1
Other Documents You Might Need	1
Getting More Information or Help	2

2 Description	3
System Description	3
Logical Library Concepts	4
PC System Requirements	5
Redundant Solution Requirements	6
Tape Library Requirements	7
Remote Browser Requirements	7
Graphical User Interface	8
Command Line Interface	8
Service and Maintenance Alerts	8

3 Configuration	9
Autostart Installation	9
Scalar DLC Management GUI	9
Resizing Windows and Panes	10
Browser Pre-Installation	11
Launch the Management GUI from a Browser	14
Launch the Management GUI as an Application	15
Configuration	16
Automatic Configuration	17
Manual Configuration	18
Advanced Configuration	18
Additional Configuration	23
Operating the Tape Library Doors	26
Managing the Database	27

4 Management GUI	29
Main Menu Bar	30

Screen Refresh Icon	31
Connection	31
Wizards	32
Extended Service	54
Help	60
GUI Tabs	61
Tabs Structure	68
GUI Log	69

5 Library Tab 71

Library	73
Library Properties	73
Library Diagnostics	74
Cartridges	76
Cartridge State	78
Home Position	79
Move Cartridge to Element	80
Drag and Drop Operations	81
Pool	82
Mailbox	84
Drives	85

6 Configuration Tab 87

Logical Tab	88
Library	89
Partition	93
Cartridge	94
Pool	97
Mailbox	99
Storage Slot	101
Mailbox Slot	102
Drive	104
Create Library	107
Assign Partition	108
Create Pool	109
Create Mailbox	110
Physical Tab	112
Library	113
Robot	118
Partition	119
Offline Cartridge	121
Storage Slots	124
Mailboxes	125
Drives	126
Create Partition	127
Users Tab	128
User	131
Create User	132
Clients Tab	134
DAS	135
DAS Client	135

Create DAS Client	144
SCSI	146
SCSI Client	147
Create SCSI Client	155
ROBAR	156
ROBAR Client	158
Create ROBAR Client	160
SCSI Target Tab	162
Port	164
Target	166
Logical Unit Number (LUN)	168
Create Target	169
Create LUN	170

7 Events Tab 173

Queue Tab	174
Monitoring Tab	176
Acknowledge Tab	178
History Tab	179
Rules Tab	179

8 Service Tab 183

Logs Tab	183
Command Log	184
Error Log	186
Diagnostic Tab	187
ATAC Calls Tab	189
Operator Panel Tab	195
Cluster Tab	198
SNMP Tab	199
Agents	200
Traps	201
Security	203

9 Tools and Utilities 205

Database Tool	206
Database Backup	207
Extended Mode	209
Database Compact	212
Database Restore	214
Database Save	216
SCSI Target Port Tool	217
Cluster Configurator Tool	219
Problem Report Tool	220
Log Viewer Utility	221
Trace Manager Utility	226
Trace Viewer Utility	230
Scalar DLC Software Licensing	232

Standard License	232
Cluster License	237

A Application Notes 239

Glossary	239
Element Addressing	244
Application Notes.	245
Media Types	246
Storage Types	247
Mailbox Types	248
Drive Types	249
Error Codes	251

B DAS Guide 259

System Description	259
Starting DAS Client Software	260
Commands Overview	260
Media Management.	260
DAS Management	260
Client Management	261
Scratch Pool Management	261
Define and Reserve.	261
DAS Commands	263

C SCSI Guide 267

Installation and Configuration	267
General Characteristics	268
SCSI Bus	269
SCSI Communications	270
SCSI Message System	271
SCSI Commands	272
SCSI Operations	274

D ROBAR Guide 277

Installation and Configuration	277
ROBAR Commands	278
ROBAR Command Format	280
Command Header	280
Command Structure	281
ROBAR Coordinates	283

Figures

Figure 1	Client Connection	4
Figure 2	Physical Libraries connected to the Scalar DLC	4
Figure 3	Partitions and Logical Libraries	5
Figure 4	Clients and Logical Libraries	5
Figure 5	About Scalar DLC	10
Figure 6	ADIC Scalar DLC Home Page	12
Figure 7	Tools and Utilities Page	13
Figure 8	Scalar DLC GUI Logon Dialog	14
Figure 9	Host Connection Window	15
Figure 10	Configuration Window	16
Figure 11	Management GUI	30
Figure 12	Main Menu Bar	30
Figure 13	Select Physical Library	33
Figure 14	Select Logical Library	33
Figure 15	Select Configuration Method	34
Figure 16	Select Media	35
Figure 17	Select Library Prototype	35
Figure 18	Select Mailbox	36
Figure 19	Select Client	36
Figure 20	Configuration Summary	37
Figure 21	Configuration Complete	38
Figure 22	Partitions Contained	38
Figure 23	Partitions Not Contained	39
Figure 24	Partition List	39

Figure 25	Partitions Summary	40
Figure 26	Ticket Registration	41
Figure 27	Ticket Priority and Description	41
Figure 28	Ticket Category	42
Figure 29	Ticket Device, Library, and Client	43
Figure 30	Ticket Service Code	44
Figure 31	Ticket Summary	45
Figure 32	Rule Name	50
Figure 33	Rule Event	50
Figure 34	Rule Event Location	51
Figure 35	Rule Notification Sent Dialog	51
Figure 36	Rule Notification Receiver	52
Figure 37	Rule Email Destination	53
Figure 38	Rule Email	53
Figure 39	Rule Summary	54
Figure 40	Registration Information	55
Figure 41	Connect to RMU	56
Figure 42	View Log: standard mode	57
Figure 43	View Log: advanced mode	58
Figure 44	Log Message Details	59
Figure 45	Scalar DLC Software Version Code	60
Figure 46	GUI Tabs: Working Areas	61
Figure 47	GUI Log	69
Figure 48	Library Controller	72
Figure 49	Library Properties	73
Figure 50	Library Diagnostics	74
Figure 51	Stop Current Test	75
Figure 52	Random Move: Select Media Type	75
Figure 53	Random Mount: Select Media Type	76
Figure 54	Cartridges	76
Figure 55	Multiple Mailbox Selection	77

Figure 56	Move Cartridge to Destination	80
Figure 57	Pool	82
Figure 58	Mailbox	84
Figure 59	Drives	85
Figure 60	Logical Controller	88
Figure 61	Logical Library Properties	89
Figure 62	Logical Library Resources	91
Figure 63	Logical Library Statistics	92
Figure 64	Logical Partition	93
Figure 65	Inventory Elements Range	94
Figure 66	Normal Cartridge	94
Figure 67	Foreign Cartridge	96
Figure 68	Pool	97
Figure 69	Assign/Unassign Cartridges to Pool	98
Figure 70	Mailbox	99
Figure 71	Assign/Unassign Slots to Mailbox	100
Figure 72	Storage Slot	101
Figure 73	Mailbox Slot	102
Figure 74	Drive Properties	104
Figure 75	Drive Statistics	106
Figure 76	Logical Library Creation	107
Figure 77	Partition Assign	108
Figure 78	Pool Creation	109
Figure 79	Mailbox Creation	110
Figure 80	Physical Controller	112
Figure 81	Physical Library Properties	113
Figure 82	Media Rules	115
Figure 83	Media Rule Creation	116
Figure 84	Apply Media Rule	117
Figure 85	Physical Library Statistics	117
Figure 86	Robot Online	118

Figure 87	Robot Offline	119
Figure 88	Physical Partition	120
Figure 89	Offline Cartridges	122
Figure 90	Offline Cartridge	123
Figure 91	Physical Storage Slots	124
Figure 92	Physical Mailboxes	125
Figure 93	Physical Drives	126
Figure 94	Partition Creation	127
Figure 95	User Controller	130
Figure 96	User	131
Figure 97	User Creation	132
Figure 98	DAS Interface Pane	135
Figure 99	DAS Client Properties	136
Figure 100	DAS Client Drives	138
Figure 101	Define Drives	140
Figure 102	DAS Client Volsers	141
Figure 103	Reserve/Define Volser Range	142
Figure 104	DAS Client Aliasing	143
Figure 105	DAS Client Creation	144
Figure 106	SCSI Pane	146
Figure 107	SCSI Client Properties	148
Figure 108	SCSI Client Mode	150
Figure 109	SCSI Client Drives	152
Figure 110	SCSI Client I/E Slots	153
Figure 111	SCSI Client Storages	154
Figure 112	SCSI Client Creation Properties	155
Figure 113	ROBAR Interface Pane	156
Figure 114	ROBAR Client Properties	158
Figure 115	ROBAR Client Creation	160
Figure 116	Port: SCSI	164
Figure 117	Port: Fibre Channel	165

Figure 118	SCSI Target	166
Figure 119	SCSI LUN	168
Figure 120	SCSI Target Creation	169
Figure 121	SCSI LUN Creation	170
Figure 122	Queue Tab	174
Figure 123	Monitoring Tab	176
Figure 124	Acknowledge Tab	178
Figure 125	History Tab	179
Figure 126	Rules Tab	180
Figure 127	Command Log	184
Figure 128	Email Data	185
Figure 129	Error Log	186
Figure 130	Diagnostic Tab	187
Figure 131	Diagnostic Description	188
Figure 132	ATAC Calls Tab	189
Figure 133	Start Repair	191
Figure 134	Repair	192
Figure 135	Fixed Problem Confirmation	193
Figure 136	Not Fixed Problem Confirmation	193
Figure 137	Repair History	194
Figure 138	Operator Panel Tab for the Scalar 10K	195
Figure 139	Operator Panel Tab for the Scalar 1000	197
Figure 140	Cluster Tab	198
Figure 141	SNMP Agents	200
Figure 142	SNMP Service Configuration: Trap Destination	202
Figure 143	SNMP Security	203
Figure 144	SNMP Service Configuration: Security	204
Figure 145	Log On Dialog	206
Figure 146	Database Backup	207
Figure 147	Backup Schedule Dialog	208
Figure 148	Database Extended Mode Dialog	209

Figure 149	Backup Log Schedule Dialog	210
Figure 150	Database Compact Dialog	212
Figure 151	Compact Schedule Dialog	213
Figure 152	Database Restore Dialog (by backup)	214
Figure 153	Database Restore Dialog (restore from device)	215
Figure 154	Database Save Dialog	216
Figure 155	SCSI Target Port Tool	217
Figure 156	Advanced Port Settings	218
Figure 157	Cluster Configuration Utility: no configuration	219
Figure 158	Cluster Configuration Utility: configuration complete	219
Figure 159	Problem Report Tool	220
Figure 160	Log Viewer Main Window	221
Figure 161	Log Viewer: Command Tracking	222
Figure 162	View Event	222
Figure 163	Result Description	224
Figure 164	Search	224
Figure 165	Goto Event	224
Figure 166	Logging Options	224
Figure 167	Filtering Options	225
Figure 168	Viewing Options	225
Figure 169	Trace Manager Main Window	226
Figure 170	Group Level	227
Figure 171	Class Level	227
Figure 172	Add Object	228
Figure 173	Add Existing Object	228
Figure 174	Object Level	228
Figure 175	Start Tracing	229
Figure 176	Tracing Options	229
Figure 177	Trace Viewer Main Window	230
Figure 178	View Trace Record	231
Figure 179	Licensing Dialog	232

Figure 180	About License	233
Figure 181	License Request File	233
Figure 182	Licensing Review	234
Figure 183	Send License via Email	235
Figure 184	Licensing Before Installation	235
Figure 185	Authorization String	236
Figure 186	Time-based License	236
Figure 187	Finishing License	237
Figure 188	Element Addressing (single-aisle library)	244
Figure 189	Element Addressing (dual-aisle library)	245

Tables

Table 1	SCSI and Fibre Channel Adapters	6
Table 2	Required Firmware Version	7
Table 3	Scalar DLC Service State	10
Table 4	Scalar DLC Home Page Name	11
Table 5	Management GUI Default Users	14
Table 6	Object name limitations	16
Table 7	Wizard Buttons	32
Table 8	Event Specification	45
Table 9	Tree Objects	62
Table 10	Logical Library States	63
Table 11	Physical Library States	64
Table 12	Robot States	64
Table 13	Partition Class and State	65
Table 14	Storage Slots	65
Table 15	Mailbox Slots	66
Table 16	Drive Slots	67
Table 17	Element Properties: Icons	67
Table 18	Operational Buttons	68
Table 19	Cartridge States	78
Table 20	User Access Level	128
Table 21	User Rights	129
Table 22	SCSI Target Icons	162
Table 23	SCSI and Fibre Channel Adapter Target-LUN Settings	163
Table 24	Event Classes	176

Table 25 Event Data	177
Table 26 Database Archive	216
Table 27 Log Viewer Operations	223
Table 28 Terms	239
Table 29 Element Mapping (Single-aisle libraries)	244
Table 30 Element Mapping (Dual-aisle libraries)	245
Table 31 Media Types	246
Table 32 Storage Types	248
Table 33 Mailbox Types	248
Table 34 Drive Types	249
Table 35 Error Codes	251
Table 36 Usage of Define and Reserve	261
Table 37 Media Management	263
Table 38 DAS Management	264
Table 39 Client Management	265
Table 40 Scratch Management	265
Table 41 ROBAR Commands	278
Table 42 Command Header format	280
Table 43 Command format	281
Table 44 ROBAR Coordinates	283

About This Guide and Your Product

This manual contains reference information and instructions for configuring and operating the Scalar Distributed Library Controller (Scalar DLC) software. This guide is intended for customers and administrators who use the Scalar DLC software.

Explanation of Symbols and Notes

The following symbols appear throughout this document to highlight important information.



WARNING

INDICATES A POTENTIALLY HAZARDOUS SITUATION WHICH, IF NOT AVOIDED, COULD RESULT IN DEATH OR BODILY INJURY.



CAUTION

Indicates a situation that may cause possible damage to equipment, loss of data, or interference with other equipment.



Note

Indicates important information that helps you make better use of your system.

Other Documents You Might Need

The following documents are also available for this product. These documents can be found on the product CD or at www.adic.com/manuals:

- *Scalar DLC Installation Guide*
- *Scalar DLC Release Notes (6-00335-xx)*
- *DAS Administration Guide (6-00345-xx)*
- *DAS/ACI Interfacing Guide (6-00346-xx)*
- *Scalar 10K SCSI Reference Guide*
- *Scalar 1000 SCSI Reference Guide*

- *SCSI Primary Commands 2 (SPC-2)*
- *SCSI Primary Commands 3 (SPC-3)*
- *ROBAR Interfacing Guide*
- *Scalar 10K Operator Guide*
- *Scalar 1000 Operator Guide*
- *RMU Reference Guide*

Getting More Information or Help

More information about this product is available on the Customer Service Center website at www.adic.com/csc. The Customer Service Center contains a collection of information, including answers to frequently asked questions (FAQs). You can also access software, firmware, and drivers through this site.

For further assistance, or if training is desired, contact ADIC:

ADIC Technical assistance center (ATAC) in the USA:

800-827-3822

ADIC Technical assistance center (ATAC) in Europe and Japan:

00-800-9999-3822

For additional contact information:

www.adic.com/contact

To open a Service Request:

www.adic.com/techsup

2

Description

This chapter provides an overview of the Scalar DLC software that supports the Scalar 1000 and Scalar 10K (single- and dual-aisle) tape libraries.

The sections contained are:

- [System Description](#) on page 3 provides the description of Scalar DLC system.
- [Graphical User Interface on page 8](#) briefly describes the main administration tool of the Scalar DLC software.
- [Command Line Interface](#) on page 8 provides an information about command line interface.
- [Service and Maintenance Alerts](#) on page 8 describes the alert features of the Scalar DLC.

System Description

The Scalar DLC software runs as a service under Windows 2000/2003. It serves as a centralized library management tool that simplifies and automates the tracking and management of all system resources for optimal performance and maximum availability. The Scalar DLC software provides network and System Administrators with a Java-based interface that allows library monitoring from anywhere on the Web.



Note If a firewall is being used, outside access by Web browsers might be denied.

The Scalar DLC also allows administrators to select parameters that define which library events provide notifications to customers and ADIC Technical Assistance Center (ATAC) via email and, sometimes, the Simple Network Management Protocol (SNMP) alerts.

The main working tool of the Scalar DLC software is the Management GUI. Refer to [Graphical User Interface on page 8](#). This tool executes all the actions of management and configuration.

The Scalar DLC provides the connectivity between the library and the customer (client). The connection type depends on client configuration. See [Figure 1 on page 4](#).

Figure 1 Client Connection

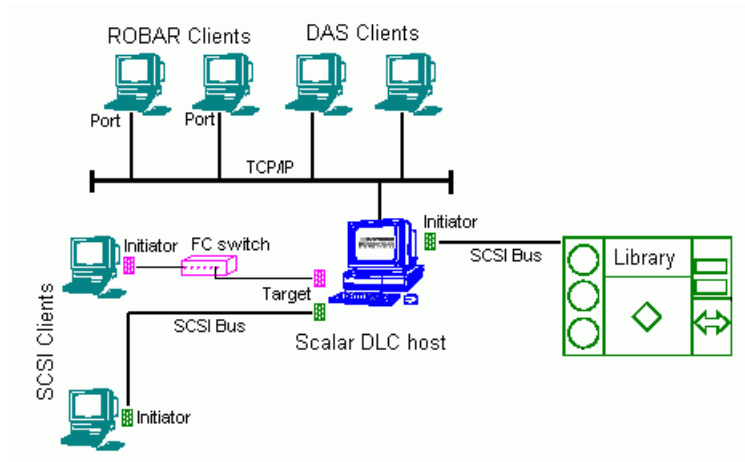

The Scalar tape libraries are connected to the Scalar DLC software host via the SCSI bus or the Fibre Channel cable. See [Figure 2](#).

Figure 2 Physical Libraries connected to the Scalar DLC

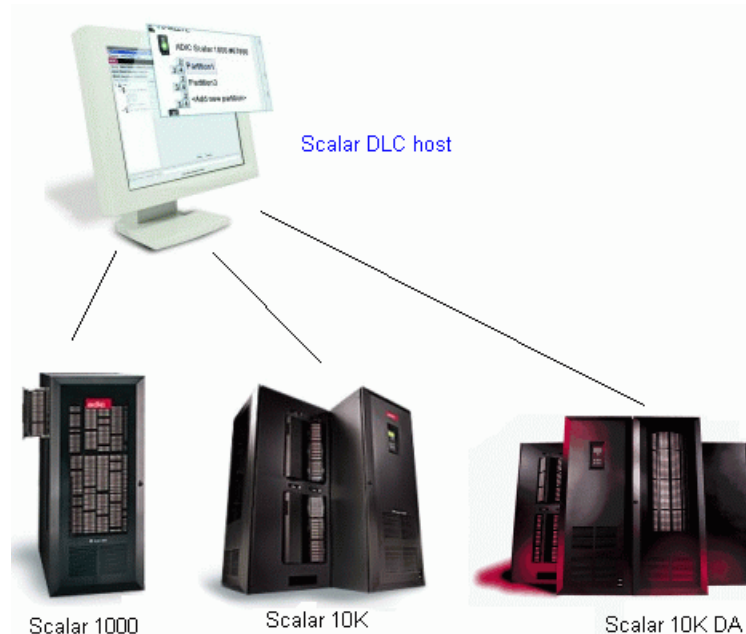

For each tape library found during **Scan SCSI Bus** operation, the Scalar DLC software creates an object called *physical library*. This object represents all aspects of the real tape device.

Logical Library Concepts

In order for clients to have a flexible way to share common resources (*physical library*), the Scalar DLC uses virtual objects called *logical libraries* to represent the real device for the client. The Management GUI is used to create and configure these logical libraries. The connection between the logical library and the device is implemented by means of the partitioning features that are unique to the Scalar DLC software. The partitioning operation creates a number of element ranges called *partitions* that are used by the physical library. These ranges are then assigned to the logical libraries (see [Figure 3](#) on page 5) so that the client who uses a certain logical library can access the correct part of the physical library. This feature is very useful when clients use a single physical library while the client has access to only a certain resource. The logical library represents these resources, and the assigned partitions provide a connection between the logical library and its physical equivalent.

This logical library concept is based on a partition containing the continuous range of elements of a single type (for example, storage) and media domain (for example, DLT). The partitions cannot overlap; however, a single partition can be assigned to two or more logical libraries. In that case, two logical libraries will have a shared area, and the clients of the first library can access this area as well as the clients of the second library.



CAUTION

Sharing the single partition between two or more logical libraries may cause access problems, so this feature must be used with extreme caution.



Note

The partition cannot contain both storage tower and storage shelf elements, even if they consist of the identical storage slots (for example, Generic DLT). This means for the single-media library with a storage tower (for example, Scalar 10K), no less than two storage partitions should be created in order to cover its storage area completely; the first partition will cover the tower, and the second will cover the linear storage (storage shelves).

Figure 3 Partitions and Logical Libraries

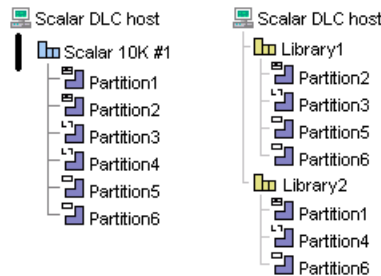

Two or more clients either of the same type (for example, DAS-based) or of different types (for example, DAS-based and ROBAR-based) may use a single logical library. This means that they have rights to use common resources that are part of this library (cartridges, drives, and so forth). See [Figure 4](#).

Figure 4 Clients and Logical Libraries

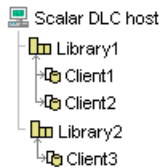

PC System Requirements

The minimum PC system hardware requirements are based on Microsoft PC 2000 System Design Guide Specifications. The following list summarizes the Scalar DLC system requirements:

Required:

- 800 MHZ or faster Inter Pentium™ or equivalent CPU (minimum 4 free PCI slots in chassis)
- 256K L2 Cache
- 256 MB RAM
- Dual matched Hard Drives (10GB or more)
- CD RW
- 3.5" Diskette Drive

- 15" or greater SVGA Display
- NT/2000 compliant SCSI adapter
- Standard keyboard and mouse
- Windows 2000 SP4 or Windows 2003 pre-installed

Optional:

- SCSI target HBA LSI 20860, LSI 8751D, and/or LSI 8951U
- Fibre Channel target HBA QLogic 2200F-33 and/or QLogic 23xxF

Refer to [Table 1](#) for a description of SCSI and Fibre Channel adapters that can be used in the system.

Table 1 SCSI and Fibre Channel Adapters

Adapter	Type	Connection (external)	Max cable length, m
LSI 20860	SCSI	50-pin high density SE	5
LSI 8751D	SCSI	68-pin high density HVD	25
LSI 8951U	SCSI	68-pin very high density LVD/SE	12(LVD), 5(SE)
QLA 2200	Fibre Channel	SC duplex multi-mode	-
QLA 23xx ^a	Fibre Channel	Small form factor multi-mode optic LC	-
Local ^b	SCSI	-	-

a. 'xx' means 00, 10, 40, and 42. No other models are currently supported.

b. The driver is designed by ADIC to execute the SCSI backup applications right on the Scalar DLC server PC. No SCSI/FC hardware is required.

Redundant Solution Requirements

The Scalar DLC Redundant (failover) solution is provided using the Microsoft Cluster service. The user has a shared disk with the Scalar DLC database and two hosts with the installed components of Scalar DLC software; for redundancy reasons, one host is online and the other is offline. If an error occurs and the online host goes offline, the other host turns online immediately, so the customer even does not notice a problem with the host. The customer engineer can repair the problem host without stopping the Scalar DLC software.

The Scalar DLC Redundant solution is based on Microsoft Cluster service. The special requirements are:

- Two PCs, each meeting the standards described in [PC System Requirements on page 5](#).
- Microsoft Windows 2000 Advanced Server or Windows 2003 Server installed on each PC.
- Microsoft Cluster Service installed on each PC.
- For each PC, there should be a minimum of two disk controllers. The two disk controllers do not need to be the same type. For example, using on-board IDE and SCSI is acceptable.
- At least one external (shared) RAID disk. The disk partition should have NTFS formatting.
- RAID adapter (on each PC) to access a shared disk.



CAUTION

The Scalar DLC failover solution in a redundant configuration requires the Windows 2000 Advanced Server or Windows 2003 Server operating system. By default, this system is configured without password protection for network access. So ADIC strongly urges companies using this product to use all customary procedures to protect Scalar DLC servers from external threats.

For the details about Scalar DLC Redundant solution, refer to the *Scalar DLC Installation Guide*.

Tape Library Requirements

The library firmware and hardware requirements are described in this topic.

Operating mode

For the Scalar 1000 library, the following operating modes are supported:

- Native
- EXABYTE compatibility
- Storage Technology compatibility
- EMASS compatibility

For the Scalar 10K library only *native* mode is supported.

For the Scalar 10K DA (dual-aisle) library:

- Both medium changers (aisles) must run in *native* mode.
- Both medium changers (aisles) must operate in non-compressed mode.
- At the time of the first configuration, both medium changers (aisles) must be in the *online* state. *Ready* state is not required.



CAUTION

The Scalar DLC software may not work properly if the tape library operates in the unsupported mode.

Additionally, for the libraries with towers (Scalar 10K and Scalar 10K DA):

- At the time of the first configuration all towers (if any) must be in the *library (online)* state.

Firmware Version

Make certain the firmware version of each tape library meets the Scalar DLC requirements ([Table 2](#)).

Table 2 Required Firmware Version

Tape Library	Required Firmware	Comment
Scalar 1000	641A or later	If the current version is 2.3 or earlier, contact ATAC. A customer engineer will upgrade the library with the appropriate firmware version.
Scalar 10K	300A or later	
Scalar 10K DA	300A or later (for both robots)	

Remote Browser Requirements

The Scalar DLC Management GUI takes advantage of very advanced Java2 features that are not supported by all browsers. The browser updates can be initiated from the Scalar DLC software splash page by selecting the *Tools and Utilities* tab. Refer to [Figure 7](#) on page 13 and [Browser Pre-Installation](#) on page 11.

Graphical User Interface

The Scalar DLC software GUI (also called Management GUI) is based on Web browser technology that guarantees a consistent user interface across all UNIX and Windows platforms. The GUI is available to users, system administrators, and customer engineers. The Management GUI consists of the following components:

- Main Menu bar
- GUI Tabs
 - Library tab
 - Configuration tab
 - Events tab
 - Service tab
- GUI Log

Each component is covered in detail in the following chapters.

Command Line Interface

The command line interface is supported by the DAS version 3.12 SP2 application. The DAS interface supports numerous third party software applications.

Additional information about DAS is contained on this CD-ROM in the *DAS Administration Guide* document.

Service and Maintenance Alerts

The Scalar DLC software monitors all system resources and automatically notifies the ADIC Technical Assistance Center (ATAC) whenever a service call is required. The information supplied to ATAC includes:

- Error detection
- Event logging and tracing
- Error recovery

Notification is generated by means of applications in the following list:

- GUI Messenger
- Email Home
- Call Home
- SNMP

Each component is covered in detail in the following chapters.

3

Configuration

This chapter provides information about logical configuration of the Scalar DLC system for the customer.

 **Note** Local administrator rights are required to install the Scalar DLC software and all required components.

The sections are:

- [Autostart Installation](#) on page 9 describes the installation order.
- [Scalar DLC Management GUI](#) on page 9 contains information on launching the Management GUI.
- [Configuration](#) on page 16 describes the configuration order.

Autostart Installation

To launch the autostart program, load the CD-ROM in the CD-ROM drive. If the autostart program does not launch, use the *Run* option from the **Start** button on the task bar to execute the *autorun.exe* program.

For a description of the installation process, refer to *Scalar DLC Installation Guide*.

 **Note** The Adobe Acrobat Reader version 4.0 or later is required to view the documentation in PDF format. Download the most recent version of the software from the Adobe Web site at <http://www.adobe.com>.

Scalar DLC Management GUI

The Scalar DLC Management GUI is started by either the browser-launched applet or the supervisory desktop application. Before using any of them, determine that the Scalar DLC service is running.

 **Note** Before starting the Management GUI, verify that the display resolution setting is 800 x 600 pixels or higher and the display color setting is more than 256 colors

To check the service state (refer to [Table 3](#) on page 10), examine either the **Control Panel > Services** or the task bar.

Table 3 Scalar DLC Service State



Task Icon	Description
	The Scalar DLC supervisor service is <i>stopped</i> (<i>Offline</i> for the Scalar DLC Cluster solution). Double click the icon to display Figure 5 .
	The Scalar DLC supervisor service is <i>started</i> (<i>Online</i> for the Scalar DLC Cluster solution). Double click the icon to display Figure 5 .
	The Scalar DLC supervisor service is either <i>starting</i> or <i>stopping</i> (<i>turning online/offline</i> for the Scalar DLC failover solution).

Figure 5 About Scalar DLC



The *About* dialog shows the version of installed Scalar DLC software and its internal components. All Scalar DLC hot fixes and service packs (if any) are enlisted here, too.

Resizing Windows and Panes

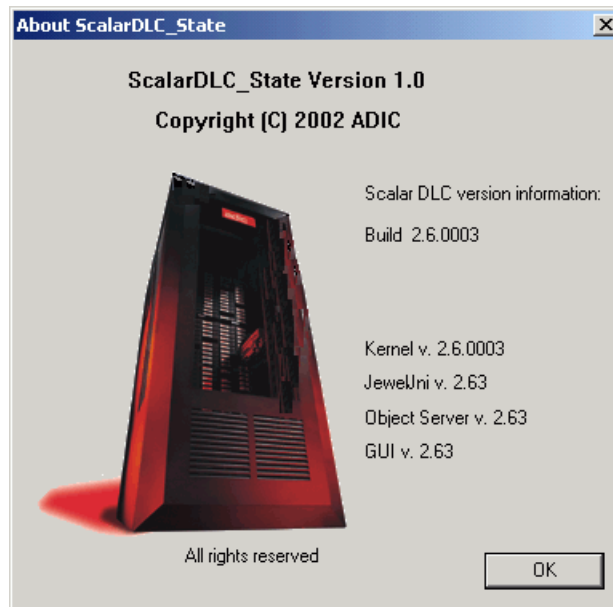
Some Management GUI panes contains data that cannot fit into the standard screen string (for example, long names of SCSI Adapter objects, or partitions), or a long list of properties that would be useful to see all in one screen without scrolling. Especially for such cases both the browser-based and application-based Management GUI allow you to modify the size of the main Scalar DLC window screen as well as to resize some internal Scalar DLC panes.

 **Note** Do not reduce the Scalar DLC screen below its original size.

Browser Pre-Installation

Both Netscape Navigator™ and Internet Explorer™ browsers must be updated by installing the Java Plug-in, as described in [Java Plug-In](#) on page 14, to take full advantage of the Scalar DLC Management GUI. For a remote browser, the update is required before the browser can launch the Scalar DLC software. For a local browser, the update could be executed manually; but it is best practice to install the browser(s) before launching the Scalar DLC software installation. The update steps should be executed by either a system administrator or an expert PC user.



Note

The Internet Explorer browser is a required component for the Scalar DLC software installation. If Internet Explorer is not present, the Scalar DLC CD autorun program installs Internet Explorer as a part of the Scalar DLC Installation process. No pre-installation is required for a complete installation.

Start the update procedure by entering the Host name location of the Scalar DLC software server on the browser address line (for example, **http://computer**). This establishes a connection with the Scalar DLC software home page. Refer to [Table 4](#) and [Figure 6](#) on page 12.



CAUTION

If the Scalar DLC software is installed with SSL support (refer to the *Scalar DLC Installation Guide*), always use **https:// instead of **http://**.**

Table 4 Scalar DLC Home Page Name

Name / ID	Value (example only)	Explanation
DNS host name	computer	The host network name used in DNS.
Cluster name	sdllcluster	The cluster virtual name (redundant solution only), refer to the <i>Scalar DLC Installation Guide</i> .
DNS address	192.168.1.14	The host network IP address, refer to the <i>Scalar DLC Installation Guide</i> .
Cluster DNS address	192.168.1.10	The virtual cluster IP address (redundant solution only), refer to the <i>Scalar DLC Installation Guide</i> .

Figure 6 ADIC Scalar DLC Home Page

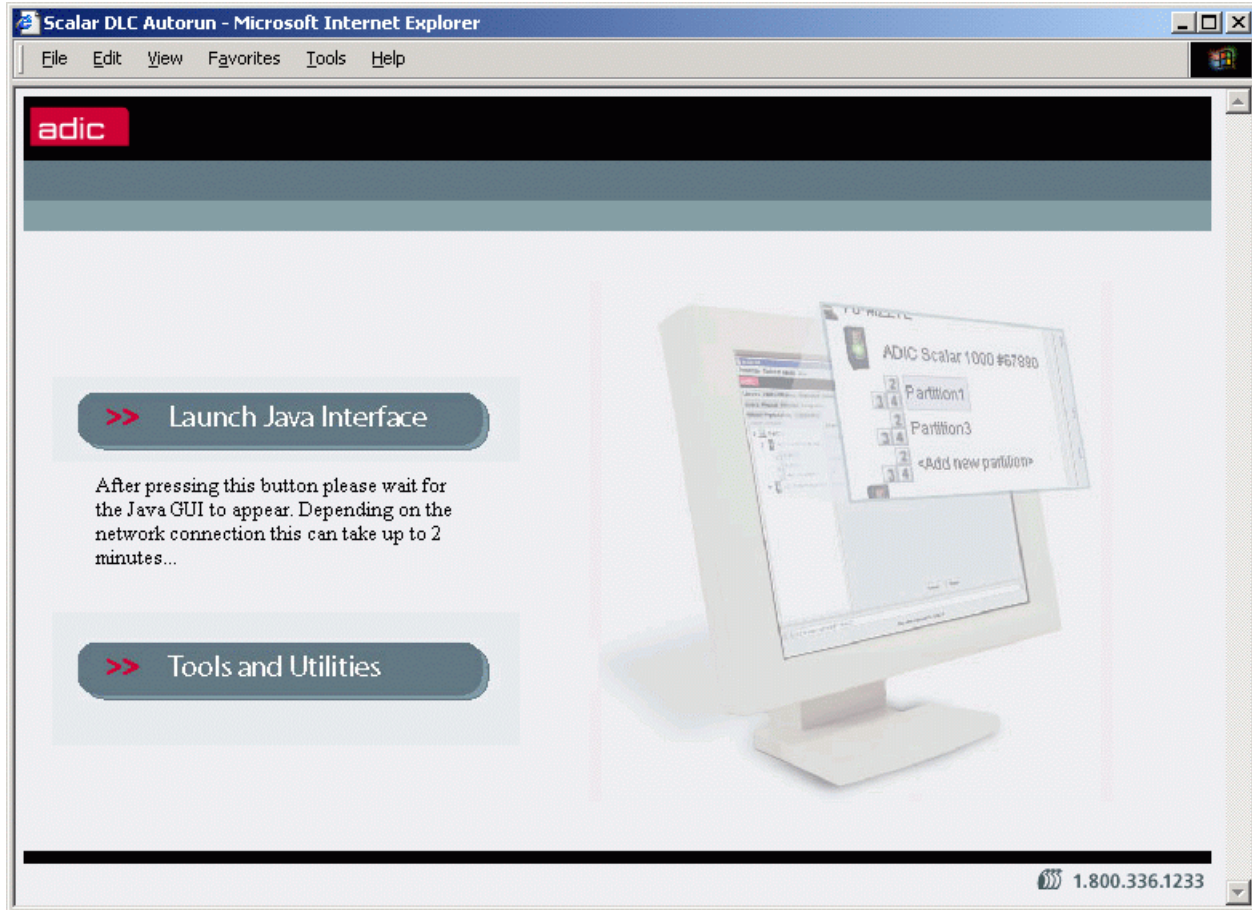

The only required component for the browser update is a Java Plug-in. Click the **Launch Java Interface** button when it appears. Refer to [Java Plug-In](#) on page 14 for the description of update process.

Selecting the **Tools and Utilities** tab displays the Tools and Utilities pane (see [Figure 7](#) on page 13).

Figure 7 Tools and Utilities Page

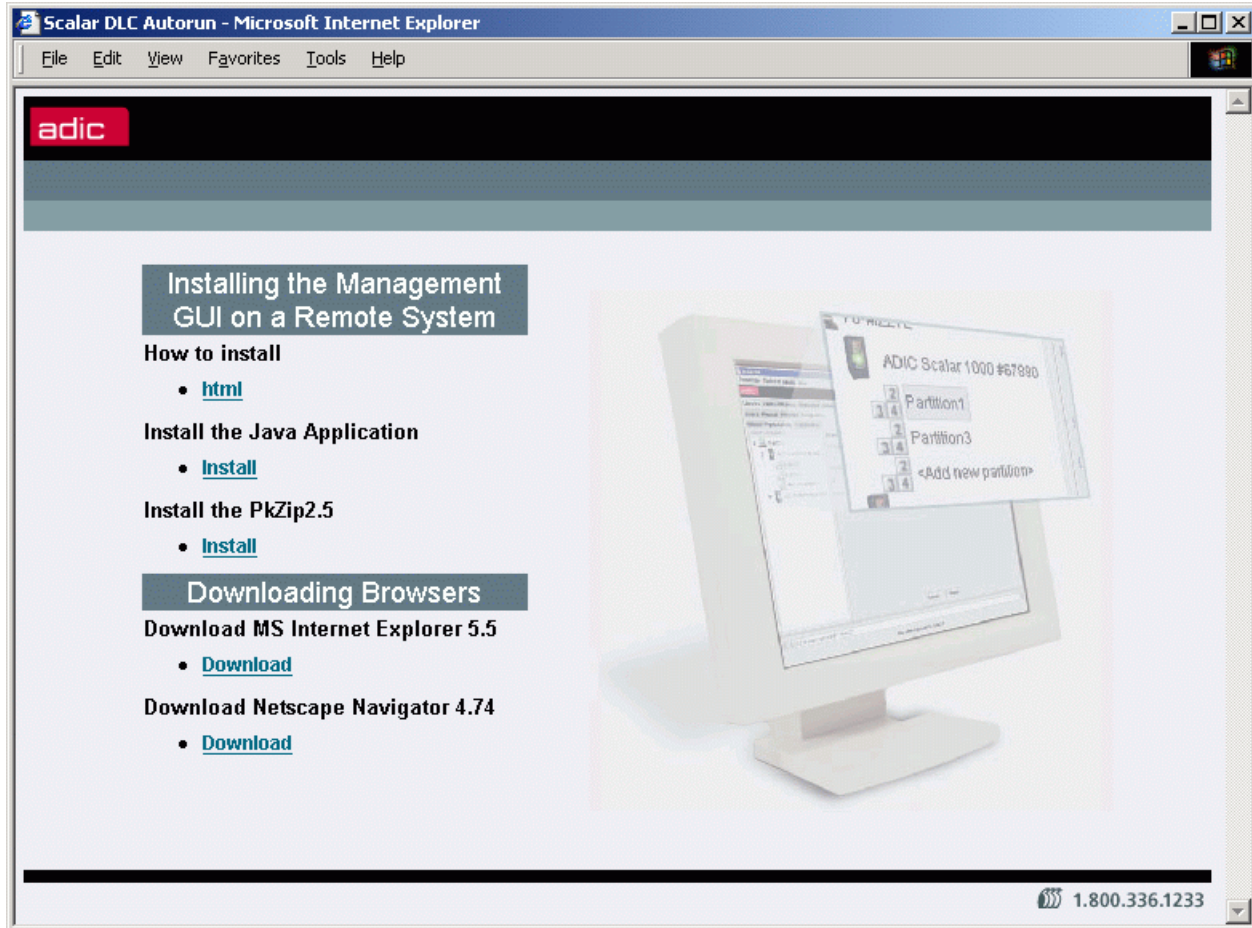

The latest required versions of both Netscape Navigator™ and Internet Explorer™ browsers can be downloaded from this page.

 **Note** Do not download the browser unless your browser version (always shown under Help > About) is *lower* than required.

The Scalar DLC Management GUI that is designed to launch the Scalar DLC software application from a remote host can be downloaded also. The installation steps of the Scalar DLC Management GUI are described on this page as well.

Remote Management GUI

The Java-based GUI software is used as a Scalar DLC management tool. It is always installed on the Scalar DLC server, however the same software can be downloaded from server and launched from a remote host as well.

From the Tools and Utilities page (see [Figure 7](#)) click on "Install Java Application" and download the zip archive containing all files for the remote Management GUI. The "How to install" link contains the complete instruction on how to install the package and launch the application.

Also download and install the Java Plug-In, as described in [Java Plug-In](#) on page 14.

Java Plug-In

When running versions of Netscape Navigator prior to version 4.7, the Scalar DLC Management GUI requires the Java 2 plug-in 1.4.2_09 release. Installing the plug-in enables direct Java2 applets to run while using Sun's JRE (Java Remote Environment). Therefore, the *j2re-1_4_2_09-windows-i586-p.exe* file must be executed so that files are added to a specific directory.

Begin the procedure by selecting the hyperlink associated with the Java Plug-in. Save the file to a temporary directory and then launch it.

The same update procedure should be executed when the Management GUI is used with the remote Scalar DLC host.



Note

The Java plug-in patch is also required for both the Microsoft Internet Explorer and Netscape Navigator browsers when the user desires to use the applet-based GUI (refer to [Launch the Management GUI from a Browser](#) on page 14) rather than application-based ([Launch the Management GUI as an Application](#) on page 15).

However, the MS IE browser installs the Java plug-in patch automatically when the browser-based Management GUI is launched for the first time.

The Netscape Navigator browser needs to be updated manually.

Launch the Management GUI from a Browser

Enter the Hostname location of the Scalar DLC server on the browser. This procedure establishes a connection with the Scalar DLC home page. See [Figure 6](#) on page 12.



Note

Disk write operations (upload) are not allowed from the browser-launched Scalar DLC Management GUI due to security restrictions.

When the Scalar DLC home page appears, press the **Launch Java Interface** button. The Scalar DLC Logon dialog window appears (see [Figure 8](#)).

Figure 8 Scalar DLC GUI Logon Dialog

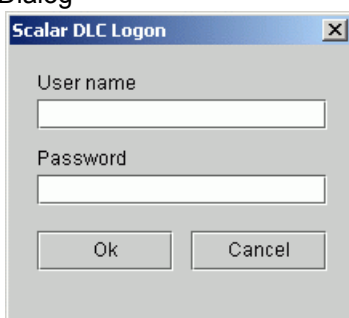

The default login settings are shown in [Table 5](#).

Table 5 Management GUI Default Users

Default user name	Default password	Access level
admin	password	Admin (administrator)
atac	guardian	CE (customer engineer)

**CAUTION**

Because of security reasons it is strongly recommended to change the default admin and CE passwords after the configuration is complete.

For the details on user access level and settings refer to [Users Tab](#) on page 128.

Firewall and Proxy Issues

If the Scalar DLC Management GUI starts but can not connect to the Scalar DLC server, a firewall or proxy server could be present between the browser and the Scalar DLC server. The remote methods invocation transport layer normally attempts to open a direct socket connection to the host on the Internet. However, many intranets have firewalls or proxies that do not allow this procedure.

The Management GUI cannot communicate with the Scalar DLC software server through a firewall if port 1099 is not open. Connections also are easier to make if the browser is not configured to use a proxy. If necessary, contact the System Administrator to resolve any connectivity issues.

Launch the Management GUI as an Application

From the Windows desktop, launch the Scalar DLC Manager shortcut (**Start > Programs > ADIC Distributed Library Controller > Scalar DLC Manager**, or double-click on the **Scalar DLC Manager** desktop icon) to enable the host connection window (see [Figure 9](#)).

The operation can be executed either from local host where the Scalar DLC software is installed or from a remote host after installing the Management GUI, as described in [Remote Management GUI](#) on page 13.

Figure 9 Host Connection Window

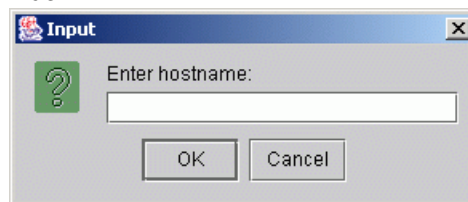

Enter the Scalar DLC hostname in the dialog window. Then the Scalar DLC log on dialog appears. See [Figure 8](#) on page 14.

**Note**

Disk write operations (upload, download) are allowed from the application-based Scalar DLC Management GUI.

Configuration

When a user is logged into the Management GUI and no previously configured physical library has been found, a configuration selection pane opens automatically (see [Figure 10](#)); if the configuration has been performed, this pane will not appear. Choose the configuration method.

Figure 10 Configuration Window

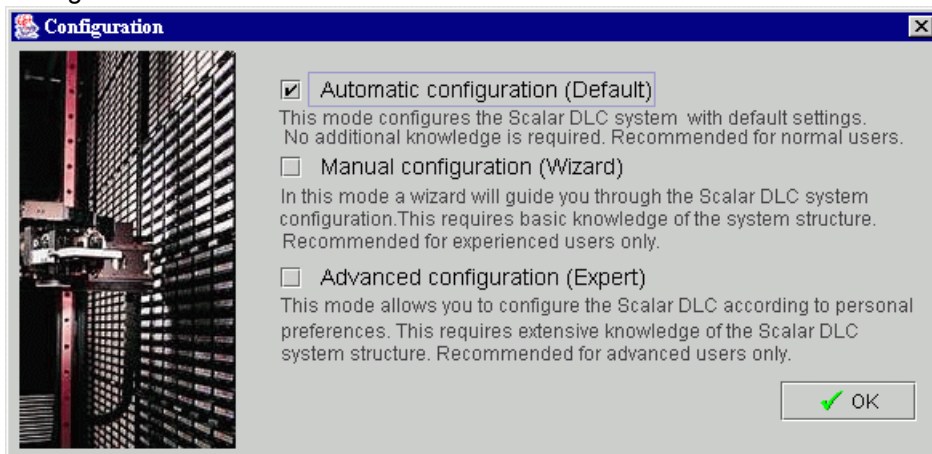

Either accept the default configuration or select the desired configuration method.

- [Automatic Configuration](#) on page 17 is recommended for the first-time users that have no experience in configuring the Scalar DLC system.
- Wizard-based [Manual Configuration](#) on page 18 is recommended for the users with basic knowledge about the configuration of the Scalar DLC.
- [Advanced Configuration](#) on page 18 is designed for the advanced users that have enough experience to perform all configuration manually.
- After the basic configuration is finished, an [Additional Configuration](#) on page 23 could be performed.

Some client interfaces have certain limitations concerning the names of used objects, for example, some DAS-based applications do not recognize the mailbox name for **Insert** command other than **lxx** (xx means any two alphanumeric characters). To avoid such issues, be sure that the objects created and configured by means of the Scalar DLC Management GUI are named as shown in the [Table 6](#).



Note

Some customer (client) applications do not understand the capitalization difference (A and a), the others do not. ADIC recommends using the common alpha-model (either capitals or small letters in all object names).

ADIC also strongly does not recommend using spaces (" "), underscores ("_"), hyphens ("-") and other symbols in the object names. Even when the Scalar DLC Management GUI permits this, the client application may not recognize the appropriate object.

Table 6 Object name limitations

Object	GUI Manager	DAS / ACI	ROBAR	SCSI
Host	40 an ^a , a first	40 an, a first	An	None
Logical library	30 an, a first	None (absent)	None (absent)	None

Table 6 Object name limitations (Continued)

Object	GUI Manager	DAS / ACI	ROBAR	SCSI
Partition	30 an, a first	None (absent)	None (absent)	None
Client	80 an, a first	80 an, a first	80 an, a first	None
Scratch pool	30 an, a first	16 an, a first	None (absent)	None
Clean pool	30 an, a first	16 an, a first	Paa	None
Data cartridge, volser	30 an	16 an (6 recommended)	6 an	None
Cleaning cartridge, volser	30 an	16 an (CL + 4 an recommended)	CL + 4 an	None
Mailbox area, eject operations	30 an, a first	3 an, Enn recommended	Enn	None
Mailbox area, insert operations	30 an, a first	3 an, Inn recommended	Inn	None
Drive	40 an, a first	30 an ^b (9 an, a first recommended)	Dnn	None

a. alphanumeric; "a" means "alpha" (A-Z), "n" means "numeric" (0-9).

b. Only for DAS ACI ver. 3.12 and higher.

Automatic Configuration

ADIC recommends the automatic configuration for typical or first time users. Using the automatic configuration, create a default Scalar DLC configuration for each detected physical library.

The automatic configuration creates the configuration by executing the following procedures:

- Step 1** Scans the SCSI bus for physical libraries.
- Step 2** Creates partitions for all the physical library elements.
- Step 3** Creates a logical library.
- Step 4** Assigns all created partitions to the logical library making it a representation of the whole physical library.
- Step 5** For the logical library, creates two identical mailboxes (I01 and E01) that include all the mailbox slots.
- Step 6** Creates a client and assigns it to the logical library.



Note

By default, if the DAS Client support is installed, the created client is the DAS Client; if not, no client can be created because the SCSI and ROBAR interfaces need certain pre-configuration.

Manual Configuration

For advanced users, the wizard-based configuration automatically scans for libraries and creates physical library objects by executing the following step-by-step procedures:

- Step 1** Scans the SCSI bus for physical libraries.
- Step 2** Creates partitions for all the physical library elements.
- Step 3** Creates a logical library. The library name can be specified. Also refer to [Table 6](#) on page 16.
- Step 4** Assigns the partitions to the logical library. It is possible to select a method of assignment: single-media library, single-robot library, and the complete library selection are available for the first-time manual configuration.
- Step 5** Creates two identical mailboxes covering all the mailbox slots. The mailbox names can be specified. Also refer to [Table 6](#) on page 16.
- Step 6** Creates a client and assigns it to the logical library. The client name can be specified. Also refer to [Table 6](#) on page 16.



Note

By default, if the DAS Client support is installed, the created client is the DAS Client; if not, no client can be created because the SCSI and ROBAR interfaces need certain pre-configuration.

Refer also to [Create Configuration](#) on page 32 for the detailed description of steps.

Advanced Configuration

ADIC recommends this mode for expert or administrator users. In this mode, only the icon associated with the Scalar DLC software system appears.

To enable all the Management GUI functions, create a working configuration by performing the procedures in the following sections:

Rescan SCSI Bus

Create the device objects associated with a physical library by using the **Rescan SCSI Bus** button on the **Configuration > Physical > Controller** pane. Refer to [Physical Tab](#) on page 112.

Create Partitions

Create the partition objects representing desired parts of the Physical Library. That can be done on **Configuration > Physical > Library** pane (**Add new Partition** button). Refer to [Create Partition](#) on page 127.



Note

There should be at least three partitions created for each physical library: storage, I/E, and drive. Refer to [Partition](#) on page 119 for the details.

The partition properties can be modified later, even after the partition is assigned to a logical library, via the **Configuration > Physical > Partition** pane. Refer to [Partition](#) on page 119.

Create a Logical Library

Create a logical library. That can be done on the **Configuration > Logical** pane (**Add new Library** button). Refer to [Create Library](#) on page 107.

Immediately after creation, the logical library is shown as *Invalid*. That is correct: *Invalid* state indicates that the library does not contain a proper set of partitions.

Assign Partitions to a Library

Assign the previously created partitions to the new logical library. That can be done through the **Configuration > Logical > Library** pane (**Assign new Partition** button) or *Assign Partitions* wizard in **Main Menu > Wizards** section. Refer to [Assign Partition](#) on page 108 or [Assign Partitions](#) on page 38.



Note

There should be at least three partitions assigned to each logical library: storage, I/E, and drive. The partition can be shared between two or more logical libraries. Refer to [Partition](#) on page 93 for details.

The partitions can also be assigned or unassigned at a later time.

Create Mailbox

Create one or more mailboxes for a logical library. They will represent its insert/eject areas. This can be done through the **Configuration > Logical > Library** pane (**Add new Mailbox** button). Refer to [Create Mailbox](#) on page 110.



Note

Although Management GUI does not have name restrictions for the mailbox name, some backup applications do have them. Refer to [Table 6](#) on page 16.

The mailbox name and assigned range of insert/eject slots also can be changed later through the **Configuration > Logical > Mailbox** pane (**Add/Remove new Slots** button). Refer to [Assign Slots to Mailbox](#) on page 100.

Create Client

Create the client object(s) that will represent the customer(s) that will work with the library. Depending on the interface used, the clients are DAS Clients, SCSI Clients, or ROBAR Clients. Some clients may share a single logical library.



CAUTION

Setting up the SCSI client to share the logical library with any DAS- or ROBAR-based client may cause problems in the work of the client application. Both DAS and ROBAR interfaces do have the same concept of the cartridge home position (refer to [Home Position](#) on page 79) but the SCSI does not because it uses only 'move' commands.

DAS

The DAS Client can be created via the **Configuration > Clients > DAS** pane (**Add new Client** button). Refer to [Create DAS Client](#) on page 144.

SCSI

The SCSI Client can be created via the **Configuration > Clients > SCSI** pane (**Add new Client** button). Refer to [Create SCSI Client](#) on page 155.

Note that the Target and LUN objects must be created before via the **Configuration > SCSI Target > Port** pane (**Add new Target** button), and **Configuration > SCSI Target > Port > Target** pane (**Add new LUN** button). Refer to [Create Target](#) on page 169 and [Create LUN](#) on page 170.



Note

It is strongly recommended to create Targets and LUNs as a continuous range of elements starting from 0 (Target0, Target1, Target2, etc.; LUN 0, LUN1, etc.).

ROBAR

The ROBAR Client can be created via the **Configuration > Clients > ROBAR** pane (**Add new Client** button). Refer to [Create ROBAR Client](#) on page 160.

Note that the ROBAR Port must be configured before the clients can send commands (refer to [ROBAR](#) on page 156).

Initialize the Logical Library

The library must be initialized for its internal elements and cartridges to be created. It can be done by using the **Inventory** button. The same command can be done via the client interface.

Once the initialization process is completed, the library functions are available.

Assign Drives to Cartridges

After the cartridges are created, they may be assigned to the appropriate drives for use by the **Generic mount** operation. This will use the assigned drive as the first position in the list of possible mount destinations. A cartridge can be assigned to one and only one drive, but the drive can be assigned to multiple cartridges.

The assignment executes (and can be changed later) through the **Configuration > Logical > Cartridge** pane (Cartridge properties > Assigned Drive >> Save changes). Refer to [Cartridge](#) on page 94.



Note

This optional feature is not required for SCSI or ROBAR clients, but some DAS clients do use it.

Inserting New Media

After adding new cartridges to the library through the mailbox always execute **Import (insert)** operation (either via client interface or in Management GUI) before starting actually using the new media. The cartridge that was not inserted can not receive the valid home position (refer to [Home Position](#) on page 79), and thus a lot of basic functions will be not available.



Note

The Home Position feature is not used by SCSI clients, but for DAS and ROBAR the home position (home slot, home address) is a part of their conceive.

Assigning a home position via import/insert operation is sometimes the only way to put the cartridge in the correct logical library.

Example: two libraries (Library1 and Library2) with two different clients (Client1 and Client2) have non-shared storage areas and a shared I/E area. The cartridge that should be accessed by Client2 is put to the shared mailbox. Client2 (or Admin from GUI in the Library2) must execute the import/insert operation so the cartridge will go to the storage area of Library2. But if the Client1 launches the import operation first, the cartridge will go to the Library1 and become not accessible for the Client2.

Create Scratch Pool

Create the required scratch cartridge pools for a logical library. The *scratch* pools should contain the data cartridges ready for writing. That can be done through the **Configuration > Logical > Library** pane (**Add new Scratch Pool** button). Refer to [Create Pool](#) on page 109.



Note

Although Management GUI does not have name restrictions for the pool name, some backup applications do have them. Refer to [Table 6](#) on page 16.

In the same dialog it is possible to add data cartridges to the new pool (**Assign/Unassign** button). Refer to [Assign Media to Pool](#) on page 98.



CAUTION

Sharing a single data cartridge between two or more scratch pools is not allowed.

The pool name and assigned cartridge range can be changed later through the **Configuration > Logical > Pool** pane. Refer to [Pool](#) on page 97. Some DAS and ROBAR clients may also assign cartridges to the existing pool as well as remove them.



Note

It is possible to create pools before **Inventory**, but the cartridges will appear in the library only after it is initialized.

Mark Cleaning Cartridges

After the Inventory is performed, the logical library recognizes all cartridges that it contains. However, the library cannot say which cartridge is of *data* type (readable and writable data carrier), and which is of *cleaning* type (the tool used for drive cleaning). By default, all cartridges are recognized as *data*, so it is up to Admin to mark the correct cartridges as *cleaning*.

This can be done through the **Configuration > Logical > Cartridge** pane (Cartridge properties > Type (data/clean) >> Save changes). Refer to [Cartridge](#) on page 94.

If the cartridge is marked as cleaning by mistake, and in fact it is data, change its type back the same way.



Note

The type of cartridges that are already assigned to the scratch or clean pool cannot be changed.

Create Clean Pool

Create the required clean pools for a logical library. The *clean* pools should contain the cleaning cartridges ready to perform drive cleaning operations. That can be done through the **Configuration > Logical > Library** pane (**Add new Clean Pool** button). Refer to [Create Pool](#) on page 109.



Note

Although Management GUI does not have name restrictions for the pool name, some backup applications do have them. Refer to [Table 6](#) on page 16.

In the same dialog it is possible to add cleaning cartridges to the new pool (**Assign/Unassign** button). Refer to [Assign Media to Pool](#) on page 98.

**CAUTION**

Sharing a single clean cartridge between two or more cleaning pools is allowed. Watch however the state of that cartridge with extreme caution.

The pool name and assigned cartridge range can be changed later through the **Configuration > Logical > Pool** pane. Refer to [Pool](#) on page 97. Some DAS and ROBAR clients may also assign cartridges to the existing pool as well as remove them.

**Note**

The cartridges appear in the library during **Inventory**, but only Admin can mark the cartridge as *cleaning*, as described in [Mark Cleaning Cartridges](#) on page 21. Also the 'insert cleaning cartridges to pool' operation can be executed via DAS by DAS Client.

Configure Clean Manager

After the cleaning pools are created and configured, they can be assigned to the appropriate drives for the drive cleaning operation. Cleaning can be executed either automatically or by client request. This can be done via the **Configuration > Logical > Drive** pane (Drive properties > Cleaning). Refer to [Drive](#) on page 104. Specify the correct cleaning time according to the drive type and model. Specify also the cleaning rate (the number of mounts between cleanings).

Configure Aliasing

Some DAS Clients use old versions of backup application that cannot correctly recognize the newest models of media and drives, but must work with such models nevertheless. To fix this issue, Scalar DLC provides an Aliasing feature.

Using **Configuration > Clients > DAS > DAS Client** pane > **Aliasing** (refer to [Aliasing](#) on page 143) for either drive or media (or both) select the alias that the backup application 'understands' instead of its default type that the application cannot recognize. Then press **Save** button to update the client properties. The Scalar DLC restart is not required, the client application restart is not required, too.

**Note**

This feature is optional and used only by some DAS clients.

Reserve Drives and Cartridges

Some DAS clients may reserve the drives and the cartridges which means no one but the client will access the appropriate resource.

**CAUTION**

The drives and cartridges reserved/allocated by Client1 cannot be accessed by other clients. The allocation must be removed before the other client can access the reserved resource.

Removing the allocation made by another client is also possible from the client side by the special command (allocd, allocv) if the client has Supervisor privileges.

Enter the appropriate values through the **Configuration > Clients > DAS > DAS Client** pane (Reserved Drives > (Select Drive) >> Reserve; Reserved Volsers >> Add Volserrange, Remove Volserrange). Refer to [Drives](#) on page 138 and [Reserve or Define Volsers](#) on page 142. Also the customer may perform a reserve operation by using the special commands (**allocd**, **allocv**) from the client side.



Note

This feature is optional and used only by some DAS clients.



Note

Using the Management GUI Admin can execute any operation whether the used medium and/or drive is reserved or not.

Also Admin can remove the allocation, either through **Configuration > Clients > DAS > DAS Client** pane (Reserved Drives >> Specify >> Save changes; Reserved Volsers >> Add Volserrange, Remove Volserrange), or through **Configuration > Logical > Drive** (Drive properties > Owner >> None >> Save changes) and **Configuration > Logical > Cartridge** (Cartridge properties > Owner >> None >> Save changes).

Define Drives and Cartridges

Some DAS clients may define the drives they will use and the cartridges they may access.



CAUTION

The drives and cartridges defined by Client1 are in common use, but the Client1 itself can access only the *defined* drives and media. 'None defined' means the Client1 can use all drives and all media in the library it is assigned to.

Define the appropriate values through the **Configuration > Clients > DAS > DAS Client** pane (Defined Drives >> Specify >> Save changes; Defined Volsers >> Add Volserrange, Remove Volserrange). Refer to [Define Drives](#) on page 140 and [Reserve or Define Volsers](#) on page 142. Also the customer may perform a temporary define operation by using the special command (**scop2**) from the client side.



Note

This feature is optional and used only by some DAS clients.

Configure Additional Libraries

Follow the sequence of the previous procedures to configure additional logical libraries.



Note

A re-initialization of the library is necessary if the library properties are changed.

Additional Configuration

The following actions can be performed to make the Scalar DLC more user-friendly.

Create User

By default, the Scalar DLC contains two pre-defined users to work with Management GUI: default administrator (admin) and default customer engineer (atac). More users can be created.

Step 1 Log on the Management GUI as administrator.

Step 2 Using Users Tab (**Configuration > Users tab >> Add new User**) create the new user selecting the user access level and user rights, and specifying login, password, and email settings. Refer to [Create User](#) on page 132 and [Table 21](#) on page 129.

Update ATAC Settings

All problem reports (tickets) created by the customer will be sent by default to ATAC on “watchman@adic.com”. This can be changed if required. Do the following:

- Step 1** Log on the Management GUI as administrator. Check the Scalar DLC email notification settings on **Main Menu > Extended Service > Registration Information** pane. Refer to [Registration Information](#) on page 55. The “Email Notification” field must be checked, and the “SMTP server” and “port” parameters must contain valid information. Contact the local network administrator for details.
- Step 2** Open **Configuration > Users Tab** and select the default CE “atac” (refer to [User](#) on page 131). Change the email settings from “watchman@adic.com” to the required value.
- Step 3** Restart the Scalar DLC service for the changes take effect.

Configure Email Notifications

To notify the customer via email that the given operation has been performed:

- Step 1** Log on the Management GUI as administrator. Create the working configuration. Refer to [Automatic Configuration](#) on page 17 or [Advanced Configuration](#) on page 18.
- Step 2** Using the Rule Wizard (**Main Menu > Wizards > Create Rule**) create the rule that will react when a certain event occurs in the system and will send a notification about this event to a certain email address. Refer to [Create Rule](#) on page 45.



Note

The Scalar DLC database contains the email addresses of all users (refer to [User](#) on page 131) and the email addresses that were entered manually during rule creation (see [Figure 37](#) on page 53 and [Figure 38](#) on page 53). If the required email address is present in this list, it can be selected during the rule creation process; if not, it can be entered manually and will be thereby added to the database.

- Step 3** After creating the rule, go to **Events > Rules Tab** and ensure that the rule is correct and active. Refer to [Rules Tab](#) on page 179.
- Step 4** Check the Scalar DLC email notification settings on **Main Menu > Extended Service > Registration Information** pane. Refer to [Registration Information](#) on page 55. The “Email Notification” field must be checked, and the “SMTP server” and “port” parameters must contain valid information. Contact the local network administrator for the details.
- Step 5** Restart the Scalar DLC service for the changes to take effect.

The received email shall look as follows:

```
Packet Type: <Automatically Open Ticket>
Packet Revision Level: <2.6 build 3>
Current Time: <Friday, Nov 19, 2005 04:07:08 PM>
Scalar DLC s/n: <DLC12345>
Packet Number: <{AFC3A8D1-EE87-4C45-913B-A949907E1D63}.92.3>
Site ID: {}
Source: <Automated: DLC12345>
Total call Time: <N/A>
# of times packet was sent: <0>
=====
```

Site ID: {}
Caller Name: <Automated: DLC12345>
Caller Phone: <none>
Modem Phone: {}
Call-In Enabled: {yes}
Company Name: {Scalar DLC Installation}
Call Type: {not available}
Call Subtype: {not available}
Device: {not available}
System Serial Number: {ADIC Scalar 1000 #111111111}
Item Serial Number: {not available}
Service Action Code: 80
Service Action Code Modifier: <12345678>
Service Action Code Description: <Failures detected in the X-axis Servo system.>
Priority: <not available>
Description: <General hardware problem>
Configuration Table: <not available>
Physical Library Name <ADIC Scalar 1000 #11111>



Note

Some fields may be empty, or contain <none> or <not available> which is correct especially in case of the automatically created/opened tickets with the appropriate email notification.

Installing New Slots

When the new slot (for example, drive) is installed in the physical library, perform the following actions so that the Scalar DLC logical libraries have the correct reflection of the current hardware.

- Step 1** Install the slot(s), make all proper connections according to the library *Operator Guide*.
- Step 2** Execute **Teach** command from the robot Operator Panel. After the command is finished (that may take some time) the slot will appear in appropriate range of the physical library.
- Step 3** For each newly installed slot, verify the partition settings.
 - a. If the new slot has appeared in the unpartitioned space, then everything is correct and it can be used as any other slot after adding to the appropriate partition.
 - b. If the new slot has appeared in the partitioned space and its type and media domain match the existing partition properties, it is accessible for every client that can access the appropriate partition.
 - c. If the new slot has appeared in the partitioned space and its type and media domain do not match the existing partition properties (for example, SDLT 220 Drive appeared in the middle of IBM LTO Drive partition), the newly installed slot becomes *incompatible*, and the Management GUI shows it (see [Table 16](#) on page 67 and [Table 15](#) on page 66). Admin must manually correct the situation by changing the range of the existing partition until it will not cover the new (not compatible) slot. Then another partition must be manually created and assigned to the appropriate logical libraries. Perform a complete **inventory** after all assignments are done.

Operating the Tape Library Doors

It is possible to stand up right before the tape library device and manipulate its doors when the Scalar DLC is in work. Moreover, it is required sometimes.

The Scalar DLC will reflect as much as it could, but some operations (especially executed by the clients who use backup applications and do not monitor the resource before launching the command) are to be failed when the doors are opened.

Front Door

When the front door is in open state, the Scalar DLC resources can be described as follows:

Element	State, single-aisle library	State, dual-aisle library
Robot	Offline	Offline
Physical library	Offline	Online ^a
Partition, drive, storage, mailbox	Offline	Online / offline ^b
Logical library	Offline	Online / offline ^c

a. That is, online if the second front door is closed and the second robot is online.

b. Depends on the state of the robot where the partition is physically located on, whether it is offline or online.

c. Depends on the partitions the library contain, whether all of them are offline or some are online.

When the front door of Robot1 on the dual-aisle system is opened, the Robot2 may still perform operations that do not use resources managed by Robot1 (for example, **mount** from <Robot2 storage> to <Robot2 drive> shall pass). If the customer-requested resource is in Robot1 control, the Scalar DLC marks the resource as 'not accessible' and the operation shall fail.



WARNING

BE VERY CAREFUL WHEN OPENING THE FRONT DOOR. THE AISLE MECHANICS WILL GO OFFLINE WHEN THE DOOR IS OPENED BUT IT TAKES TIME.

After the front door is closed the robot must be manually turned online from the operator panel. Then the robot starts the complete **inventory** operation to check whether the new elements are installed, and if so, map them correctly.

I/E Station Door

When the door of insert/eject station is opened the Scalar DLC marks the elements of this station as 'not accessible'. Any operation that involves the non-accessible resource (for example, **move** to the non-accessible mailbox slot) will fail. The other operations (for example, **dismount**, **clean**, **move** to the mailbox slot of the other insert/eject station) shall pass.

Closing the insert/eject door starts the **partinventory** (partial inventory) of the appropriate insert/eject station to check whether the new cartridges were put in the library or the cartridges ejected to the mailbox were removed.

Managing the Database

The separate Database Tool (refer to [Database Tool](#) on page 206) is used for every operation that is allowed with the Scalar DLC database. The tool is launched from **Start > Programs > ADIC Distributed Library Controller > Scalar DLC DB Tool** (or right-click on Scalar DLC tray icon and then **Tools > Scalar DLC DB Tool**).

Set Up Database Backup Mode

- Step 1** Launch DB tool, log in and open Extended mode tab (refer to [Extended Mode](#) on page 209).
- Step 2** Check *Full recovery mode* box if the database is to be backed-up with full information. Uncheck the box if only the database itself is to be backed-up.
- Step 3** Press **Apply** button to apply settings, them **Exit** to close DB tool.

Schedule Database Backup

- Step 1** Launch DB tool, log in and open Backup tab (refer to [Database Backup](#) on page 207).
- Step 2** Set up the *Backup destination* in automatic backup. Check the *Time-generated file names* box if the backup files are to be named according the backup date.
- Step 3** Set up the *Backup schedule* and then check *Enable schedule* box.
- Step 4** Press **Apply** button to apply settings, them **Exit** to close DB tool.

Schedule Transaction Logs Backup

- Step 1** Launch DB tool, log in and open Extended mode tab (refer to [Extended Mode](#) on page 209).
- Step 2** Set up the *Destination* in automatic transaction logs backup.
- Step 3** Set up the *Schedule* and then check *Enable schedule* box.
- Step 4** Press **Apply** button to apply settings, them **Exit** to close DB tool.

Backup Database Manually

- Step 1** Launch DB tool, log in and open Backup tab (refer to [Database Backup](#) on page 207).
- Step 2** Set up the *Backup destination* in *Manual backup*.
- Step 3** Press **Execute** button to backup the database to a file, them **Exit** to close DB tool.

Schedule Database Compact

- Step 1** Launch DB tool, log in and open Compact tab (refer to [Database Compact](#) on page 212).
- Step 2** Set up the *Compact schedule* and then check *Enable schedule* box.
- Step 3** Press **Apply** button to apply settings, them **Exit** to close DB tool.

Compact Database Manually

- Step 1** Launch DB tool, log in and open Compact tab (refer to [Database Compact](#) on page 212).
- Step 2** Press **Execute** button to compact the database, then **Exit** to close DB tool.

Restore Database from Backup

- Step 1** Launch DB tool, log in and open Restore tab (refer to [Database Restore](#) on page 214).
- Step 2** Stop the Scalar DLC software (*bring offline* for a failover solution).
- Step 3** Select *Database* to restore from a regular backup, then select a backup from a database backup list.
- Step 4** To restore the database with transaction logs, check also *Restore with logs* box and select the transaction log.
- Step 5** Press **Restore** button to restore the database, then **Exit** to close DB tool.
- Step 6** Start/bring online Scalar DLC again.

Restore Database from File

- Step 1** Launch DB tool, log in and open Restore tab (refer to [Database Restore](#) on page 214).
- Step 2** Stop the Scalar DLC software (*bring offline* for a failover solution).
- Step 3** Select *From device* to restore from a file, then select a device name (file) to restore the database from.
- Step 4** Change the names for a database file and transaction log file if the default values are not good enough.
- Step 5** Press **Restore** button to restore the database, then **Exit** to close DB tool.
- Step 6** Start/bring online Scalar DLC again.

Archive Database

- Step 1** Launch DB tool, log in and open Save tab (refer to [Database Save](#) on page 216).
- Step 2** Set up the *Destination*.
- Step 3** Press **Save** button to save the database archive to a file, then **Exit** to close DB tool.

4

Management GUI

This chapter describes the structure of Scalar DLC Management GUI and provides a brief description of its functionality.

The Management GUI screen is divided into three areas (see [Figure 11](#) on page 30).

- The upper portion of the screen contains the Main Menu bar. Refer to [Main Menu Bar](#) on page 30.
- The center portion of the screen contains the library related menus, configuration and service tabs, and more. Refer to [GUI Tabs](#) on page 61.
- The lower portion of the screen holds the GUI Log. Refer to [GUI Log](#) on page 69.

Figure 11 Management GUI

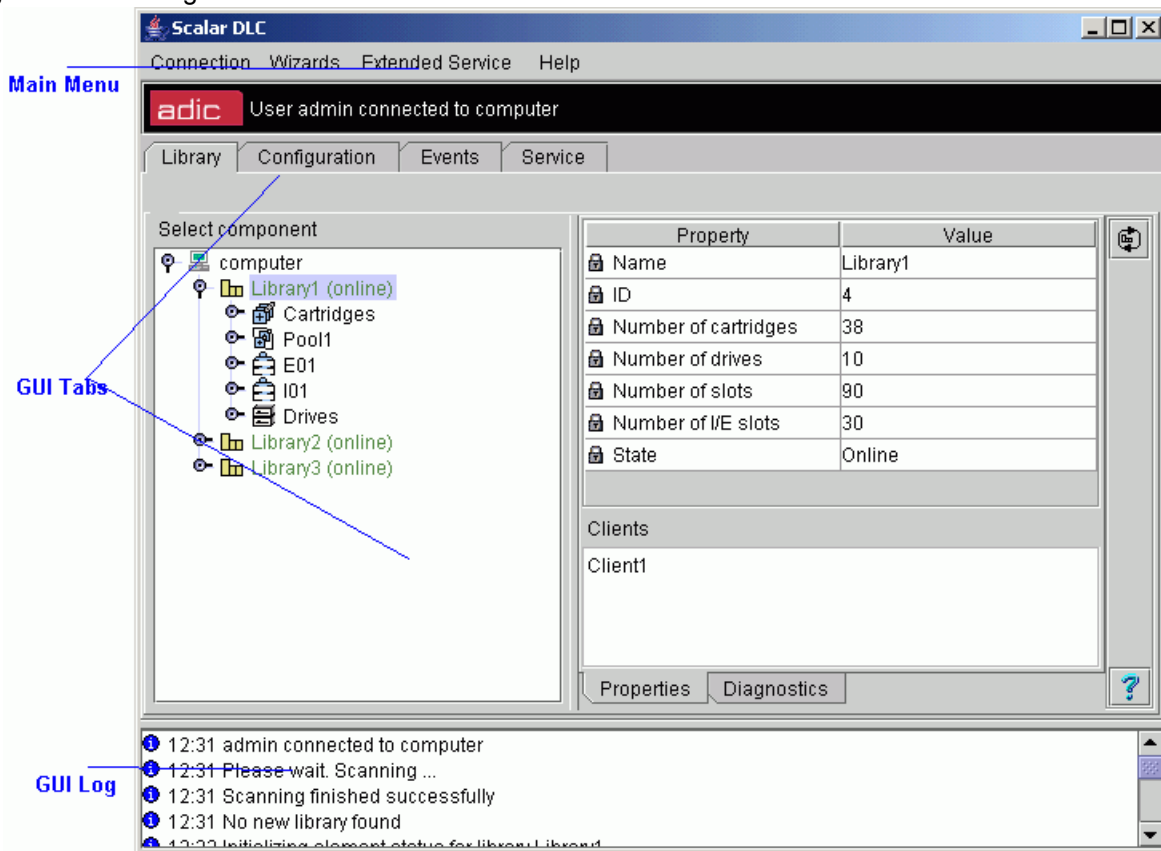

Main Menu Bar

The Main Menu Bar contains five sections. See [Figure 12](#) on page 30. The sections are:

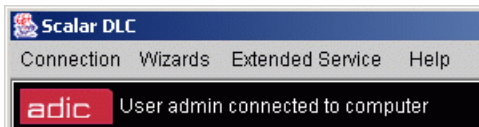

- Screen Refresh Icon. Forces the Management GUI screen to refresh. Refer to [Screen Refresh Icon](#) on page 31.
- Connection. Contains the user connection options. Refer to [Connection](#) on page 31.
- Wizards. Contains the wizard-based engines for configuring logical libraries, assigning partitions, creating tickets, and creating rules. Refer to [Wizards](#) on page 32.
- Extended Service. Contains some service panes like registration information, online log viewer etc. Refer to [Extended Service](#) on page 54.
- Help. Contains Management GUI help panes. Refer to [Help](#) on page 60.

Figure 12 Main Menu Bar



Screen Refresh Icon

The broad black bar containing the red ADIC logo is a screen refresh icon. It also contains the user-to-host connection status (as at the example picture, *User admin connected to computer*, where **admin** is the user name and **computer** is either the Scalar DLC host name or the Scalar DLC cluster name). This button forces the Management GUI screen to refresh.

Icon	Description
	Refresh the Management GUI screen. The black bar itself acts as the refresh button, too.
 Note	Depending on the PC performance and the current Scalar DLC configuration, the refresh may take up to several minutes.
 Note	Some update (for example, library statistic) is not performed by the global refresh but requires special refresh operation initiated by an appropriate button.

Connection

This section contains the basic Log off and Exit operations.

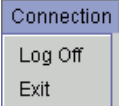
Options	Name	Description
	Log Off	Log off the Management GUI. A new log on dialog appears.
	Exit	Close and exit the current applet or application and log off the user.





Wizards

The *Wizards* section contains the wizard-based engines used to create some Scalar DLC internal elements. It contains the following options:

Options	Wizard	Description	Access
	Create Configuration	Creates the logical library according to the user-specified values (library name, assigned client, etc.). Refer to Create Configuration on page 32.	Admin only
	Assign Partitions	Either assigns a number of partitions to the logical library, or removes a number of partitions from the logical library (without deleting these partitions physically). Refer to Assign Partitions on page 38.	Admin only
	Create Ticket	Creates the report issue (ticket) which will be immediately sent to the ADIC Technical Support Center (ATAC). Refer to Create Ticket on page 40.	All users
	Create Rule	Creates the rule that will notify the specified user or person that a certain event has been occurred. Refer to Create Rule on page 45.	Admin only

All wizards contain the same operational buttons ([Table 7](#)).

Table 7 Wizard Buttons

Name	Icon	Operation	Description
First		Click	Return to the first dialog (disabled at the first wizard dialog).
Previous		Click	Return to the previous dialog (disabled at the first wizard dialog).
Next		Click	Go to the next wizard dialog.
Create/Finish		Click	Create (only at the last dialog).
Cancel/Exit		Click	Cancel creation or exit wizard after successful creation.

Create Configuration

The Configuration wizard: creates a logical library that covers all the parts of the selected physical library; creates two identical mailboxes (I01 and E01) that cover the entire insert/eject area; and assigns a client to the created library. The wizard automatically creates the required partitions in the ranges of a physical library and assigns them to the logical library.

Selecting the *Create Configuration* option activates the Configuration wizard. The first dialog is Physical Library selection. See figure below.

Figure 13 Select Physical Library

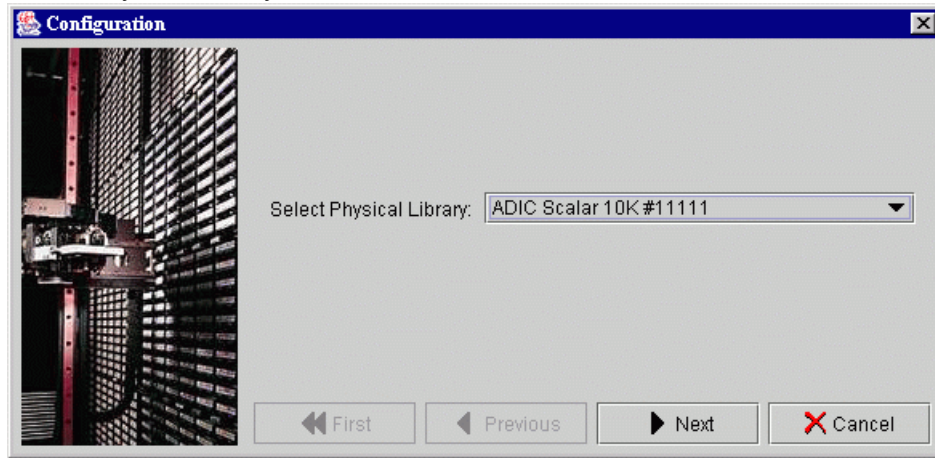

Name	Operation	Description
Select Physical Library	Select	Select the physical library from the combo box. The created library will be based on the selected device.

The next dialog is Logical Library Selection. See figure below.

Figure 14 Select Logical Library

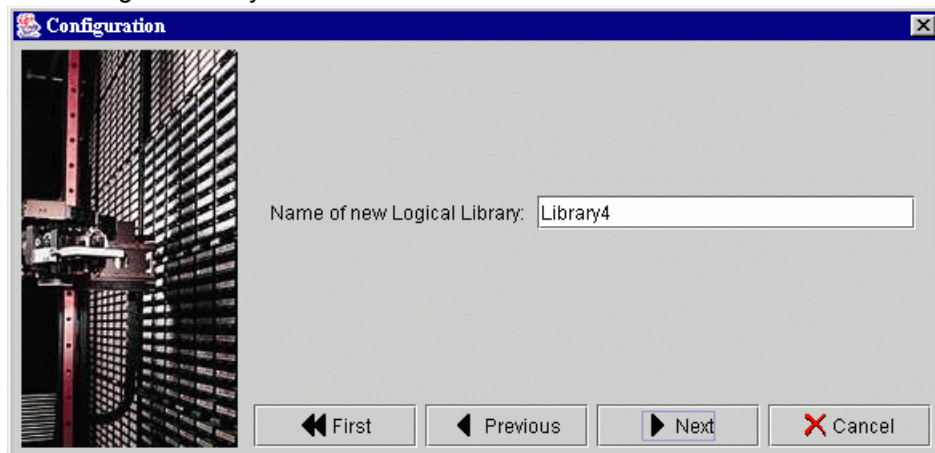

Accept the default name or enter the desired name. ADIC recommends accepting the default name while being sure not to duplicate the name of existing libraries.

Name	Operation	Description
Name of new Logical Library	Enter	Enter the new logical library name.

The next dialog is Configuration Method selection. See figure below.

Figure 15 Select Configuration Method

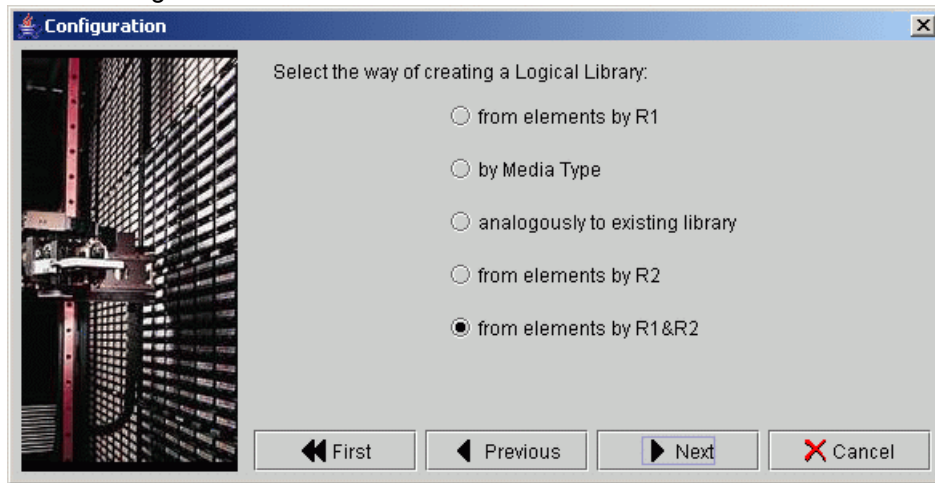

Name	Operation		Description
Define the method of creating a Logical Library	Select	by Media Type	Create the single-media library. The Next button will show the Figure 16 on page 35 with the media selection dialog.
		analogously to existing library	Create the copy of already created library. Enabled only when there is at least one logical library already. The Next button will show the Figure 17 on page 35 with the prototype selection dialog.
		from unused elements	Create the library from the elements that are currently <u>not</u> assigned to any other logical library. Enabled only when there is at least one not assigned element in a physical library.
		from elements by R1	Create the library from the elements available for the Robot1.
		from elements by R2	Create the library from the elements available for the Robot2. Enabled only for the dual-aisle physical library.
		from elements by R1 & R2	Create the library from the elements available for both Robot1 and Robot2. Enabled only for the dual-aisle physical library.

Figure 16 Select Media

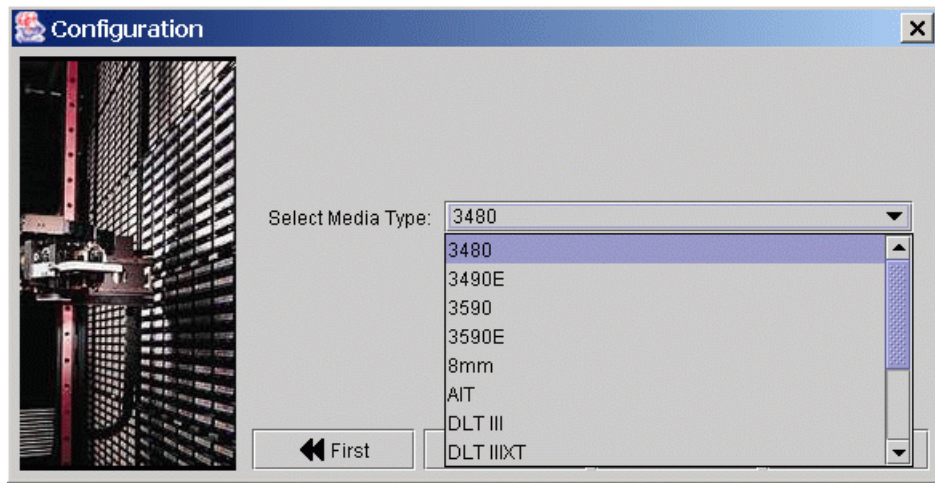

Name	Operation	Description
Detect media type	Select	Select the media type for the single-media library. Refer to Media Types on page 246.

Figure 17 Select Library Prototype

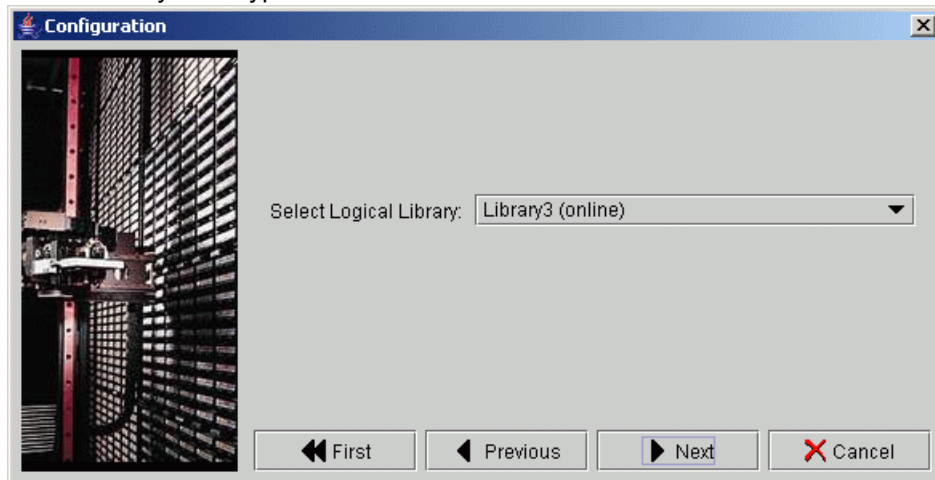

Name	Operation	Description
Select logical library	Select	Select the existing logical library which will be the prototype for the new library.

The next dialog is Mailbox selection.

Figure 18 Select Mailbox

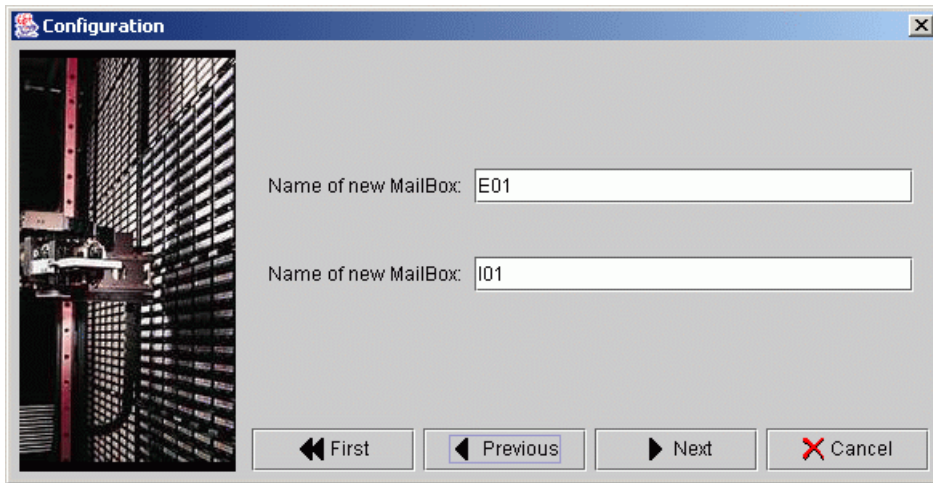

Accept the default names or enter the desired names. ADIC recommends accepting the default names.

Name	Operation	Description
Name of new Maibox	Enter	Enter the name of the new mailbox (E01 for export).
Name of new Maibox	Enter	Enter the name of the new mailbox (I01 for import).

The next dialog is Client selection. See figure below.

Figure 19 Select Client

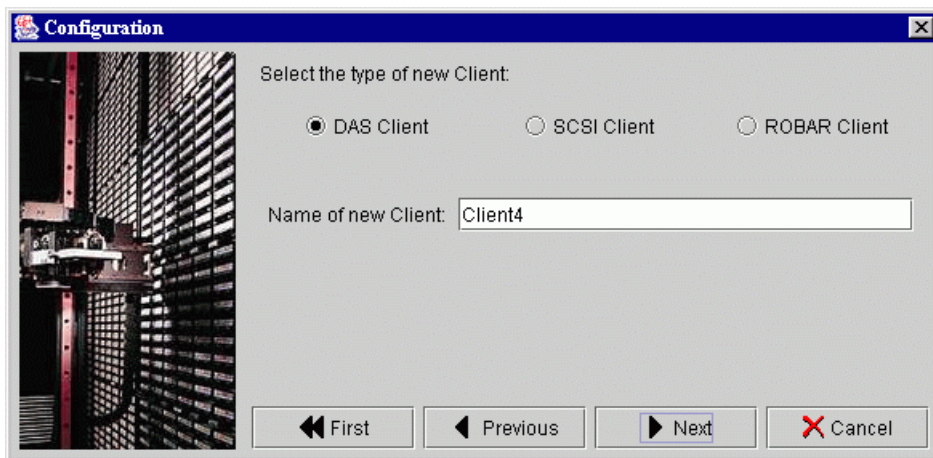

Name	Operation	Description
Select the type of new Client	Select	<p><i>DAS Client</i> creates the DAS client with all parameters by default. Always available if the DAS Client support is installed.</p> <p><i>SCSI Client</i> creates the SCSI Client assigned to the first free LUN of the first existing Target. Available only after the SCSI is configured (at least one target is created and at least one LUN is free). Refer to Create Target on page 169 and Create LUN on page 170.</p> <p><i>ROBAR Client</i> selects the ROBAR Client. Available only after the ROBAR interface is configured (non-zero port is specified). Refer to ROBAR on page 156.</p>
Name of new Client	Enter	Enter the name of the new client.

Accept the default name or enter the desired name. ADIC recommends accepting the default name while being sure not to duplicate an existing client name.

The next dialog is Configuration Summary. See figure below.

Figure 20 Configuration Summary

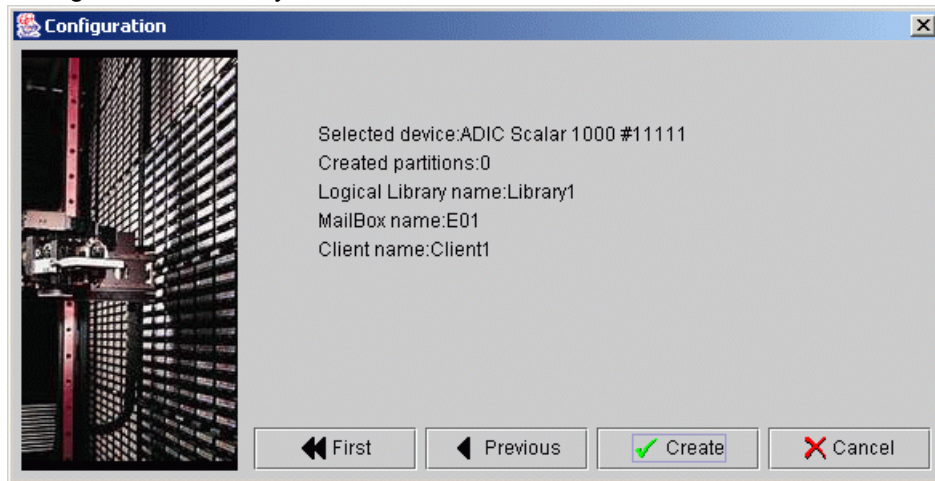

Name	Operation	Description
Summary	Supplied	Be sure that the data entered from the previous dialogs is correct.

The final configuration dialog then appears.

Figure 21 Configuration Complete

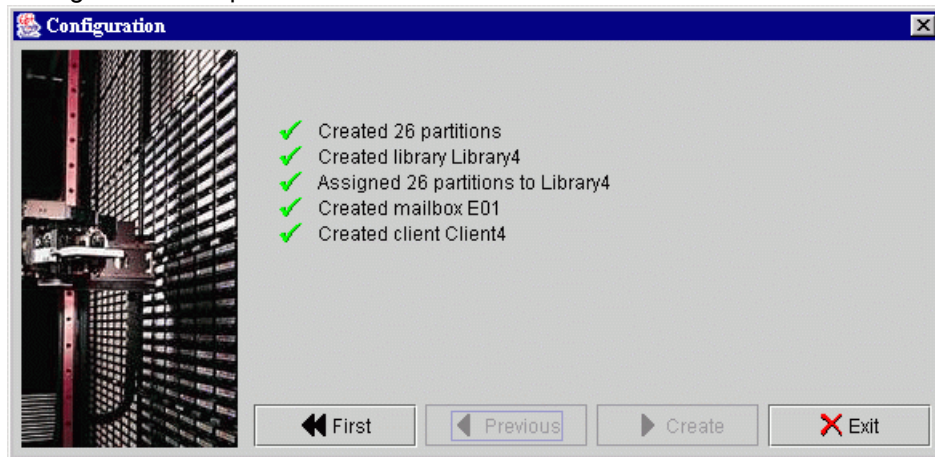

Name	Operation	Description
Operation list	Supplied	The list of operations executed by configuration wizard.

Assign Partitions

The Partition Assignment wizard assigns the partition(s) to the logical library or executes the backward operation. The logical library and the partitions to assign must be created before launching the wizard.

Selecting the *Assign Partitions* option activates the Partition Assignment wizard.

There are two types of Partition Assignment wizard first screens. Figure below appears when the selected logical library contains at least one partition.

Figure 22 Partitions Contained

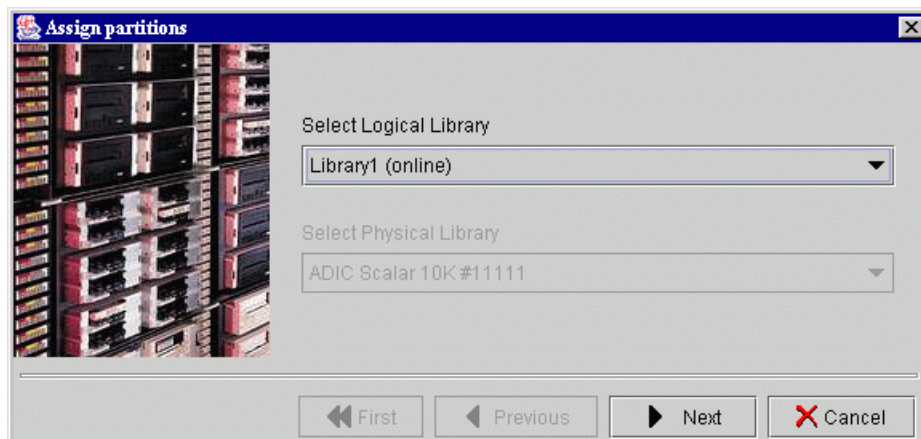
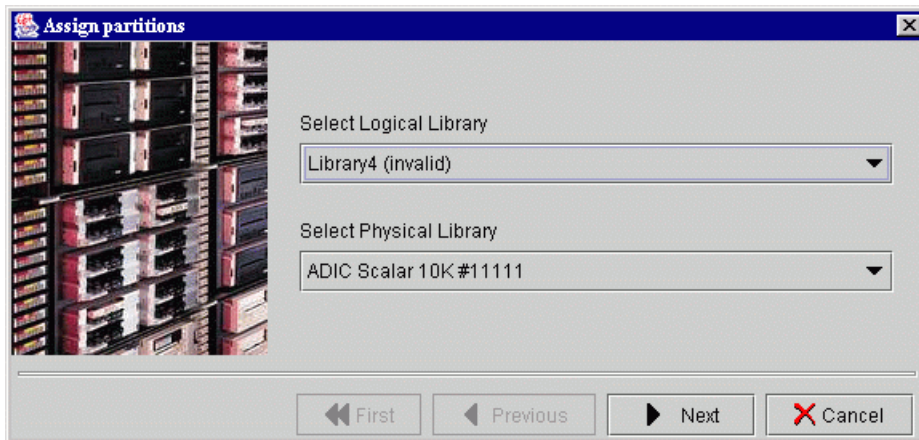

Figure below appears when the selected logical library contains no partitions.

Figure 23 Partitions Not Contained



Name	Operation	Description
Select Logical Library	Select	The logical library to assign/unassign partition(s).
Select Physical Library	Supplied	The physical library whose partition(s) are already assigned to the selected logical library.
	Select	The physical library whose partition(s) should be assigned to the selected logical library.

The next wizard screen shows the assign/unassign dialog.

Figure 24 Partition List

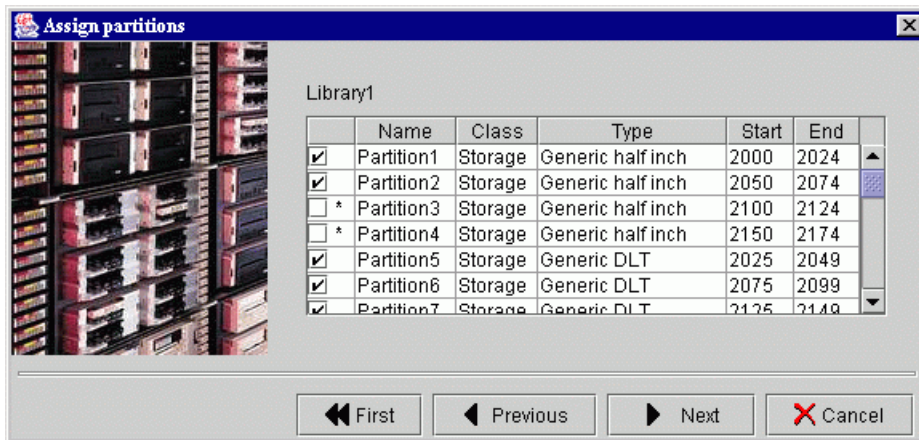

Name	Operation	Description
Library name	Supplied	The logical library to assign/unassign partition(s).
Partition(s)	Check	The checked partitions are, or should be, assigned to the logical library. The not checked partitions currently are not assigned to the library or should be unassigned from it. The changes are marked with asterisks.

Name	Operation		Description
Partition properties	Supplied	Name	Partition name.
		Class	Partition class (Storage, I/E, Drive). See Table 13 on page 65.
		Type	Partition media type. Refer to Storage Types on page 247, Mailbox Types on page 248, or Drive Types on page 249.
		Start	Starting address in the range of the partition elements.
		End	Ending address in the range of the partition elements.

Figure 25 Partitions Summary

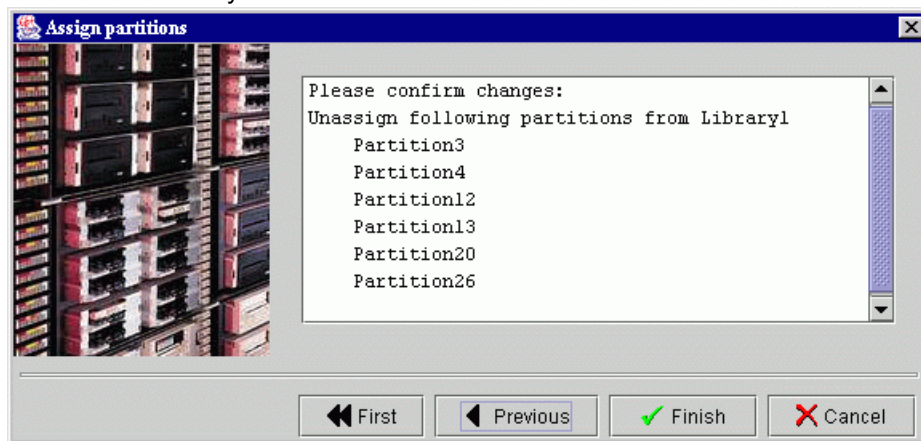

Name	Operation	Description
Summary	Supplied	Shows the summary for the assign/unassign partition(s)

Create Ticket

Ticket is a brief report of the problem encountered by the user that should be solved by ADIC Technical Assistance Center (ATAC). After the ticket that describes the problem is created, the email notification is sent to ATAC. The ATAC solution will allow the CE (customer engineer) to begin working toward a solution of the problem. Information supplied to the ticket becomes a part of the ATAC Calls pane. Refer to [ATAC Calls Tab](#) on page 189.

Selecting the *Create Ticket* option activates the Ticket wizard.

Figure 26 Ticket Registration

The screenshot shows a window titled "Create Ticket" with a sidebar image of a server rack. The main area contains three input fields: "Enter your name:" with the value "My_Name", "Enter your phone number:" with the value "My_Phone", and "System Serial Number:" with the value "DLC66666". At the bottom, there are four buttons: "First", "Previous", "Next", and "Cancel".

Name	Operation	Description
Enter your name	Enter	The issue originator name.
Enter your phone number	Enter	The issue originator contact phone number.
System Serial Number	Supplied	The system serial number (taken directly from the Scalar DLC Database).

The Ticket Priority and Description dialog is the next step in the wizard process. A priority is selected, and a description of the problem is entered.

Figure 27 Ticket Priority and Description

The screenshot shows the same "Create Ticket" window. The "Select a priority for the ticket:" dropdown menu is set to "Critical". Below it is a text area labeled "Enter a brief description of the problem:" containing the text "brief description". The navigation buttons at the bottom remain the same.

Name	Operation	Description
Select a priority for the ticket	Select	<p><i>Critical</i> means the problem must be solved immediately. Highest priority.</p> <p><i>Urgent</i> means that solving the problem is very important but not critical. High priority.</p> <p><i>Major</i> means that the problem should be solved. Medium priority.</p> <p><i>Minor</i> means that the problem should be solved. Low priority.</p> <p><i>Enhancement</i> means that the problem should be solved. Lowest priority</p>
Enter a brief description of the problem	Enter	A description of the problem.

The Ticket Category dialog is used to select a category for the problem. The frequency of the problem is established.

Figure 28 Ticket Category

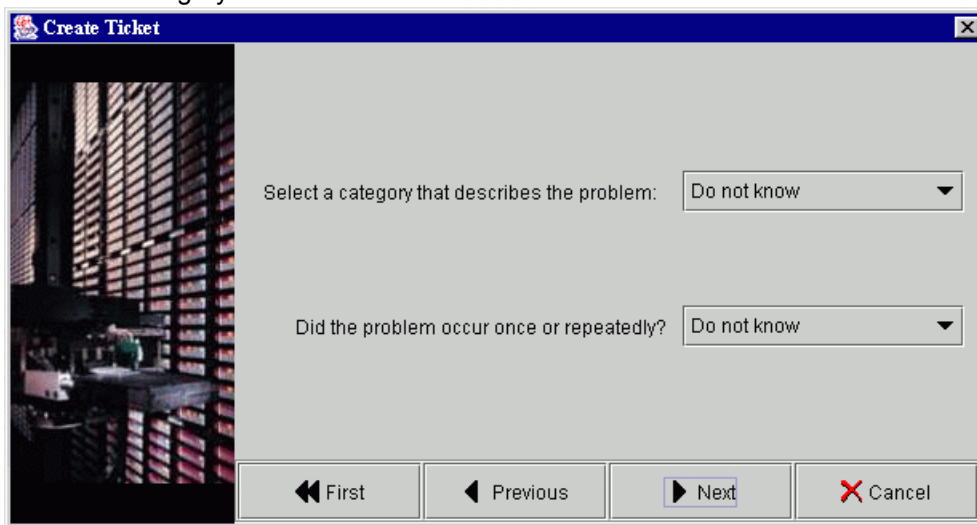

Name	Operation	Description
Select a problem category that describes the problem	Select	<p><i>Do not know</i> means the problem category is unknown.</p> <p><i>Operator</i> means the problem source is an operator error.</p> <p><i>Hardware</i> means the problem source is a hardware error.</p> <p><i>Firmware</i> means the problem source is a software error.</p> <p><i>Service call</i> means the user has asked for service help.</p> <p><i>Configuration</i> means the problem source is a wrong system configuration.</p> <p><i>Statistical</i> means the problem source is statistical data.</p>

Name	Operation	Description
Did the problem occur once or repeatedly?	Select	<p><i>Do not know</i> means the problem frequency is unknown.</p> <p><i>Temporary</i> means the problem occurred once and was not reproduced.</p> <p><i>Permanent</i> means the problem appeared several times.</p>

The Ticket Device, Library, and Client dialog selects the problematic device, details the location of the logical library that contains the device, and identifies the associated client.

Figure 29 Ticket Device, Library, and Client

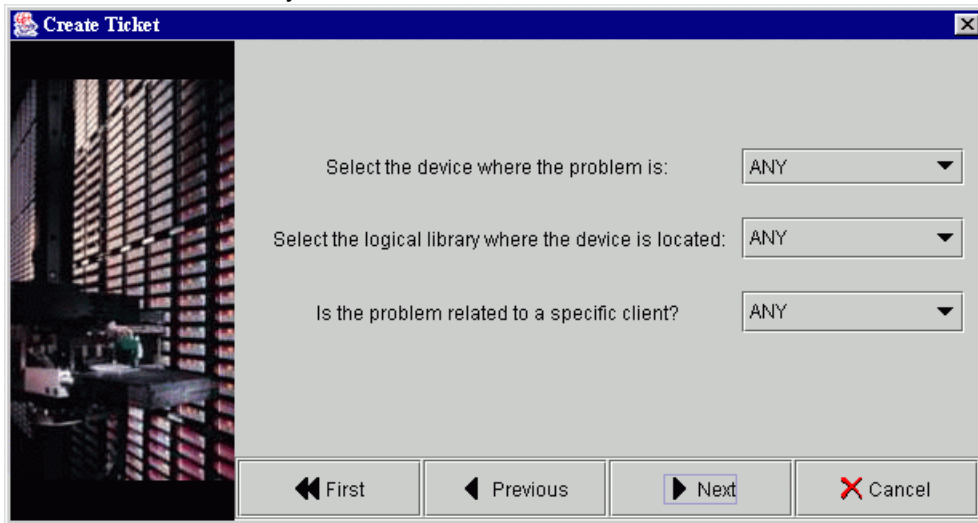

Name	Operation	Description
Select the device where the problem is	Select	Select the device from the combo box if the problem is somewhere in the device.
Select the logical library where the device is located	Select	Select the logical library from the combo box if the problem is with the logical library.
Is the problem related to a specific client	Select	Select the client from the combo box if the problem related with a client.

The Ticket Service Code dialog establishes the service code associated with the problem.

Figure 30 Ticket Service Code

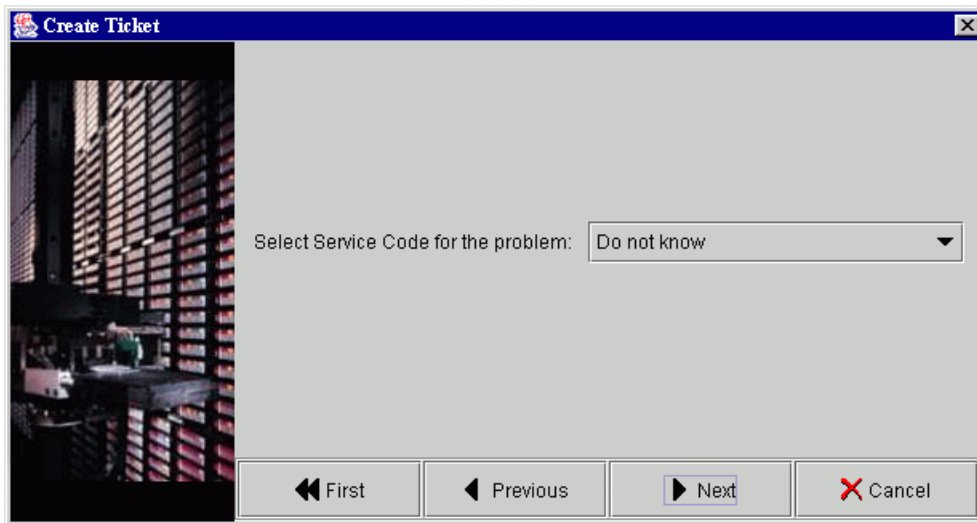

Name	Operation	Description
Select the Service Code for the problem	Select	<p><i>Do not know</i> means the code is unknown.</p> <p><i>Unscheduled Repair</i> means an unexpected repair is required.</p> <p><i>Scheduled Repair</i> means a pre-arranged time has been allocated for the repair.</p> <p><i>Information Call</i> means information is sent to ATAC.</p> <p><i>Customer Resp.</i> means the problem is caused or belongs to the customer.</p> <p><i>Preventive Maint.</i> means routine preventive maintenance is scheduled.</p> <p><i>Installation</i> means the ticket is generated to notify ATAC about the installation of the system.</p> <p><i>De-Installation</i> means the ticket is generated to notify ATAC about a system de-installation.</p> <p><i>EC/Field Bill</i> means a service call is the result of an EC/Field build installation.</p> <p><i>Feature Code Change</i> means a new feature or function is added to the system.</p>

The Ticket Summary dialog contains selected information from the previous dialogs. The wizard assembles the data and requires a verification.

Figure 31 Ticket Summary

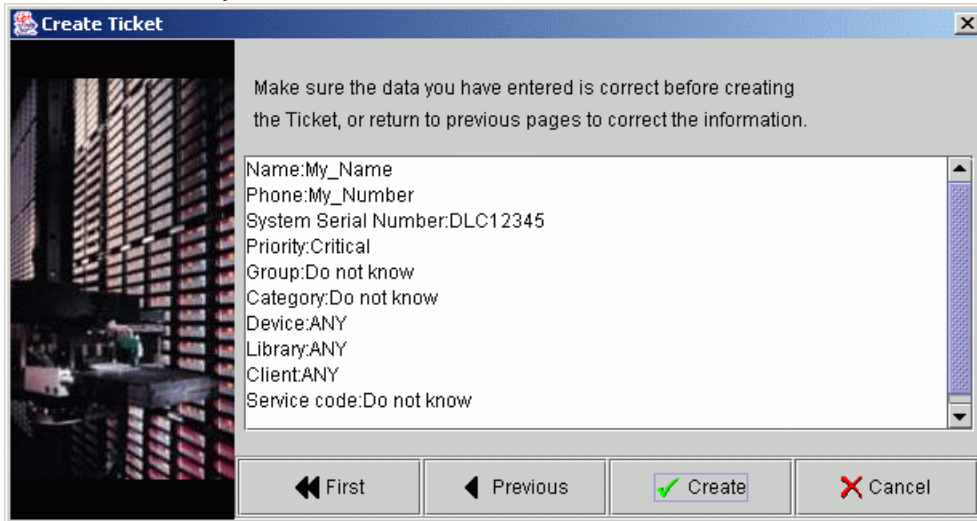

Name	Operation	Description
Summary	Supplied	Be sure that the data entered from the previous dialogs is correct.

 **Note** The **Create** button is disabled while the ticket is in the creation process. During this period, the data is being integrated into the ATAC Calls pane.

Create Rule

The Scalar DLC software contains rules for monitoring system events either by sending notification via email or directly to the Management GUI. In addition, system rules are generated by the Scalar DLC software itself. The user can define rules that will operate in a similar manner. See [Table 8](#) for the detailed description of the events and matching rules configuration.

 **Note** In the table that follows, (Any) means selection “Any,” (None) means selection “None”, (#) means exact selection (for example, **Library1**, or **Client2**).
For the details on Error code, if any, refer to [Error Codes](#) on page 251.

Table 8 Event Specification

Event	Event Group	Specific Event	Error code	Physical Library	Logical Library	Client
Start supervisor	Statistical	SDLC supervisor has been started	0	None	None	None
Stop supervisor	Statistical	SDLC supervisor has been stopped	0	None	None	None

Table 8 Event Specification (Continued)

Event	Event Group	Specific Event	Error code	Physical Library	Logical Library	Client
License expiration warning	Statistical	License is to expire in a few days	0	None	None	None
Physical library is created	Statistical	New physical library is created	0	None	None	None
Physical library is deleted	Statistical	Physical library has been deleted	0	None	None	None
Physical library state changed	Statistical	The library state has changed	0	Any	None	Any
				#		
Logical library state changed	Statistical	The library state has changed	0	None	#	None
Library Tape Alert	Statistical	Message about Drive Tape Alert Flag	0	Any	None	Any
				#		
Drive Tape Alert	Statistical	Message about Drive Tape Alert Flag	0	#	None	Any
Front door closed	Statistical	Library door closed. Context defined below.	0	#	None	Any
Inventory (GUI)	Statistical	Library elements have been inventoried	0	None	#	None
Inventory (auto)	Statistical	Library elements have been inventoried	0	#	None	Any
Inventory (common)	Statistical	Library elements have been inventoried	0	#	#	Any
Move cartridge (common)	Statistical	A cartridge has been successfully moved	0	None	#	#
Move cartridge (client)	Statistical	A cartridge has been successfully moved	0	None	#	Any
						#
Move cartridge (GUI)	Statistical	A cartridge has been successfully moved	0	None	#	Any
Physical element state changed	Statistical	Library elements changed its state	0	#	#	Any

Table 8 Event Specification (Continued)

Event	Event Group	Specific Event	Error code	Physical Library	Logical Library	Client
Logical element state changed	Statistical	Library elements changed its state	0	None	#	None
New firmware loaded	Statistical	New firmware has been loaded to physical library	0	#	None	Any
New firmware loaded	Statistical	New firmware has been loaded to physical library	0	None	#	Any
Drive cleaning	Statistical	Message from Clean Manager about drive cleaning	0	None	#	#
Clean pool requires service	Statistical	A clean's pool condition has become critical	0	None	#	None
Element(s) allocated by client	Statistical	Logical library element has changed its allocation state	0	None	#	#
Cluster node changed	Statistical	Cluster node has been changed	0	None	None	Any
Hardware error: generic, and so forth	Hardware	An erroneous situation has been encountered	217	Any	Any	Any
				#		
Hardware error: accessor cannot pick a cartridge	Hardware	An erroneous situation has been encountered	216	Any	Any	Any
				#		
Hardware error: accessor cannot put a cartridge	Hardware	An erroneous situation has been encountered	215	Any	Any	Any
				#		
Hardware error: destination full	Hardware	An erroneous situation has been encountered	223	Any	Any	Any
				#		
Hardware error: source empty	Hardware	An erroneous situation has been encountered	222	Any	Any	Any
				#		

Table 8 Event Specification (Continued)

Event	Event Group	Specific Event	Error code	Physical Library	Logical Library	Client
Hardware error: accessor cannot move	Hardware	An erroneous situation has been encountered	360	Any	Any	Any
				#		
Hardware error: common	Hardware	An erroneous situation has been encountered	220	Any	Any	Any
				#		
General failure: common	General	An erroneous situation has been encountered	217	Any	Any	Any
					#	#
Not ready: common	General	An erroneous situation has been encountered	205	Any	Any	Any
				#		
Not ready: device is becoming ready	General	An erroneous situation has been encountered	248	Any	Any	Any
				#		
Illegal request: destination full	General	An erroneous situation has been encountered	223	Any	Any	Any
					#	#
Illegal request: source empty	General	An erroneous situation has been encountered	222	Any	Any	Any
					#	#
Illegal request: destination is accessor	General	An erroneous situation has been encountered	358	Any	Any	Any
					#	#
Illegal request: invalid CDB field	General	An erroneous situation has been encountered	363	Any	Any	Any
					#	#
Illegal request: I/E station door open	General	An erroneous situation has been encountered	368	Any	Any	Any
					#	#
Abort: command aborted	General	An erroneous situation has been encountered	376	Any	Any	Any
						#
General failure (Scalar 1000)	General	An erroneous situation has been encountered	247	Any	Any	Any
						#

Table 8 Event Specification (Continued)

Event	Event Group	Specific Event	Error code	Physical Library	Logical Library	Client
General failure (Scalar 1000)	General	An erroneous situation has been encountered	212	Any	Any	Any
					#	#
General failure (Scalar 1000)	General	An erroneous situation has been encountered	354	Any	Any	Any
					#	#
General failure (Scalar 1000)	General	An erroneous situation has been encountered	221	Any	Any	Any
					#	#
General failure (Scalar 1000)	General	An erroneous situation has been encountered	355	Any	Any	Any
					#	#
General failure (Scalar 1000)	General	An erroneous situation has been encountered	226	Any	Any	Any
					#	#
Internal error	Internal	An erroneous situation has been encountered	0	Any	Any	Any
License expired	Configuration	License has been expired	0	None	None	#
Configuration changed	Configuration	Configuration changed	0	None	None	#
Manually created ticket	Ticket	Open ticket (manually)	0	None	None	Any
Automatic created ticket	Ticket	Open ticket (auto)	0	None	None	Any
Ticket in work	Ticket	Continue ticket	0	None	None	Any
Close ticket	Ticket	Close ticket	0	None	None	Any

**Note**

An incorrect rule cannot be created. Only the selections matching the selected event group, event, and so forth, are enabled in the Rule wizard.

Selecting the *Create Rule* option opens the Rule Name dialog. Specify the rule name here.

Figure 32 Rule Name

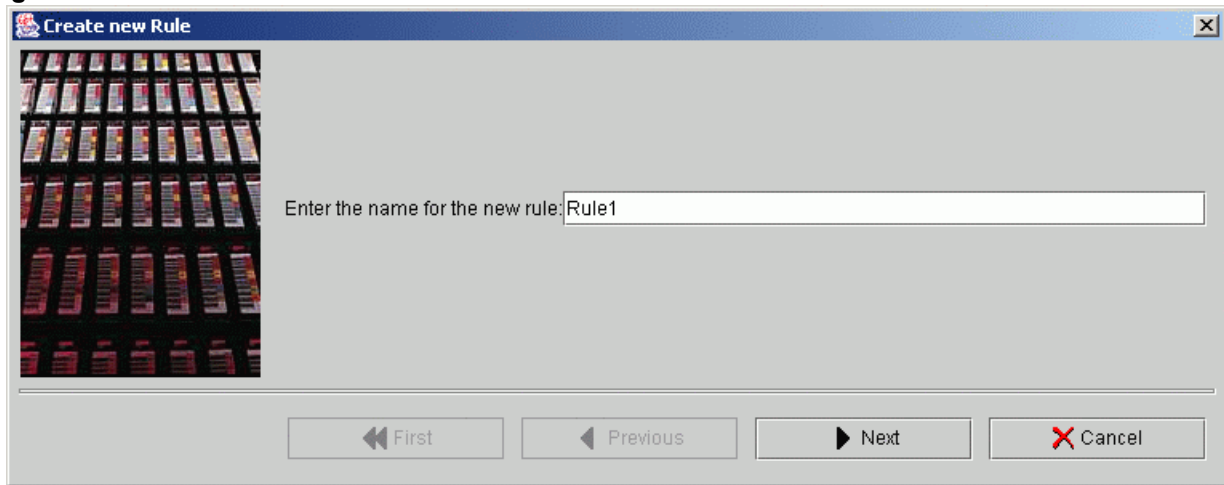

Entry	Operation	Description
Enter the name for the new rule	Enter	The rule name. ADIC recommends using names describing the meaning of the rule.

The Rule Event dialog continues the wizard process. The event group and specific event are specified here.

Figure 33 Rule Event

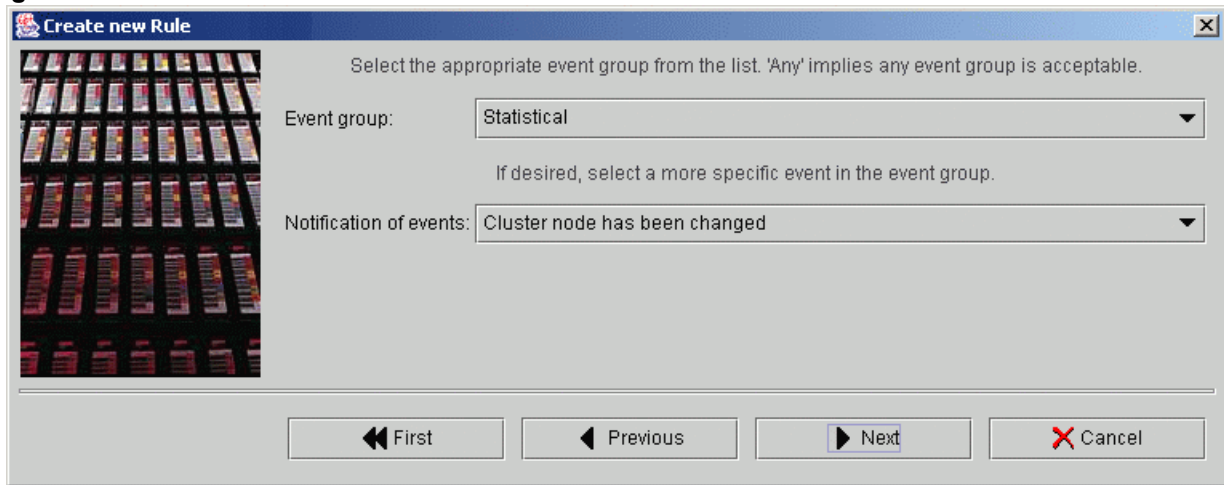

Entry	Operation	Description
Event group	Select	Event group selection. See Table 8 on page 45.
Notification of events	Select	Event selection. See Table 8 on page 45

The Rule Event dialog continues the wizard process. The device, library, and client must be specified here.

Figure 34 Rule Event Location

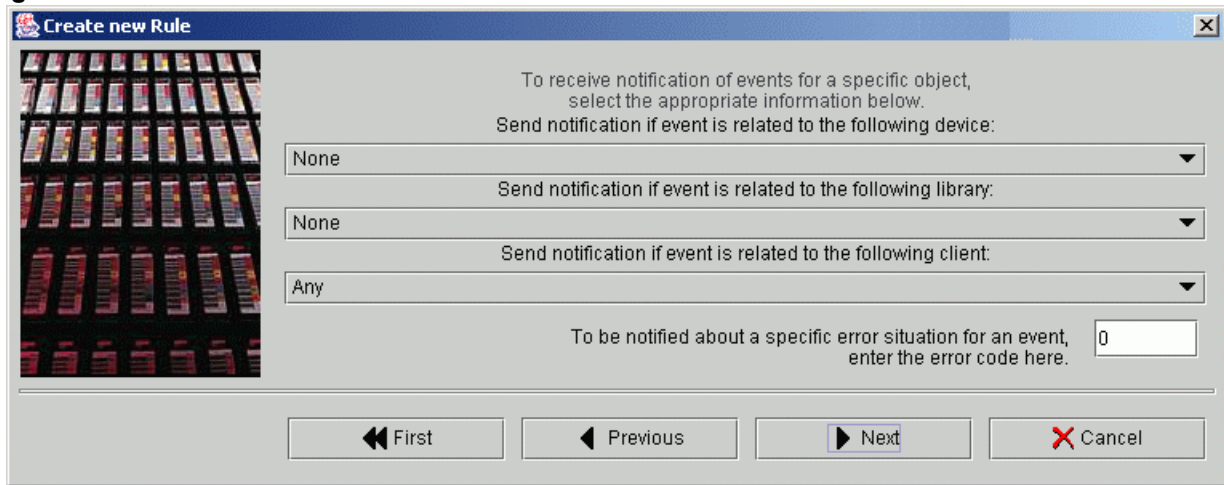

Entry	Operation	Description
Device	Select	Device (Physical library) selection. See Table 8 on page 45.
Library	Select	Logical library selection. See Table 8 on page 45.
Client	Select	Client selection. See Table 8 on page 45.
Specific error situation	Enter	An error code listing. Refer to Error Codes on page 251 and Table 8 on page 45.

The Rule Notification Sent dialog continues the wizard process. The way to send notification is specified here.

Figure 35 Rule Notification Sent Dialog

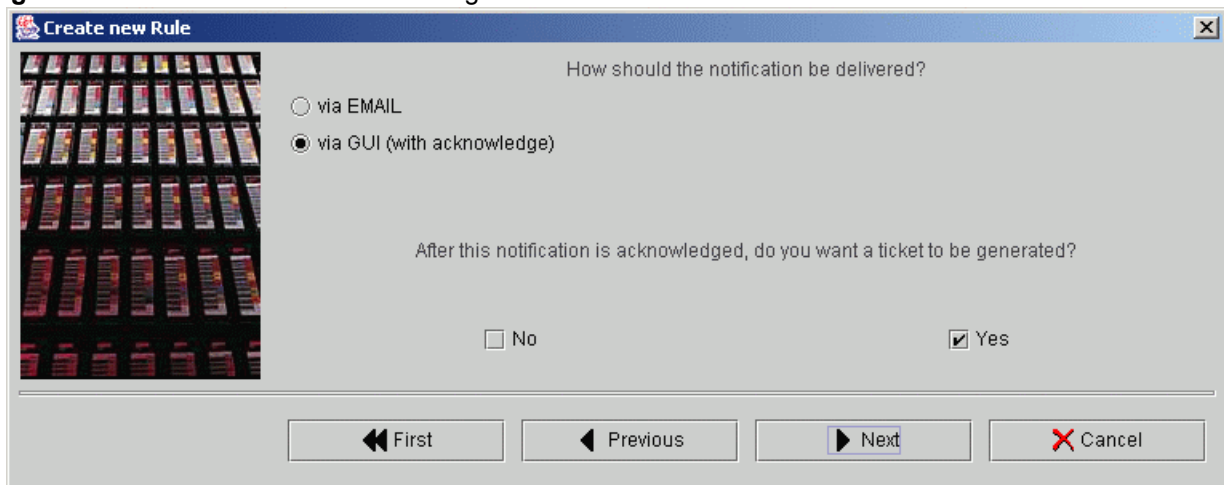

 **Note** Although there exist some predefined rules that send notification via SNMP, the user-created rules other than predefined cannot deliver SNMP notification because of interface properties.

Entry	Operation	Description
Deliver notification by	Select	<i>EMAIL</i> sends notification via email. <i>GUI</i> sends a notification to the Management GUI.
Generate ticket by acknowledge	Check	Enable/disable a service ticket generation request (enable only when <i>GUI</i> selected).
Next	Click	If <i>EMAIL</i> is selected, the <i>Rule Email Destination</i> dialog appears. See Figure 37 on page 53. If <i>GUI</i> is selected, the <i>Rule Notification Receiver</i> dialog appears. See Figure 36 .

The Notification Receiver dialog pane identifies the user who receives the notification.

Figure 36 Rule Notification Receiver

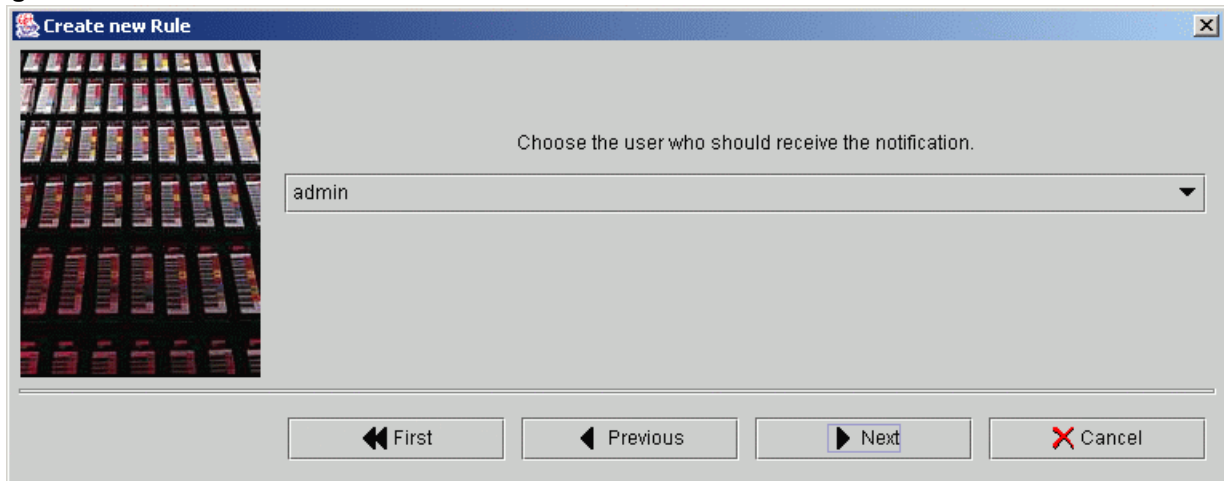

Entry	Operation	Description
Notification receiver	Select	A selection from the user list.
Next	Click	Go to the next wizard dialog (Summary).

The Rule Email Destination dialog identifies the user who receives the notification via email.

Figure 37 Rule Email Destination

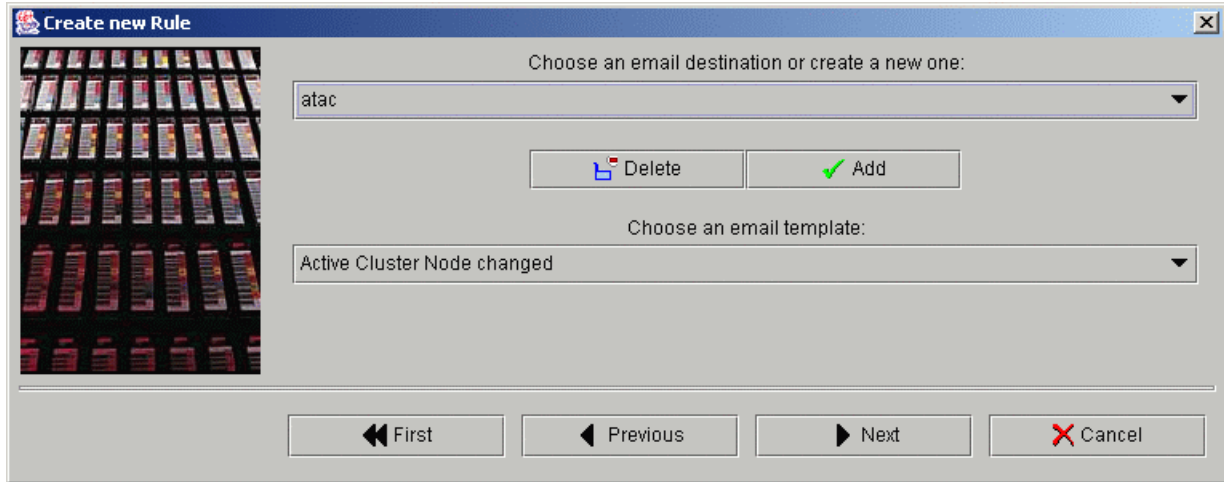

Entry	Operation	Description
Choose/ create destination	Select	A selection from the current list of email destinations. The default entries in the list that cannot be removed are atac (default CE) and the “contact person,” as shown in Figure 40 on page 55.
Delete	Click	Delete the entry from the list.
Add	Click	Add an entry to the list. See Figure 38 .
Choose template	Select	Choose a selection from the combo box. Only valid template (matched the rule) could be selected.
Next	Click	Go to the next wizard dialog (Summary).

The Rule Email dialog identifies the user who should receive the notification.

Figure 38 Rule Email

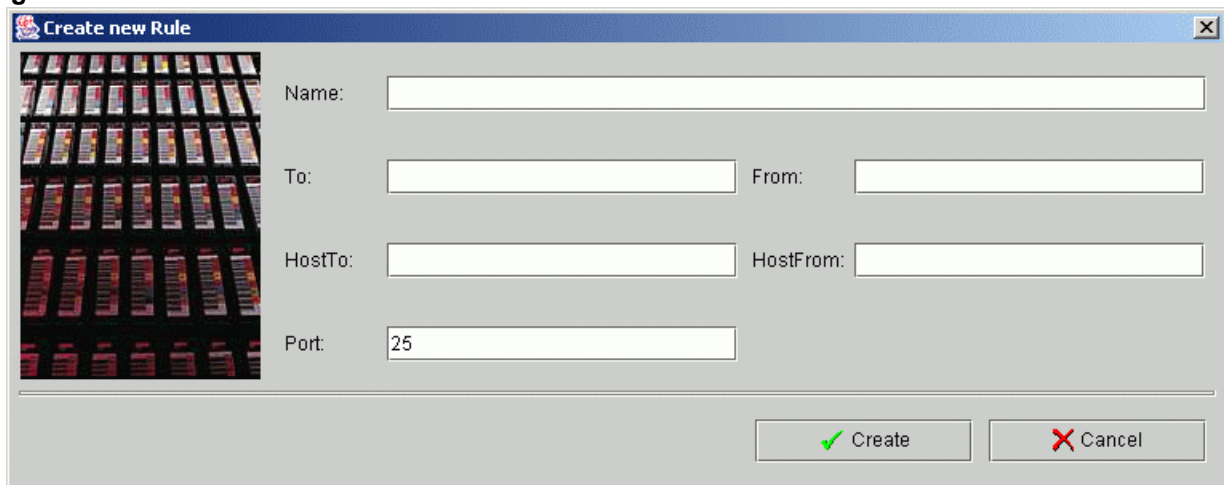

Entry	Operation	Description
Name	Enter	Email sender name.
To	Enter	Email recipient address.
From	Enter	Email sender address.
Host To	Enter	Recipient email server.
Host From	Enter	Sender email server.
Port	Enter	Sender email port (the default is shown).

The last Rule wizard dialog displays the Rule Summary.

Figure 39 Rule Summary

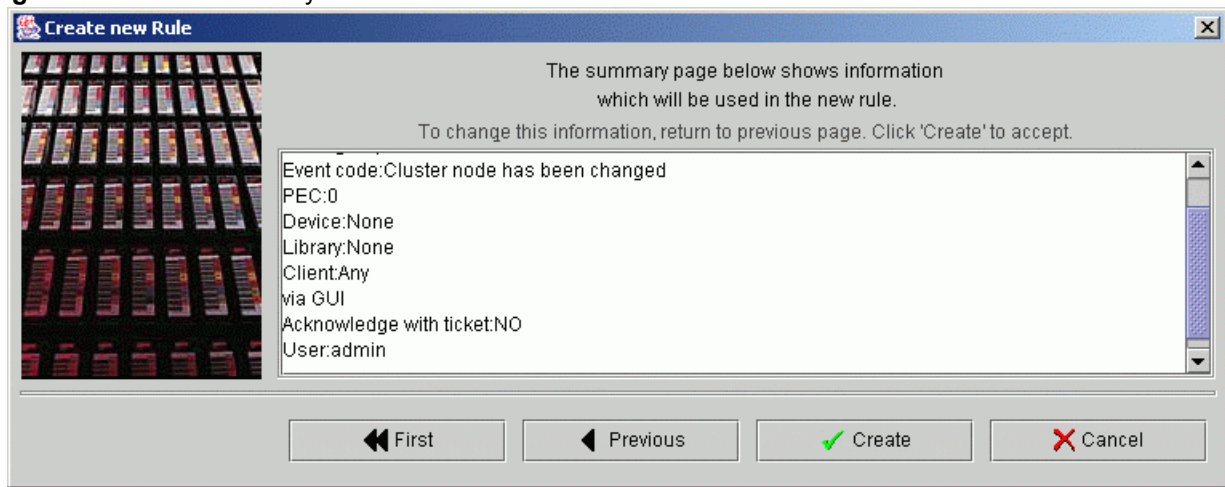

Entry	Operation	Description
Summary	Supplied	Be sure that the data entered from the previous dialogs is correct.

Extended Service

This section contains the extended service operations.

Operations	Name	Description
Extended Service	Registration Information	Scalar DLC registration information. Refer to Registration Information on page 55.
Registration Information	Connect to RMU	RMU connection window. Refer to Connect to RMU on page 56.
Connect to RMU	View Log	Online log viewer window. Refer to View Log on page 57.
View Log		

Registration Information

Selecting the *Registration Information* opens the Registration Information pane. It shows the customer's personal information that was entered during installation of the Scalar DLC software.

Figure 40 Registration Information

Review the registration information and change it if necessary.

Name	Operation	Description
Company name	Enter	The company name.
Company address	Enter	The company mailing address.
Contact name	Enter	The contact person name.
Contact email	Enter	The contact email address.
Email Notification	Check	Check this box to receive notifications via email.
SMTP Server	Enter	The SMTP server name.
Port	Enter	The SMTP server port number.
Contact telephone	Enter	The contact phone number.
Fax	Enter	The contact fax number.
Service contract	Check	Marks the service contract feature as "signed."
Site ID	Enter	The site ID (for the signed service contract).
SDLC serial number	Supplied	The Scalar DLC serial number.
SDLC location	Enter	The Scalar DLC location.
SDLC dial-in number	Enter	The Scalar DLC dial-in number.
ATAC contact	Select	The Scalar DLC ATAC contact region (North America or Europe).

Name	Operation	Description
Reset	Click	Clear all the fields and restore the registration information from the Scalar DLC database
Update	Click	Update the Scalar DLC database with the registration information entered in this pane.
Cancel	Click	Close the pane without saving changes.



CAUTION

If the Email Notification field is not checked, the Scalar DLC will never send notifications via email.

Connect to RMU

Selecting the *Connect to RMU* opens the Remote Management Unit (RMU) connection pane (Figure 41). It allows to connect to the remote management unit.

Figure 41 Connect to RMU

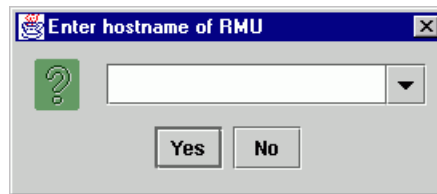

Note

The down arrow will open a list of previously connected RMUs.

The factory installed RMU in each system uses a standard Web browser for remote library access. The supported browsers are:

- Microsoft Internet Explorer version 4.0 and above
- Netscape Navigator version 4.01 and above.

You can do the following by means of the RMU:

- Update RMU firmware
- Access the library status
- Make configuration changes
- Access the library Operator Panel
- Update the library controller firmware
- Retrieve library command and error logs
- Use the ADIC website to access Scalar documentation

The RMU supports Simple Network Management Protocol (SNMP) version 2.0 and acts as an SNMP server. The RMU acquires Tape Alert 3.0 compatibility information from the library over the serial interface port and sends that information to a SNMP server. The RMU also detects a power loss and generates a SNMP trap for notification.

View Log

Figure 42 View Log: standard mode

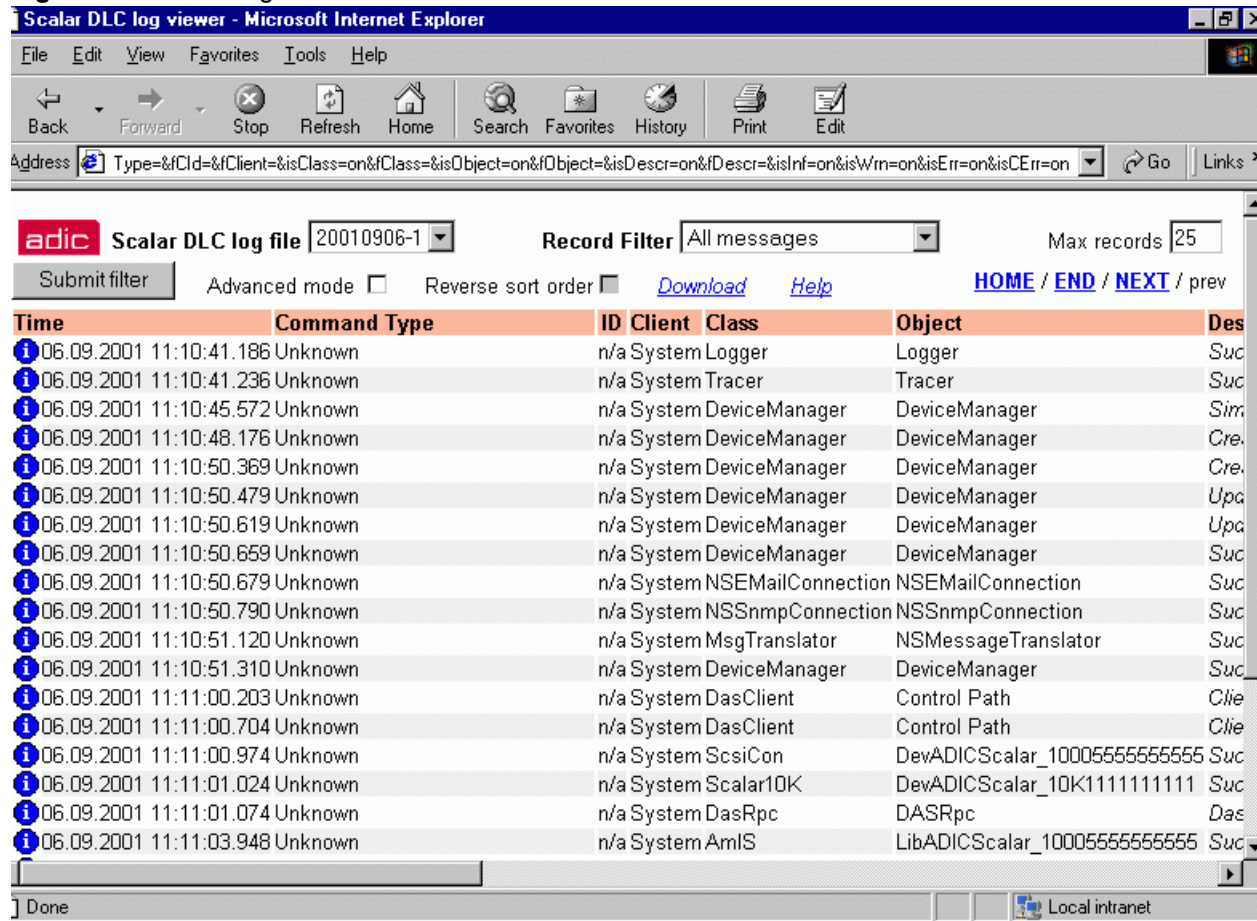

Selecting the View Log opens the online log viewer window. Refer also to the [Log Viewer Utility](#) on page 221.

Name	Operation	Description
Scalar DLC log file	Select	The log file to view can be selected (current session by default).
Record Filter	Select	The filter of records can be specified.
Max records	Enter	The maximum number of records to show can be specified.
Advanced mode	Check	Pressing the Submit filter button shows the View Log advanced mode window. See Figure 43 on page 58.
Reversed sort order	Check	Not supported in current version.
Download	Click	Downloads the current log file.
Help	Click	Open Log help screen.
Home	Click	Go to the first record page.
End	Click	Go to the last record page.
Next	Click	Go to the next record page.

Name	Operation	Description
Prev	Click	Go to the previous record page.
Submit filter	Click	Refresh the current screen to apply changes.
Record messages	Double-click	Open the log message detail window. See Figure 44 on page 59.

Double-clicking on the record message opens the log message detail window. See [Figure 44](#) on page 59.

Figure 43 View Log: advanced mode

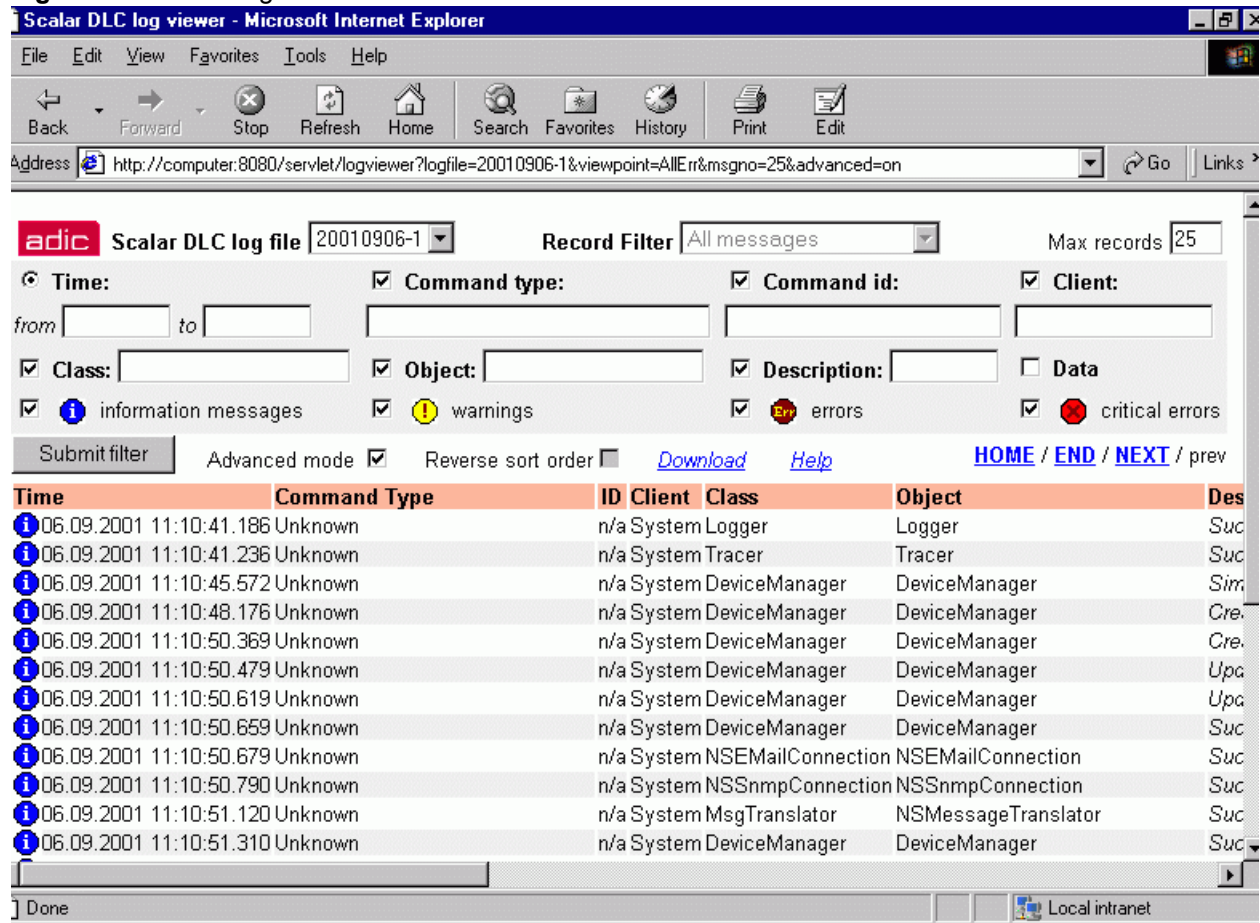

Name	Operation	Description
Time	Check/Enter	Specify the time range of the record to show using the From and To fields. Empty fields specify all records.
Command Type	Check/Enter	Specify the command type of the record to show.
Command Id	Check/Enter	Specify the command ID of the record to show.
Client	Check/Enter	Specify the client of the record to show.
Class	Check/Enter	Specify the class of the record to show.
Object	Click/Enter	Specify the object of the record to show.

Name	Operation	Description
Description	Check/Enter	Specify the description of the record to show.
Data	Check	Specify the record data to show.
Information	Check	Show information messages.
Warnings	Check	Show warning messages.
Errors	Check	Show error messages.
Critical errors	Check	Show critical error messages.

Double-click on the record message to open the log message details window.

Figure 44 Log Message Details

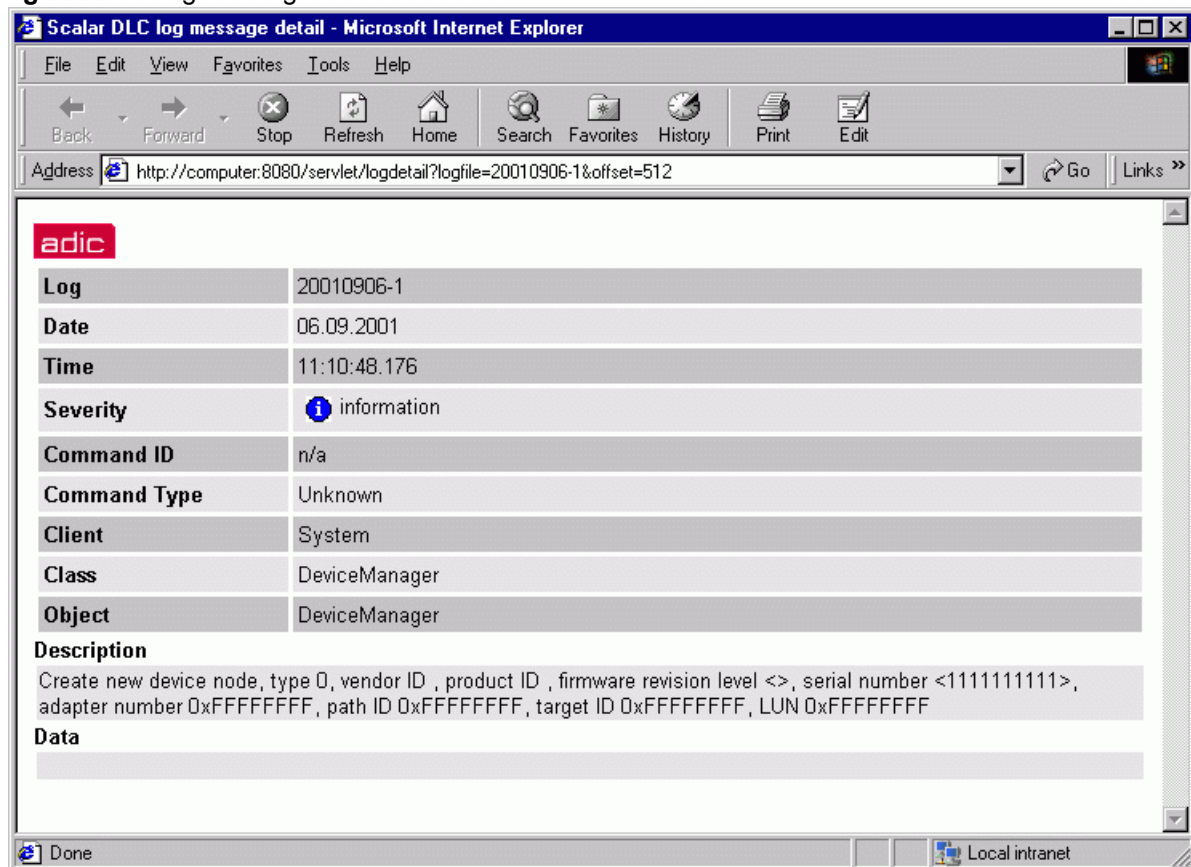

Name	Description
Log	Log file the record message is taken from.
Date	The record date.
Time	The record time.
Severity	The record severity.
Command Id	The record command id.
Command type	The record command type.

Name	Description
Client	The record client.
Class	The record class.
Object	The record object.
Description	The record description
Data	The record additional data.

Help

This section contains the information that can be helpful for the customer.

Options	Name	Description
Help	Help Content	Contains browser-based HTML help files that cover installation, operation, and service. This information appears in a separate window. The contents, index, search engine, and bookmarks are accessed from this window.
Help Contents	License Agreement	A copy of the Scalar DLC software license agreement can be viewed from this pane.
License Agreement	About	The Scalar DLC software and component code versions can be viewed from this pane. All Scalar DLC hot fixes and service packs (if any) are enlisted here, too. See Figure 45 .
About Scalar DLC		

Figure 45 Scalar DLC Software Version Code

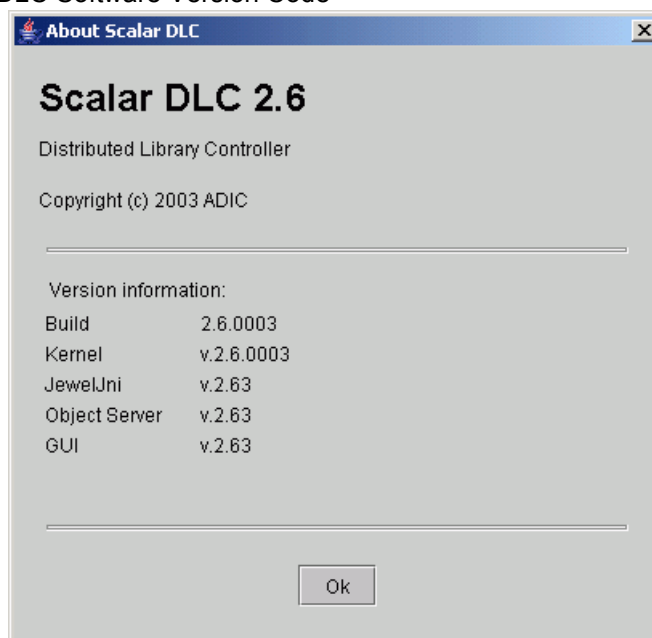

GUI Tabs

This topic describes the main area of the Scalar DLC Management GUI screen, the GUI Tabs. All extended configuration and management is executed from this area.

The detailed structure is described in [Tabs Structure](#) on page 68.

Figure 46 GUI Tabs: Working Areas

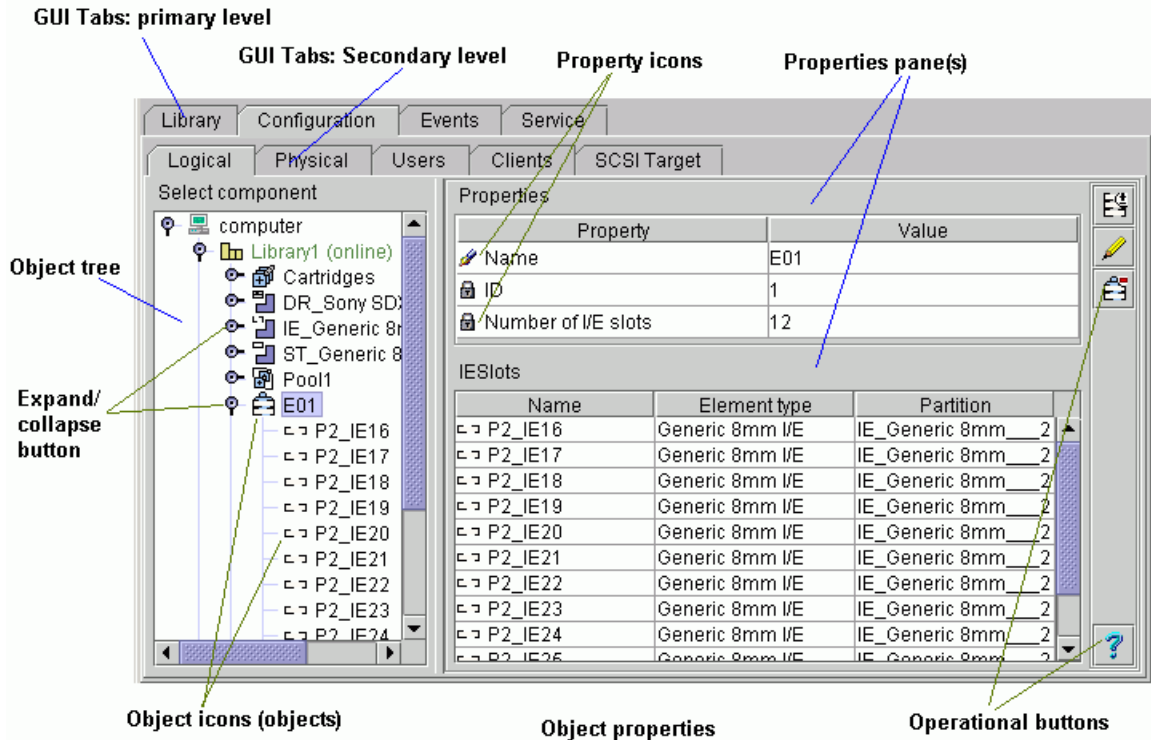

While using the GUI Tabs, clicking the expand/collapse button on the left of the branch in the *Select Components* area of the pane expands or collapses that branch of the tree. Selecting the actual branch displays the associated properties.

 **Note** Expanding the tree does not select branches from the tree.

The top of the tree always indicates the Scalar DLC controller. As each branch of the tree is expanded and selected, the properties for that branch of the tree appear. An explanation of the tree objects is described in [Table 9](#) on page 62.

 **Note** Some elements are present on all the panes of the Scalar DLC Management GUI, while other are not.

Table 9 Tree Objects





















Object	Icon	Color	Description
Controller		<ul style="list-style-type: none"> • Black 	The name (Hostname) of the Scalar DLC server controller. All the example screens of this manual use either computer , or sdiccluster (failover solution).
Logical library		<ul style="list-style-type: none"> • Green • Dark yellow • Red 	The name of the logical library object that represents the actual library to the client. The color of the library indicates the state of the library. The state of the library also is indicated in parenthesis next to the name of the library. Table 10 on page 63 explains the definition of the states.
Physical library		<ul style="list-style-type: none"> • Green • Dark yellow • Red 	The name of the physical tape library device. The color of the library indicates the state of the library. The state of the library also is indicated in parenthesis next to the name of the library. Table 11 on page 64 explains the definition of the states.
Robot		<ul style="list-style-type: none"> • Black • Gray 	The robotic accessor inside the physical device. Most devices contain only one robot (single aisle libraries), however some devices contain two robots (dual aisle libraries). The color of the robot indicates the state of the robot. See Table 12 on page 64.
Partition		<ul style="list-style-type: none"> • Black • Gray 	A segment of Physical library. It contains the continuous range of slots of single type and single media domain. Also the storage partition always contains either linear shelf slots or tower slots, but not both of them even when they have the same media domain and type. The created partition should be assigned to a Logical library. The Logical library should contain at least one storage partition, one mailbox partition, and one drive partition of the same media domain for the complete configuration. In dual aisle libraries, the partition also must be in the range of one robot only. If the robot is offline, its partitions are offline, too. The color of the partition indicates the state of the partition. See Table 13 on page 65.
Scratch pool		<ul style="list-style-type: none"> • Black 	The name of the scratch cartridge pool. Contains the data cartridges available for writing. The pool content may be either the continuous range or a discrete set. Only the cartridges of a single media type can be assigned to the pool.
Clean pool		<ul style="list-style-type: none"> • Black 	The name of the clean cartridge pool. Contains the cleaning cartridges. The pool content may be either the continuous range or a discrete set. Only the cartridges of a single media type can be assigned to the pool.
Cartridges		<ul style="list-style-type: none"> • Black 	This list indicates cartridges currently contained in the library.

Table 9 Tree Objects (Continued)

Object	Icon	Color	Description
Offline cartridges		• Black	This list indicates cartridges that were removed from the physical library and their image is remained for archive purposes.
Data cartridge		• Dark green	For a dark green cartridge text, the list indicates the data cartridges. See Table 19 on page 78 for the details.
Cleaning cartridge		• Dark yellow	For a dark yellow cartridge text, the list indicates the cleaning cartridges. See Table 19 on page 78 for the details.
Storage slots		• Black	This list indicates the storage area in the physical library.
Storage slot		• Blue • Gray	For a blue storage slot name, a cartridge is present in the slot. See Table 14 on page 65.
		• Black • Gray	For a black storage slot name, the slot is empty. See Table 14 on page 65.
Mailbox		• Black	The name of the insert/eject area of the logical library. Contains a set of insert/eject slots that are also called mailboxes or mailbox slots. The mailbox content may be either a continuous slot range or a discrete set.
Mailboxes		• Black	This list indicates the whole mailbox (insert/eject) area in the physical library.
Mailbox slot		• Blue • Gray	For a blue mailbox slot name, a cartridge is present in the slot. See Table 15 on page 66.
		• Black • Gray	For a black mailbox slot name, the slot is empty. See Table 15 on page 66.
Drives		• Black	This area contains the drive slots for executing the read/write operations
Drive slot		• Blue • Gray	For a blue drive slot name, a cartridge is present in the slot. See Table 16 on page 67.
		• Black • Gray	For a black drive slot name, the slot is empty. See Table 16 on page 67.

The following tables describe the states and properties of the objects mentioned above.

Table 10 Logical Library States













State	Icon	Color	Description
Online		Green	The library is online and accepts all commands
Online, alarm ^a		Green	The library is online and accepts all commands. An error has been encountered.

Table 10 Logical Library States

State	Icon	Color	Description
Diagnostic (Service)		Dark yellow	Either the library diagnostic or the firmware update is being executed.
Disabled		Dark yellow	The library is logically switched off (Home operation executed).
Invalid		Red	The library configuration is invalid (one or more required partition(s) missing).
Not ready		Red	The library is not available (either the connection is lost or the admin has manually changed the library state).

a. Alarm flag indicates that an error has occurred but it does not specify the error. To find out what has happened, use the Log Viewer, as described in [Log Viewer Utility](#) on page 221.

Table 11 Physical Library States

State	Icon	Color	Description
Online		Green	The library is online and accepts all commands
Online, alarm ^a		Green	The library is online and accepts all commands. An error has been encountered.
Diagnostic		Dark yellow	The library diagnostic is being executed.
Service		Dark yellow	The library is in service mode (firmware update process is being executed).
Not ready		Red	The library is not ready (service needed).
Offline		Red	The library is offline (connection lost).

a. Alarm flag indicates that an error has occurred but it does not specify the error. To find out what has happened, use the Log Viewer, as described in [Log Viewer Utility](#) on page 221.

Table 12 Robot States



State	Icon	Color	Description
Normal (Online)		Black	The robot is online and functioning. All elements and slots of the robot are accessible.
Offline		Gray	The robot is offline. All elements and slots of the robot are temporary not accessible.

Table 13 Partition Class and State







Class and State	Icon	Color	Description
Storage, online		Black	Contains the continuous range of storage slots that are either the linear storages or the tower storages. The robot is online.
Storage, offline		Gray	Contains the continuous range of storage slots that are either the linear storages or the tower storages. The robot is offline.
Import/Export, online		Black	Contains the continuous range of mailbox slots. The robot is online.
Import/Export, offline		Gray	Contains the continuous range of mailbox slots. The robot is offline.
Drive, online		Black	Contains the continuous range of drives. The robot is online.
Drive, offline		Gray	Contains the continuous range of drives. The robot is offline.

Table 14 Storage Slots























State	Icon	Color	Description
Occupied, online		Blue	The slot contains a cartridge. The robot is online.
Occupied, offline		Gray	The slot contains a cartridge. The robot is offline.
Occupied, online, alarm ^a		Blue	The slot contains a cartridge. The robot is online. An error is encountered (for example, the robot did not get a cartridge).
Occupied, offline, alarm		Gray	The slot contains a cartridge. The robot is offline. An error is encountered (for example, the robot did not get a cartridge).
Empty, online		Black	The slot is empty and free. The robot is online.
Empty, offline		Gray	The slot is empty and free. The robot is offline.
Empty, online, alarm		Black	The slot is empty and free. The robot is online. An error is encountered (for example, the robot did not put a cartridge).
Empty, offline, alarm		Gray	The slot is empty and free. The robot is offline. An error is encountered (for example, the robot did not put a cartridge).
Home position, online		Black	The slot is empty but it remains a home position of a cartridge that is currently in a drive or mailbox slot. The robot is online.

Table 14 Storage Slots (Continued)

State	Icon	Color	Description
Home position, offline		Gray	The slot is empty but it remains a home position of a cartridge that is currently in a drive or mailbox slot. The robot is offline.
Not available		Gray	The slot is currently unavailable (for example, tower door is opened).











a. Alarm flag indicates that an error has occurred but it does not specify the error. To find out what has happened, use the Log Viewer, as described in [Log Viewer Utility](#) on page 221.

Table 15 Mailbox Slots

State	Icon	Color	Description
Occupied, online		Blue	The slot contains a cartridge. The robot is online.
Occupied, offline		Gray	The slot contains a cartridge. The robot is offline.
Occupied, online, alarm ^a		Blue	The slot contains a cartridge. The robot is online. An error is encountered (for example, the robot did not get a cartridge).
Occupied, offline, alarm		Gray	The slot contains a cartridge. The robot is offline. An error is encountered (for example, the robot did not get a cartridge).
Empty, online		Black	The slot is empty and free. The robot is online.
Empty, offline		Gray	The slot is empty and free. The robot is offline.
Empty, online, alarm		Black	The slot is empty and free. The robot is online. An error is encountered (for example, the robot did not put a cartridge).
Empty, offline, alarm		Gray	The slot is empty and free. The robot is offline. An error is encountered (for example, the robot did not put a cartridge).
Home position, online		Black	The slot is empty but it remains a home position of a cartridge that is currently in a drive slot. The robot is online.
Home position, offline		Gray	The slot is empty but it remains a home position of a cartridge that is currently in a drive slot. The robot is offline.
Not compatible		Gray	The slot is not compatible with the library.
Missing		Gray	The slot is physically missing.

a. Alarm flag indicates that an error has occurred but it does not specify the error. To find out what has happened, use the Log Viewer, as described in [Log Viewer Utility](#) on page 221.





Table 16 Drive Slots

State	Icon	Color	Description
Occupied, online		Blue	The slot contains a cartridge. The robot is online
Occupied, offline		Gray	The slot contains a cartridge. The robot is offline
Occupied, online, alarm ^a		Blue	The slot contains a cartridge. The robot is online. An error is encountered (for example, the robot did not dismount a cartridge).
Occupied, offline, alarm		Gray	The slot contains a cartridge. The robot is offline. An error is encountered (for example, the robot did not dismount a cartridge).
Empty, online		Black	The slot is empty and free. The robot is online.
Empty, offline		Gray	The slot is empty and free. The robot is offline.
Empty, online, alarm		Black	The slot is empty and free. The robot is online. An error is encountered (for example, the robot did not load a cartridge).
Empty, offline, alarm		Gray	The slot is empty and free. The robot is offline. An error is encountered (for example, the robot did not load a cartridge).
Not available		Gray	The slot is unavailable.
Not installed		Gray	The slot is not installed.

a. Alarm flag indicates that an error has occurred but it does not specify the error. To find out what has happened, use the Log Viewer, as described in [Log Viewer Utility](#) on page 221.





The panes of element properties contain the property icons ([Table 17](#)).

Table 17 Element Properties: Icons

Property	Icon	Operation	Description
Read-only		Supplied	The property or field is read-only and cannot be edited.
Editable		Enter	The property can be edited, checked, or selected. The icon is typically used for text fields, check boxes, and combo boxes.
		Select	
		Check	
Disabled		Supplied	The property cannot be edited until another field is selected or checked. Then becomes editable.
Forbidden		Supplied	The user is not authorized to change the property.

Some Management GUI panes and pop-up windows also contain the typical operational buttons listed in [Table 18](#) (either all these buttons or several buttons or only one of them).

Table 18 Operational Buttons

Button	Icon	Operation	Description
OK/Create		Click	<ul style="list-style-type: none"> Create object (creation panes). Execute operation.
Cancel/Terminate		Click	<ul style="list-style-type: none"> Cancel operation. Close pop-up pane without creating an object. Close pop-up pane without executing an operation.
Save/Update		Click	<ul style="list-style-type: none"> Save the element properties after edit.
Help		Click	<ul style="list-style-type: none"> Open online help for the current pane.

Tabs Structure

The internal structure of the Scalar DLC Management GUI tabs is summarized in the following list.

- Library Tab. Main operating area. Refer to [Library Tab](#) on page 71.
- Configuration Tab. Managing and reviewing the library, SCSI Target, client, and user configuration. Refer to [Configuration Tab](#) on page 87.
 - Logical Tab. Managing library logical configuration, cartridges, pools, mailbox areas, drives. Refer to [Logical Tab](#) on page 88.
 - Physical Tab. Managing the physical library and the library partitions. Refer to [Physical Tab](#) on page 112.
 - Users Tab. Managing user parameters. Refer to [Users Tab](#) on page 128.
 - Clients Tab. Managing clients. Refer to [Clients Tab](#) on page 134.
 - SCSI Target Tab. Managing SCSI Targets and LUNs. Refer to [SCSI Target Tab](#) on page 162.
- Events Tab. Managing the command queue and the created rules, monitoring the system events and acknowledging the notifications. Refer to [Events Tab](#) on page 173.
 - Queue Tab. Managing command queue. Refer to [Queue Tab](#) on page 174.
 - Monitoring Tab. Monitoring the current login session events. Refer to [Monitoring Tab](#) on page 176.
 - Acknowledge Tab. Acknowledging the notifications. Refer to [Acknowledge Tab](#) on page 178.
 - History Tab. Monitoring the events during all sessions. Refer to [History Tab](#) on page 179.
 - Rules Tab. Managing the rules. Refer to [Rules Tab](#) on page 179.
- Service Tab. Executing library diagnostics, view hardware logs, managing service request (tickets), command panel, and cluster. Refer to [Service Tab](#) on page 183.
 - Logs Tab. Monitoring the library command log and error log. Refer to [Logs Tab](#) on page 183.
 - Diagnostic Tab. Executing the library diagnostics. Refer to [Diagnostic Tab](#) on page 187.
 - ATAC Calls Tab. Managing the service requests (tickets). Refer to [ATAC Calls Tab](#) on page 189.

- Operator Panel Tab. Executing operator panel commands from a remote console. Refer to [Operator Panel Tab](#) on page 195.
- Cluster Tab. Viewing and changing the cluster settings. Refer to [Cluster Tab](#) on page 198.
- SNMP Tab. Managing the SNMP settings. Refer to [SNMP Tab](#) on page 199.

The details for each tab are described in the appropriate sections.

GUI Log

The GUI Log is located at the bottom portion of the screen. It shows the list of messages that reflects the operations executed in the Management GUI during the current session. Use the scroll bar if the list is large or the message is long.





 **Note** The GUI Log does not reflect the operations executed from a client side.

Figure 47 GUI Log

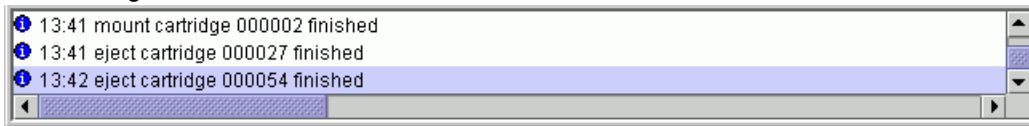

Icon	Description
	Indicates that the current message contains an information message.
	Indicates that the current message contains a warning message.
	Indicates that the current message contains an error message.

5

Library Tab

The Library Tab is the main operational area. All media move commands and most logical library monitoring is executed from this tab.



Note

The Library Tab is accessible for all users. Some move commands require additional rights.

As the Library Tab is opened, in the *Select Components* area of the pane the Controller appears.

Figure 48 Library Controller

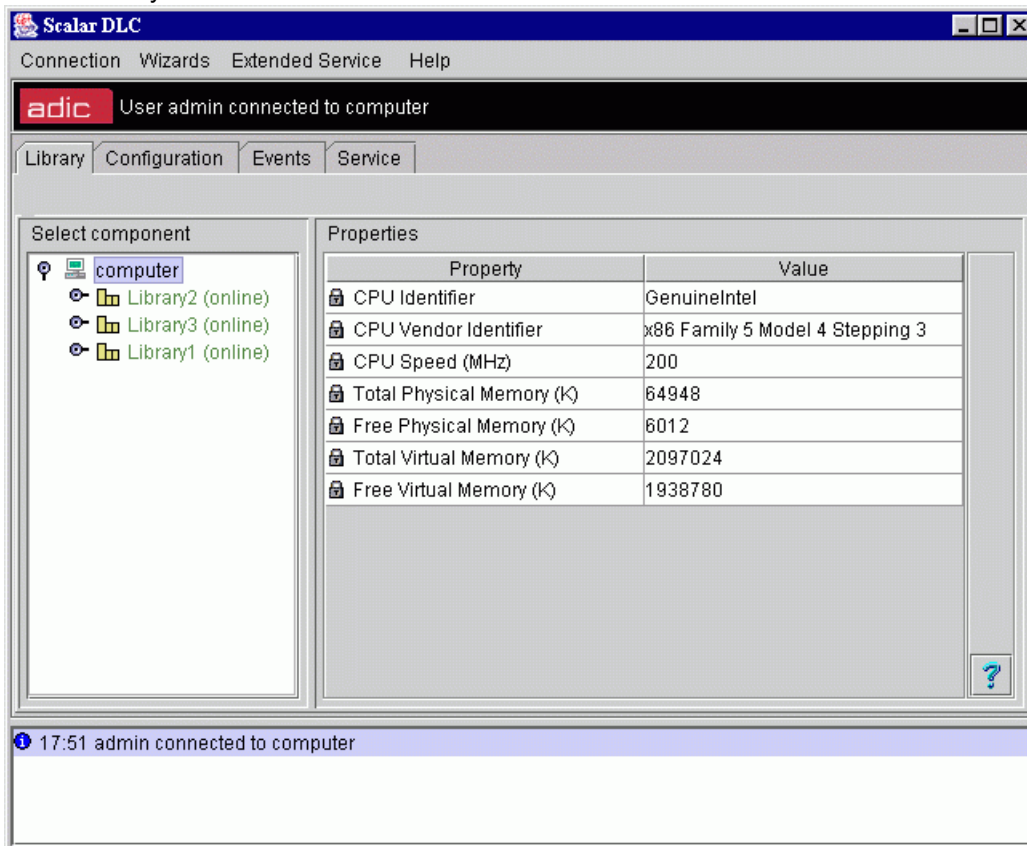

Field/Button	Icon	Operation	Description
CPU Identifier		Supplied	The CPU identifier.
CPU Vendor ID		Supplied	The CPU vendor identifier.
CPU Speed		Supplied	The CPU speed.
Total Physical Memory		Supplied	The total physical memory size.
Free Physical Memory		Supplied	The free physical memory size.
Total Virtual Memory		Supplied	The total virtual memory size.
Free Virtual Memory		Supplied	The free virtual memory size.
Help		Click	Open online help for the current pane.

Library

The Library Properties pane (right) contains two tab panes: *Properties*, with the library properties (refer to [Library Properties](#) on page 73), and the *Diagnostics*, with the diagnostic information for the selected library (refer to [Library Diagnostics](#) on page 74).

Library Properties

Figure 49 Library Properties

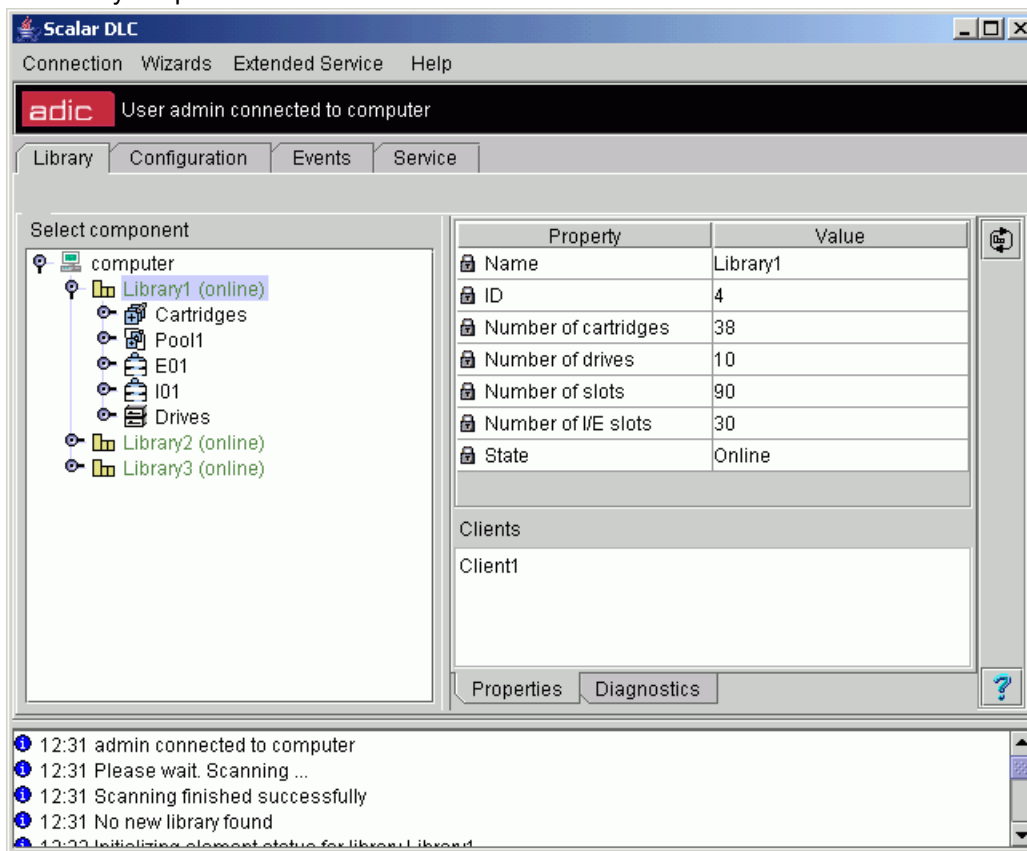

Field/Button	Icon	Operation	Description
Name		Supplied	Logical library name.
ID		Supplied	Logical library identification number.
Number of cartridges		Supplied	Number of available cartridges.
Number of drives		Supplied	Number of available drives.
Number of slots		Supplied	Number of available storage slots.
Number of I/E slots		Supplied	Number of available mailbox slots.
State		Supplied	Logical library state. See Table 10 on page 63.
Clients		Supplied	The clients attached to the logical library.

Field/Button	Icon	Operation	Description
Inventory ^a		Click	Initialize all the library elements and assign home positions if necessary. See Figure 3 on page 5.
Help		Click	Open online help for the current pane.

- a. The physical library is covered with a set of partitions. These partitions are assigned to some logical libraries. A single partition can be assigned to two or more logical libraries. It is in the concepts of the Scalar DLC. Such apparitions are called “shared”, and the inventory operation affects all partitions assigned to the logical library.



Note If a new library has been created, an **inventory** must be executed to avoid problems with the cartridge home positions.





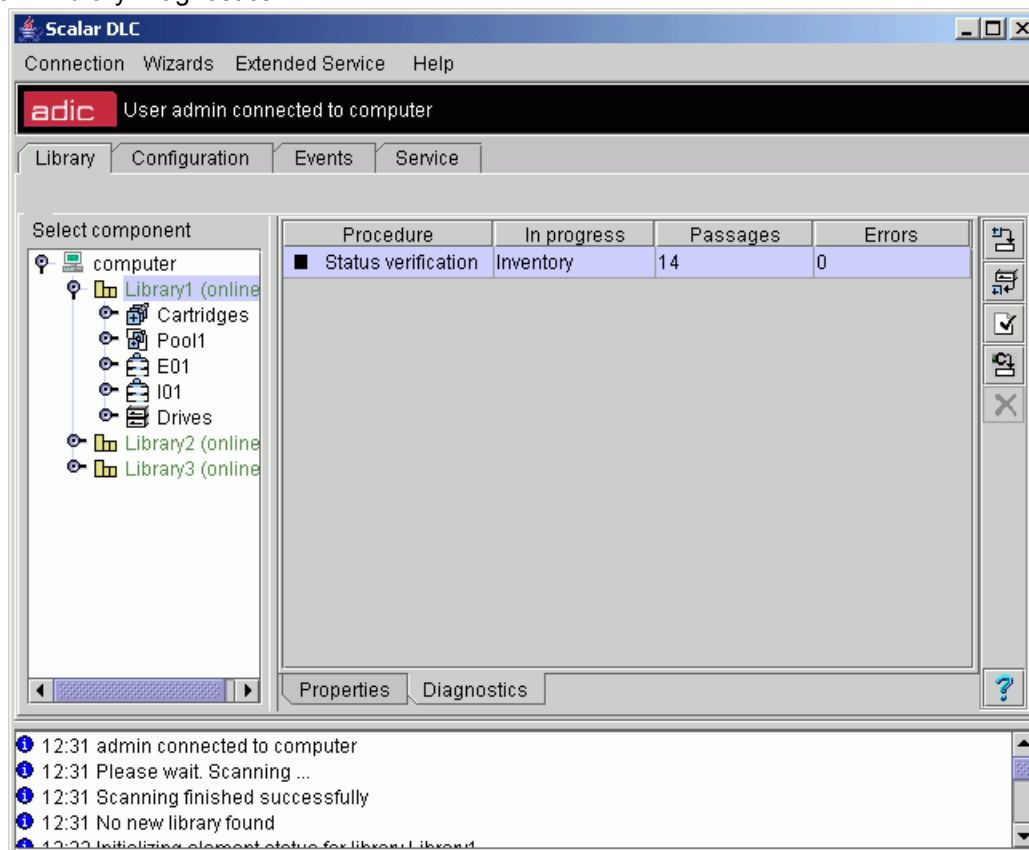

Library Diagnostics

Figure 50 Library Diagnostics



The *Diagnostics* pane is designed for testing purposes.

Field/Button	Icon	Operation	Description
Procedure		Supplied	The global test procedure.
In progress		Supplied	The test step currently in progress.
Passages		Supplied	Number of passages.

Field/Button	Icon	Operation	Description
Errors		Supplied	Number of errors, if any.
Random move test		Click	Launch Random move test. Refer to Random Move Test on page 75.
Mount test		Click	Launch Random mount test. Refer to Random Mount Test on page 76.
Element status verification test		Click	Launch Inventory test. This test initializes element status command for the logical library and verifies whether the starting picture of the library corresponds the picture received (total number of elements, empty elements, occupied slots, etc.). Any single operation is inventory command.
Element position test		Click	Launch Move Gripper test. This test initializes move gripper command, it randomly moves the robot gripper to any slot assigned to the logical library and checks the element position. No media is moved within this test.
Terminate		Click	Stop current test. The temporary warning pane appears, see Figure 51 .
Help		Click	Open online help for the current pane.



CAUTION

Running Library diagnostic tests must not be executed when any of the clients use the library because this testing will interfere the client work.



CAUTION

All Library diagnostic tests are cyclic, when started, they are executed endlessly until the Admin stops diagnostics by the Cancel button (see [Figure 51](#)).

Figure 51 Stop Current Test

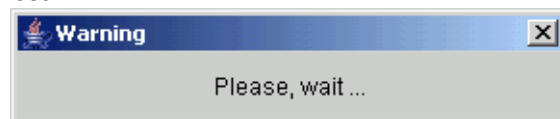

Random Move Test

Figure 52 Random Move: Select Media Type

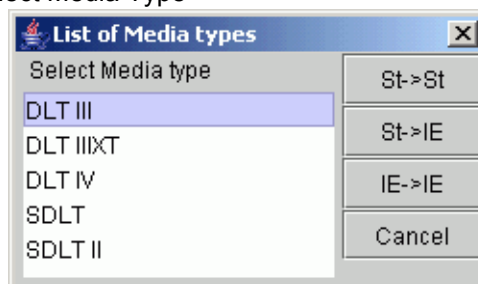

This test moves the cartridges of the selected media type either from Storage to Storage, or from Storage to I/E (and vice versa), or from I/E to I/E. Any single operation is **move** command (refer to [Move Cartridge to Element](#) on page 80), the cartridge and target slot are selected at random by media type.

Random Mount Test

Figure 53 Random Mount: Select Media Type

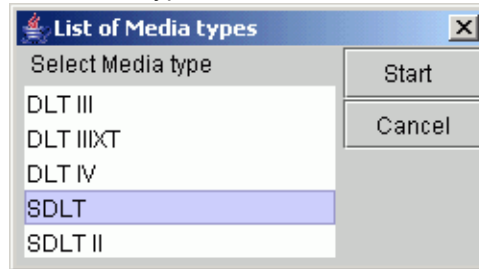

This test mounts the cartridges of the selected media type and dismounts them from drives. Any single operation is **mount** or **dismount** command, the cartridge and target drive are selected at random by media type.

Cartridges

In the *Select Components* area of the pane, selectable Cartridges are displayed. Clicking the expand/collapse button causes an element expansion.

Figure 54 Cartridges

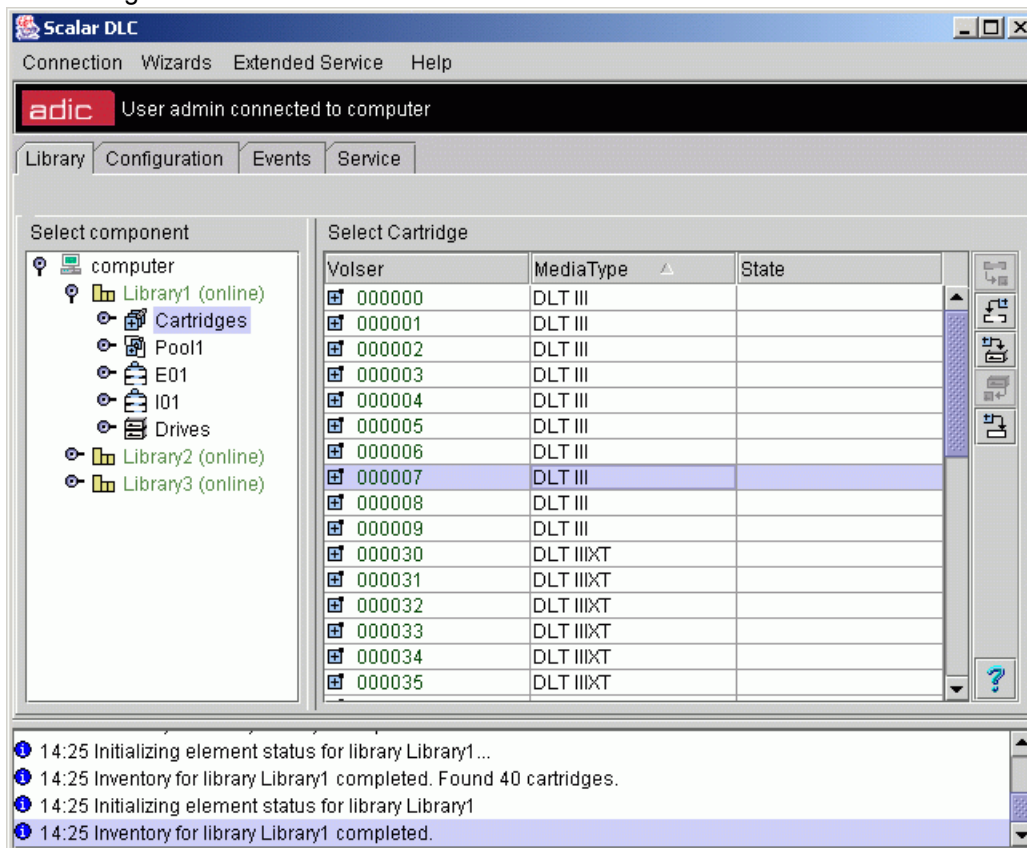

Field/Button	Icon	Operation	Description
Volser		Select	The volume serial number, a cartridge name. Each cartridge has one volser. The optical disks are represented with two cartridges because each optical disk has two volsers.
Media Type		Select	Cartridge media type. Refer to Media Types on page 246.
State		Select	A cartridge state, empty means <i>stored</i> . Refer to Cartridge State on page 78.
Import		Click	Transfer the cartridge from a mailbox slot to a storage area. The target slot is a cartridge home position. The button is enabled for a cartridge stored in a mailbox.
Export		Click	Transfer the cartridge to a mailbox. If more than one mailbox exists, an additional export selection appears. See Figure 55 . Select an appropriate mailbox from the combo box. This operation saves the cartridge home position. The button is enabled for a cartridge not in a mailbox, when a mailbox exist.
Mount		Click	Insert a cartridge into the first available tape drive of the appropriate media type (Generic Mount). The button is enabled for a stored cartridge.
Dismount		Click	Move a cartridge from a tape drive to the cartridge home position. This button is enabled for a mounted cartridge.
Move		Click	Open a pop-up Move window. Refer to Move Cartridge to Element on page 80. The move operation transfers a cartridge from its current position to a selected destination slot.
Help		Click	Open online help for the current pane.

By default, the cartridges are sorted by media type, in ascending order. Click on the appropriate column title to change the sorting order.

To select cartridge for the operation, click on it. <Ctrl>+Click allows multiple cartridge selection, for the multiple **Export/Import** operations. Multiple **Mount/Dismount/Move** operations are not allowed in the Scalar DLC Management GUI.

Figure 55 Multiple Mailbox Selection



After a cartridge has been moved to the mailbox slot through the **Export** command and become *ejected*, it cannot be manipulated again until **Inventory** has been completed. After an **inventory** is completed, the cartridges are recognized as *stored*.

The Management GUI also allows drag and drop cartridge operations. Refer to [Drag and Drop Operations](#) on page 81.

Cartridge State

The cartridges contained in the library have a different state. The state indicates a cartridge availability to accept commands, and so forth.

Table 19 Cartridge States

Cartridge state	Command status	Icon	Description
Stored (shown as empty)	Active		The cartridge is stored in mailbox or in storage slot. A cartridge in a storage slot is active for Move , Mount and Export operations, a cartridge in a mailbox slot is active for Move , Mount and Import operations.
Mounted	Active		The cartridge is moved to the drive slot and is ready for the read/write operations. The cartridge is active for Move , Export and Dismount operations.
Reverse mounted	Not active		The optical disk is moved to the drive, and its other side is ready for the read/write operations. The cartridge is not active until the Dismount is done.
Ejected	Not active		The cartridge is exported into a mailbox slot, and a home position has been saved. The cartridge is not active for any operations until the Inventory is finished.
Unloaded	Not active		The cartridge is exported into a mailbox slot, and a home position is lost. The cartridge is not active for any operations until the Inventory is finished.
In problem box	Not active		The cartridge is moved to a problem box. The cartridge is not active for any operation and remains not active after the Inventory . Operator can only physically remove this cartridge from the library (a home position will be lost then).
Offline	Not active		The cartridge is removed from the library. The cartridge was not found after the Inventory has been executed.
Being ejected	Not active		The cartridge is moving into a mailbox slot. No commands are accepted. Temporary state.
Being inserted	Not active		The cartridge is moving from the mailbox slot. No commands are accepted. Temporary state.

Table 19 Cartridge States (Continued)

Cartridge state	Command status	Icon	Description
Being mounted	Not active		The cartridge is moving to a drive slot. No commands are accepted. Temporary state.
Being reverse mounted	Not active		The optical disk is moving to a drive slot. After the operation is executed, the cartridge will be <i>reverse mounted</i> . No commands are accepted. Temporary state.
Being moved	Not active		The cartridge is moving to another slot (low-level command is being executed). No commands are accepted. Temporary state.
Being dismounted	Not active		The cartridge is moving from the drive slot. No commands are accepted. Temporary state.
Being reverse dismounted	Not active		The optical disk is moving from a drive slot. The cartridge was <i>reverse mounted</i> . No commands are accepted. Temporary state.
Being flipped	Not active		The optical disk in drive slot is being flipped. If the cartridge state was <i>mounted</i> , after the operation is executed it will be <i>reverse mounted</i> , and vice versa. No commands are accepted. Temporary state.
Being in problem box	Not active		The cartridge is moving to a problem box. No commands are accepted. Temporary state.

If the cartridge is not found in the library after the **Inventory** has been executed, its state changes to *offline*. After that, the cartridge is removed from the Cartridge list of Logical library (both **Library** tab and **Configuration > Logical** tab, **Cartridges**) and goes to archive list, or the list of the offline cartridges. It is shown under the **Physical** tab of the **Configuration** area and contains the information about cartridges that were removed from the physical library. Refer to [Offline Cartridge](#) on page 121.

Home Position

The cartridge home position concept is a basis of cartridge move operations in the Scalar DLC Management software. Every cartridge impoting in the library immediately gets a home position in the first free storage slot of appropriate type (for example, Generic DLT slot for DLT IV or SDLT cartridges; refer to [Storage Types](#) on page 247 for the details). Each cartridge has one and only home position. The slot can be a home position for one and only one cartridge (the only exception is optical disk — the two sides of an optical disk are represented with two volsers and one home position is assigned to both sides).



CAUTION

Always import cartridges when they are first appeared in the mailbox area. Otherwise there could be issues with a cartridge home position being the mailbox slot.

After the home position is assigned to the cartridge, it becomes available for move operations. The **Import** operation inserts the cartridge from a mailbox to the home position; the **Dismount** operation moves the cartridge from a drive to the home position. If the **Mount** operation has been executed and the cartridge is moved to a drive, the home position is saved and cannot be occupied by another cartridge. If the **Export** operation has been executed, the cartridge is ejected from the library and becomes unavailable. However, it saves the home position and if the **Inventory** operation finds the ejected cartridge, it becomes available again. Refer to [Table 19](#) on page 78.

The cartridge relinquishes the home position only after the **eject complete** operation is executed from a client side. The cartridge state is *unloaded* then. Refer to [Table 19](#) on page 78.

The home position cannot be changed after it is assigned. Every operation returning the cartridge to a library storage area puts it into the home position. The only exception is the **Move** operation (it can be executed from a client side as well); if the move destination is a storage slot, it will become a new home position of a cartridge. The old home position is lost in that event.



CAUTION

The DAS and ROBAR clients mostly use the analog of Mount, Dismount, Import, and Export commands, although they can execute Move command, too. The SCSI clients use Move command only and therefore do not have the home position-related features.

Move Cartridge to Element

The **Move** operation transfers a cartridge from its current position to a selected destination. If the move destination is a storage slot, it will become a new home position of a cartridge. The old home position is lost then. Refer to [Home Position](#) on page 79 for details.

After the **Move** button is pressed, a Move Cartridge to Destination pop-up window appears.



Note

This operation is allowed only for the users with *Expert move* rights.

Figure 56 Move Cartridge to Destination

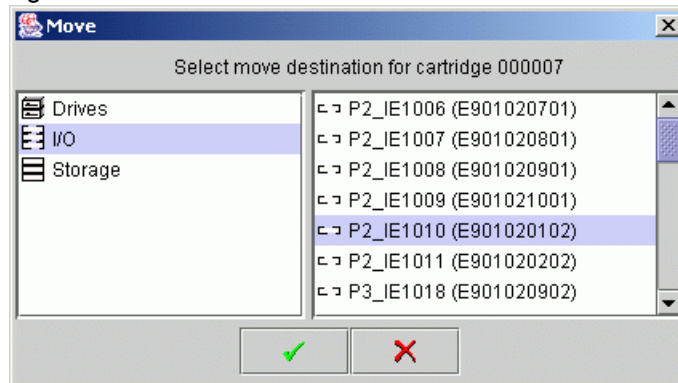

Select the destination area on the left. The list of slots for this area will be shown on the right (both partition-name and LSCI coordinates are indicated).

**Note**

Only available slots are shown that means they are to be compatible, empty, and not marked as a home position for another cartridge. The destination and target slot can be the same element.

For the 3590 cartridge the target can be only 3590-compatible slot; refer to [Storage Types](#) on page 247, [Mailbox Types](#) on page 248, and [Drive Types](#) on page 249).

Select the slot and press **OK** to complete the move operation. Press **Cancel** to exit without executing a move.

Drag and Drop Operations

Drag and Drop operation mostly serves the same function as the **Import**, **Export**, **Mount**, and **Dismount** buttons. However there are some extestions (described below).

Drag source	Source Status	Drop target	Operation
Cartridge	Mounted	Library	Dismount
Cartridge	Stored	Drives	Generic Mount
Cartridge	Stored	Drive	Mount to the specified drive
Cartridge	Mounted or stored in Storage slot	Mailbox	Export to the specified Mailbox
Cartridge	Stored in I/E slot	Mailbox	Move to the specified Mailbox, the cartridge remains stored
Drive slot	Occupied	Mailbox	Export the cartridge to the specified Mailbox
Drive slot	Occupied	Cartridges	Dismount drive
Drive slot	Occupied	Library	Dismount drive
Drive slot	Occupied	No target	Dismount drive
Mailbox	-	Library	Import the entire contents of the Mailbox

Pool



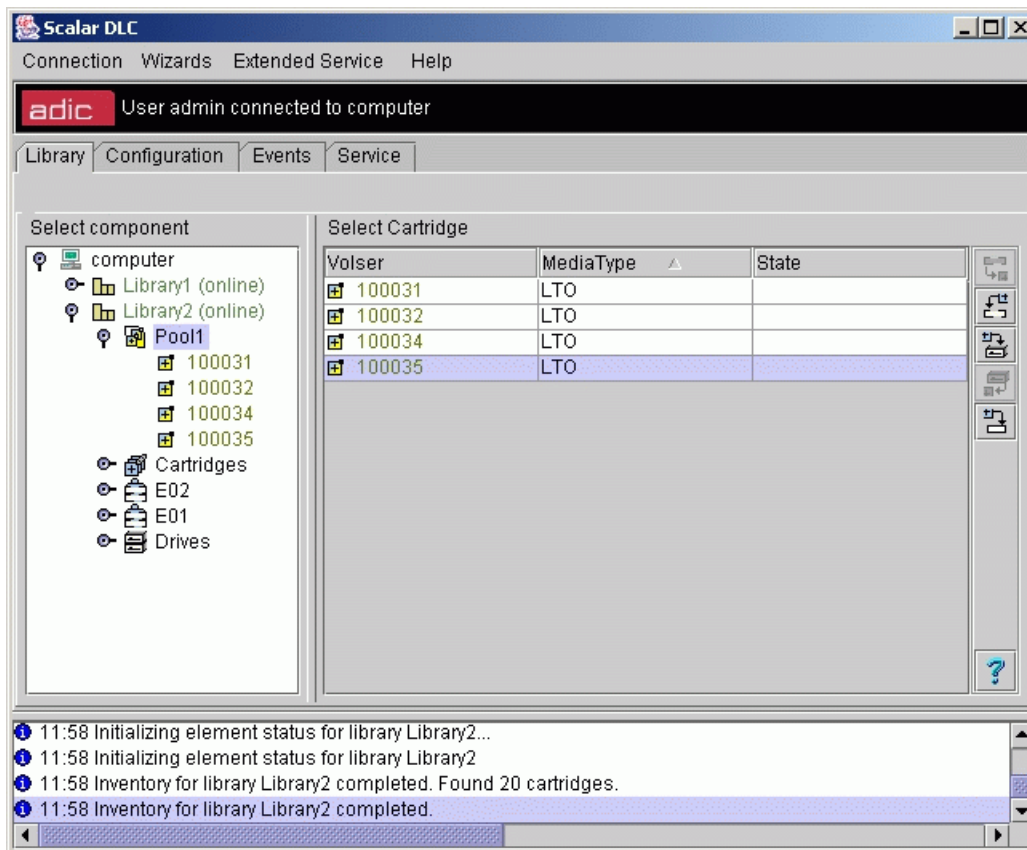

In the *Select Components* area of the pane, selectable Pools appear. Clicking the expand/collapse button causes an element expansion.

Figure 57 Pool



The pool contains a set of cartridges, so the pool properties and operational buttons are the same as those of a cartridge.

Field/Button	Icon	Operation	Description
Volser		Select	The volume serial number, a cartridge name. Each cartridge has one volser. The optical disks are represented with two cartridges because each optical disk has two volsers.
Media Type		Select	Cartridge media type. Refer to Media Types on page 246.
State		Select	A cartridge state, empty means <i>stored</i> . Refer to Cartridge State on page 78.
Import		Click	Transfer the cartridge from a mailbox slot to a storage area. The target slot is a cartridge home position. The button is enabled for a cartridge stored in a mailbox.

Field/Button	Icon	Operation	Description
Export		Click	Transfer the cartridge to a mailbox. If more than one mailbox exists, an additional export selection appears. See Figure 55 . Select an appropriate mailbox from the combo box. This operation saves the cartridge home position. The button is enabled for a cartridge not in a mailbox, when a mailbox exist.
Mount		Click	Insert a cartridge into the first available tape drive of the appropriate media type (Generic Mount). The button is enabled for a stored cartridge.
Dismount		Click	Move a cartridge from a tape drive to the cartridge home position. This button is enabled for a mounted cartridge.
Move		Click	Open a pop-up Move window. Refer to Move Cartridge to Element on page 80. The move operation transfers a cartridge from its current position to a selected destination slot.
Help		Click	Open online help for the current pane.

By default, the cartridges are sorted by media type, in ascending order. Click on the appropriate column title to change the sorting order.

To select a cartridge for the operation, click on it. <Ctrl>+Click allows multiple cartridge selection, for the multiple **Export/Import** operations. Multiple **Mount/Dismount/Move** operations are not allowed in the Scalar DLC Management GUI.

Mailbox

In the *Select Components* area of the pane, selectable Mailboxes appear. Clicking the expand/collapse button causes an element expansion.

Figure 58 Mailbox

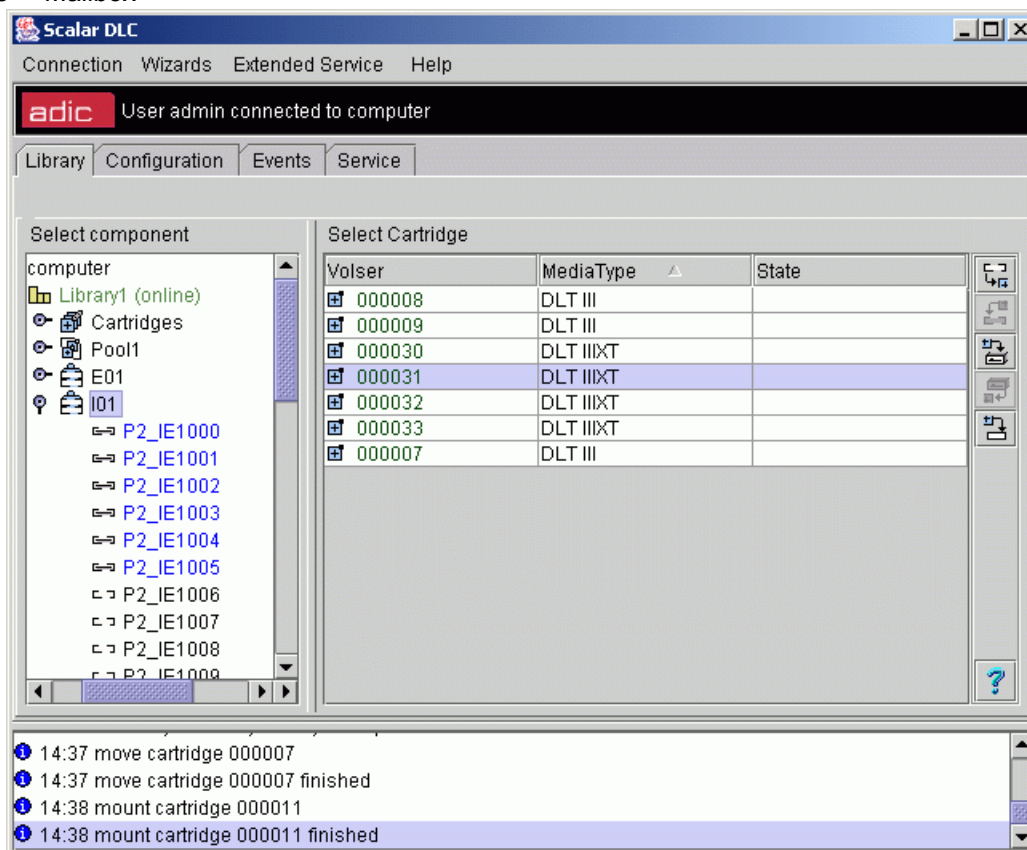

Field/Button	Icon	Operation	Description
Volser		Select	The volume serial number, a cartridge name. Each cartridge has one volser. The optical disks are represented with two cartridges because each optical disk has two volsers.
Media Type		Select	Cartridge media type. Refer to Media Types on page 246.
State		Select	A cartridge state, empty means <i>stored</i> . Refer to Cartridge State on page 78 for the details.
Import		Click	Transfer the cartridge from mailbox slot to a storage area. The target slot is a cartridge home position. The button is enabled for a cartridge stored in a mailbox.
Export		Click	Disabled for a mailbox.
Mount		Click	Insert a cartridge into the first available tape drive of the appropriate media type (Generic Mount). The button is enabled for a stored cartridge.
Dismount		Click	Disabled for a mailbox.

Field/Button	Icon	Operation	Description
Move		Click	Open a pop-up Move window. Refer to Move Cartridge to Element on page 80. The move operation transfers a cartridge from its current position to a selected destination slot.
Help		Click	Open online help for the current pane.

By default, the cartridges are sorted by media type, in ascending order. Click on the appropriate column title to change the sorting order.





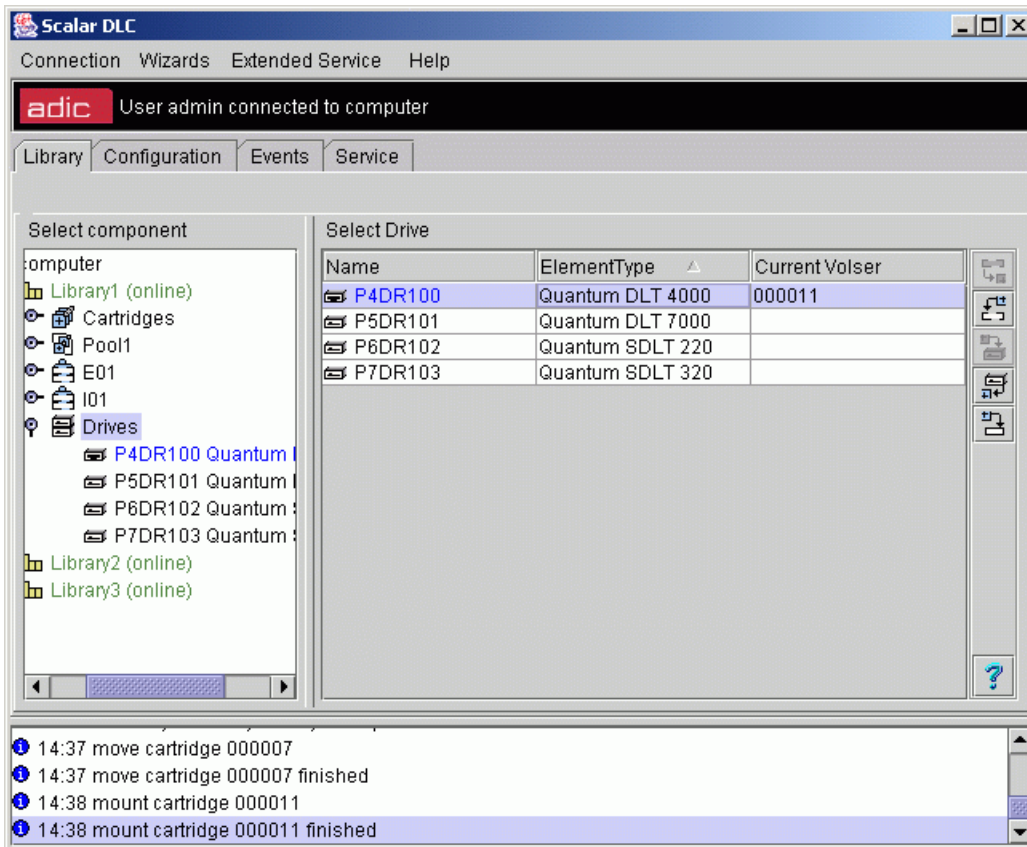

To select cartridge for the operation, click on it. <Ctrl>+Click allows multiple cartridge selection, for the multiple **Import** operations. Multiple **Mount/Move** operations are not allowed in the Scalar DLC Management GUI.

Drives

In the *Select Components* area of the pane, selectable Drives are displayed. Clicking the expand/collapse button results in an element expansion.

Figure 59 Drives



Field/Button	Icon	Operation	Description
Name		Select	The drive name. An icon also indicates the drive state. See Table 16 on page 67.
Element Type		Select	A drive type. Refer to Drive Types on page 249.
Current volser		Select	If the drive is occupied, a contained cartridge is shown. For the optical disk two cartridges are shown, active side first.
Import		Click	Disabled for a drive.
Export		Click	Transfer the cartridge to a mailbox. If more than one mailbox exists, an additional export selection appears. See Figure 55 on page 77. The user selects the appropriate mailbox from the combo box. This operation saves the cartridge home position. The button is enabled when a mailbox exists.
Mount		Click	Disabled for a drive.
Dismount		Click	Move a cartridge from a tape drive to the cartridge home position. This button is enabled for a mounted cartridge.
Move		Click	Open a pop-up Move window. Refer to Move Cartridge to Element on page 80. The move operation transfers a cartridge from its current position to a selected destination slot.
Help		Click	Open online help for the current pane.

By default, the drives are sorted by element type, in ascending order. Clicking on the appropriate column title will change the sorting order.

To select drive for the operation, click on it. <Ctrl>+Click allows multiple drive selection, for the multiple **Export** operations. Multiple **Dismount/Move** operations are not allowed in the Scalar DLC Management GUI.

6

Configuration Tab

The Configuration Tab is designed to view and update the configuration of the various Scalar DLC system components. The Configuration Tab contains an additional level with the following tabs:

- Logical Tab. Managing library logical configuration, cartridges, pools, mailbox areas, drives. Refer to [Logical Tab](#) on page 88.
- Physical Tab. Managing the physical library and the library partitions. Refer to [Physical Tab](#) on page 112.
- Users Tab. Managing user parameters. Refer to [Users Tab](#) on page 128.
- Clients Tab. Managing clients. Refer to [Clients Tab](#) on page 134.
- SCSI Target Tab. Managing SCSI Targets and LUNs. Refer to [SCSI Target Tab](#) on page 162.



Note

The Configuration Tab is accessible for all users. Create, update, and remove functions are available only for the users with administrative rights.

Logical Tab

The Logical Tab pane describes the configuration of a logical library and shows the logical element properties. The starting Logical pane shows the properties of Scalar DLC host PC.

Figure 60 Logical Controller

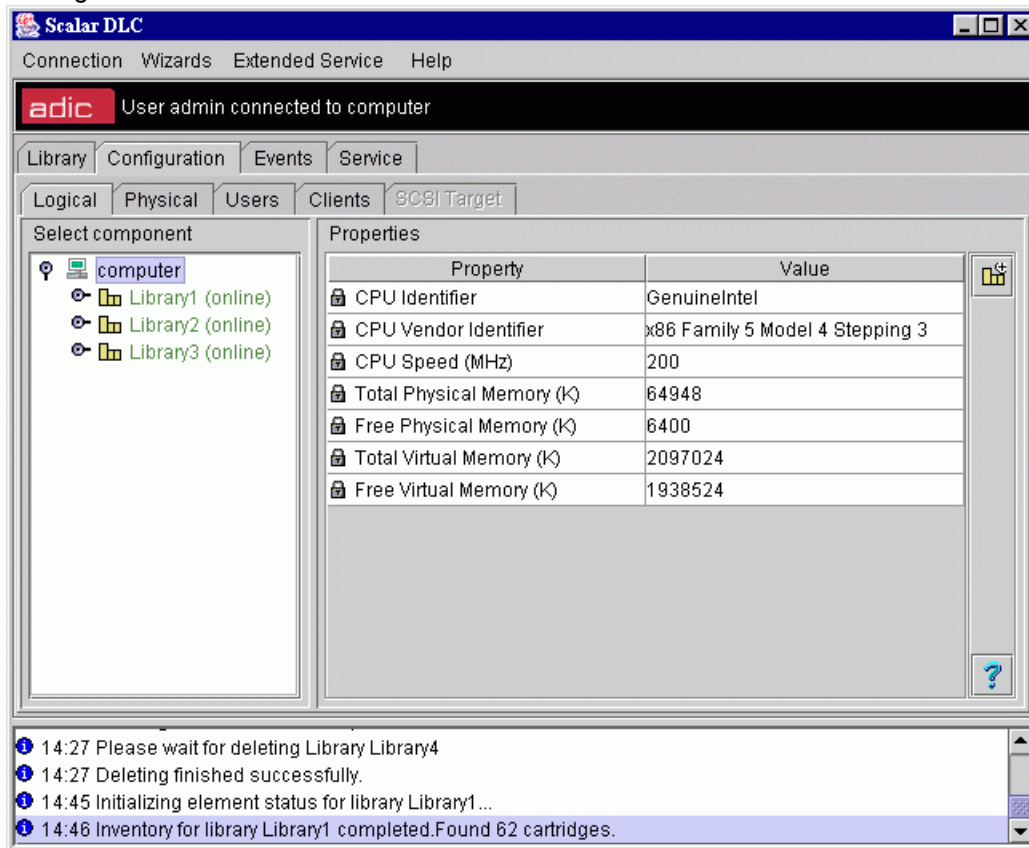

Selecting the Controller causes the Scalar DLC host PC property list to appear.

Field/Button	Icon	Operation	Description
CPU Identifier		Supplied	The CPU identifier
CPU Vendor ID		Supplied	The CPU vendor identifier
CPU Speed		Supplied	The CPU speed
Total Physical Memory		Supplied	The total physical memory size
Free Physical Memory		Supplied	The free physical memory size
Total Virtual Memory		Supplied	The total virtual memory size
Free Virtual Memory		Supplied	The free virtual memory size
Add new Logical Library		Click	The pop-up window of logical library creation appears. Refer to Create Library on page 107.
Help		Click	Open online help for the current pane.

Library

There are three sets of properties associated with the Logical Library. The properties are indicated in the following list:

- Properties. Main library properties. Refer to [Properties](#) on page 89.
- Resource. The resources of physical library that current logical library has in use. Refer to [Resource](#) on page 91.
- Statistics. The statistics of operations executed within current logical library. Refer to [Statistics](#) on page 92







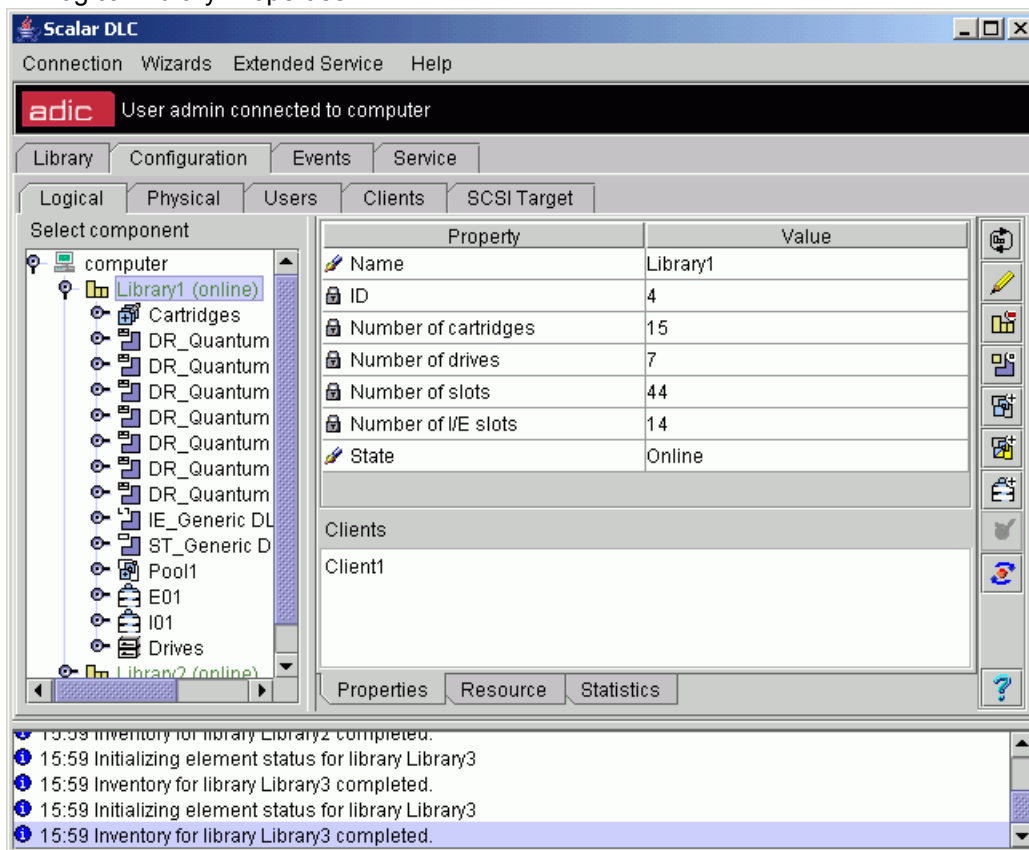





Properties

In the *Select Components* area of the pane, selectable Logical Libraries appear. Clicking the expand/collapse button results in an element expansion.

Figure 61 Logical Library Properties





Field/Button	Icon	Operation	Description
Name		Enter	Logical library name (editable). Also refer to Table 6 on page 16.
ID		Supplied	Logical library identification number.
Number of cartridges		Supplied	Number of available cartridges found during the last inventory .
Number of drives		Supplied	Number of available drives.

Field/Button	Icon	Operation	Description
Number of slots		Supplied	Number of available storage slots.
Number of I/E slots		Supplied	Number of available mailbox slots.
State		Select	Logical library state. See Table 10 on page 63. Can be changed manually (from <i>online</i> to <i>not ready</i> and vice versa) to make the library unavailable but this does not affect the tape device and/or other logical libraries.
Clients		Supplied	The clients authorized to use the logical library.
Inventory		Click	Initialize all the library elements and assign a home position to cartridges. Affects all libraries included the shared partitions.
Update		Click	Save the logical library properties after edit.
Remove		Click	Remove the logical library with all its contents. The shared partitions are not affected.
Assign new Partition		Click	Assign new partition to the logical library. A pop-up assignment window opens. Refer to Assign Partition on page 108. This button is disabled if the physical library contains no partitions that are not assigned to the current logical library.
Add new Scratch pool		Click	Add new scratch pool to the logical library. A pop-up creation window opens. Refer to Create Pool on page 109.
Add new Clean pool		Click	Add new clean pool to the logical library. A pop-up creation window opens. Refer to Create Pool on page 109.
Add new Mailbox		Click	Add new mailbox to the logical library. A pop-up creation window opens. Refer to Create Mailbox on page 110.
Reset Alarm flag		Click	Remove Alarm flag (active only when the library is in <i>Alarm</i> state).
Refresh Alarm flag		Click	Refresh Management GUI for Alarm.
Help		Click	Open online help for the current pane.

Resource

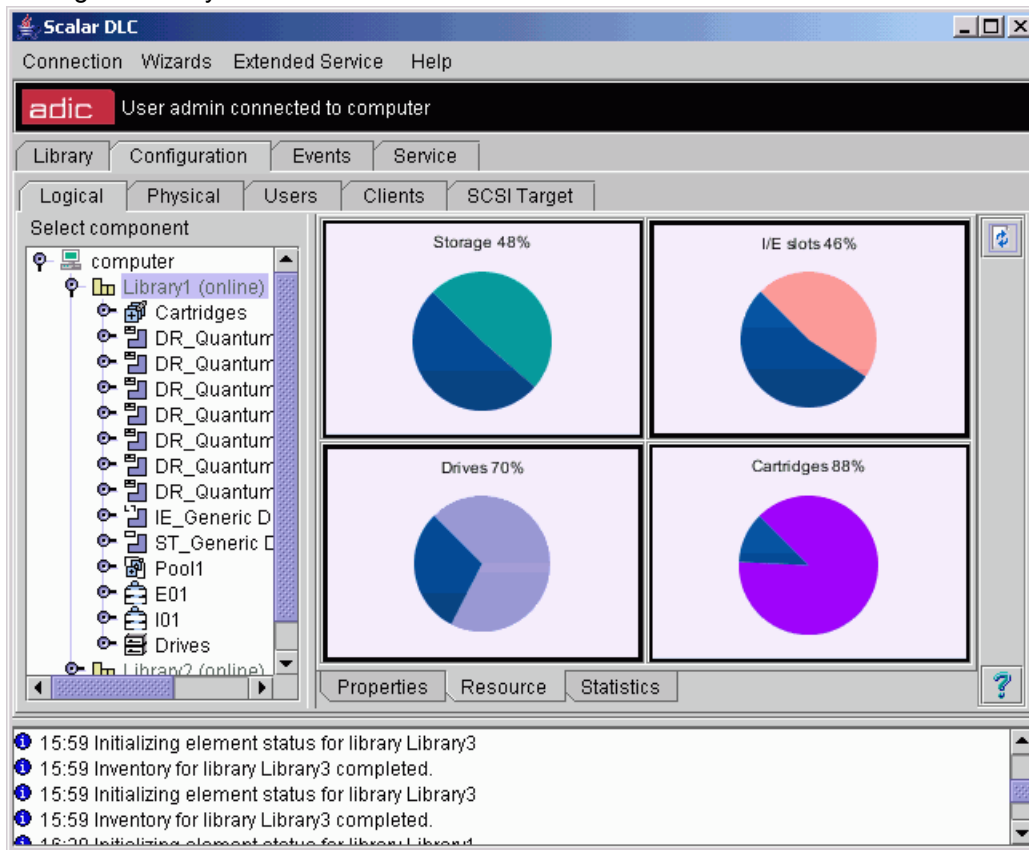
Figure 62 Logical Library Resources





Field/Button	Icon	Operation	Description
Storage		Supplied	Storage slots usage, % and chart.
I/E slots		Supplied	Insert/eject slots usage, % and chart.
Drives		Supplied	Drives usage, % and chart.
Cartridges		Supplied	Cartridges usage, % and chart.
Refresh		Click	Refresh Logical Library resources.
Help		Click	Open online help for the current pane.

The resource charts show the total coverage of the logical library. For example, if the physical library contains 1000 storage slots, and the configured logical library covers 800 slots, the Storage chart shows 80%. Same for the Mailbox (I/E), Drives, and Cartridges.

Statistics

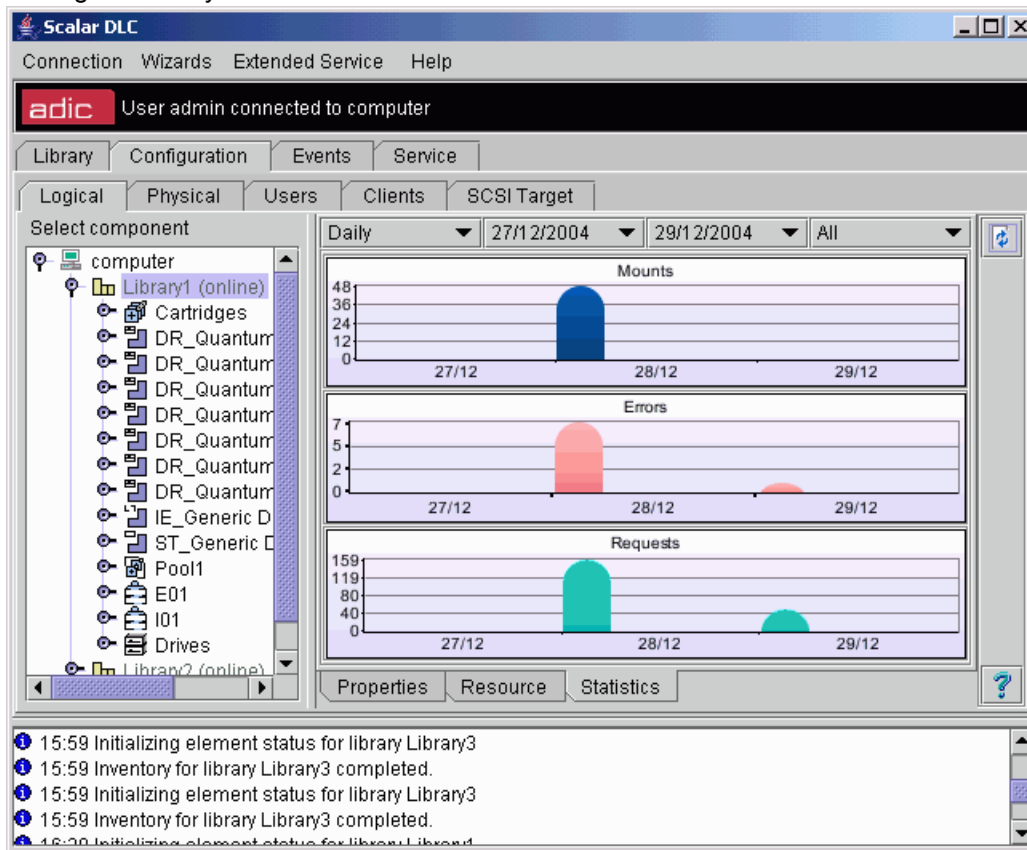
Figure 63 Logical Library Statistics



Field/Button	Icon	Operation	Description
Statistics rate		Select	Show daily/weekly statistics.
Start date		Select	Start date in range.
End date		Select	End date in range.
Statistics type		Select	Statistics type (All / Mounts only / Errors only / Requests only).
Mounts		Supplied	Mounts executed in logical library.
Errors		Supplied	Errors encountered in logical library.
Requests		Supplied	Requests received by logical library.
Refresh		Click	Refresh Logical Library statistics.
Help		Click	Open online help for the current pane.

Select the statistic rate, the date range, and the statistics type, and click on **Refresh** button to show the statistic for the current logical library. By default, all statistics in daily range will be shown from the install date up to current day.

Partition

In the *Select Components* area of the pane, selectable Partitions appear. Clicking the expand/collapse button results in an element expansion.

[Table 13](#) on page 65 shows the different partition classes.

Figure 64 Logical Partition

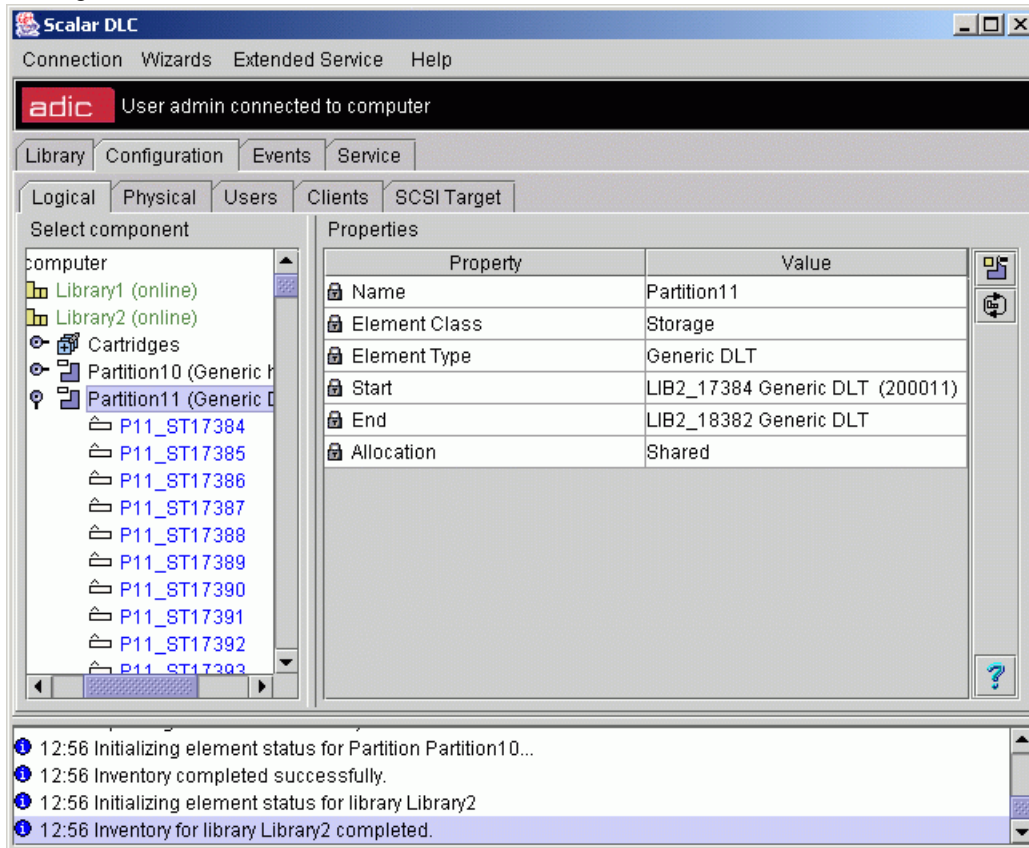

Field/Button	Icon	Operation	Description
Name		Supplied	Partition name.
Element class		Supplied	Partition class (storage, I/E, drive). See Table 13 on page 65.
Element type		Supplied	Partition element type.
Start		Supplied	Start element of partition range.
End		Supplied	End element of partition range.
Allocation		Supplied	<i>Robot1 / Robot2</i> indicates the robotic device where the partition is located. <i>Shared</i> means the partition is shared between two robots.
Unassign partition		Click	Unassign the partition from the logical library (the partition itself remains useful and can be assigned to another logical library).



Field/Button	Icon	Operation	Description
Inventory range		Click	Initialize a range of elements, assign home positions to cartridges if necessary. A pop-up inventory range window appears. See Figure 65 .
Help		Click	Open online help for the current pane.

Figure 65 Inventory Elements Range







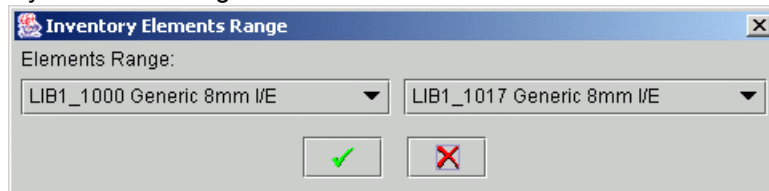



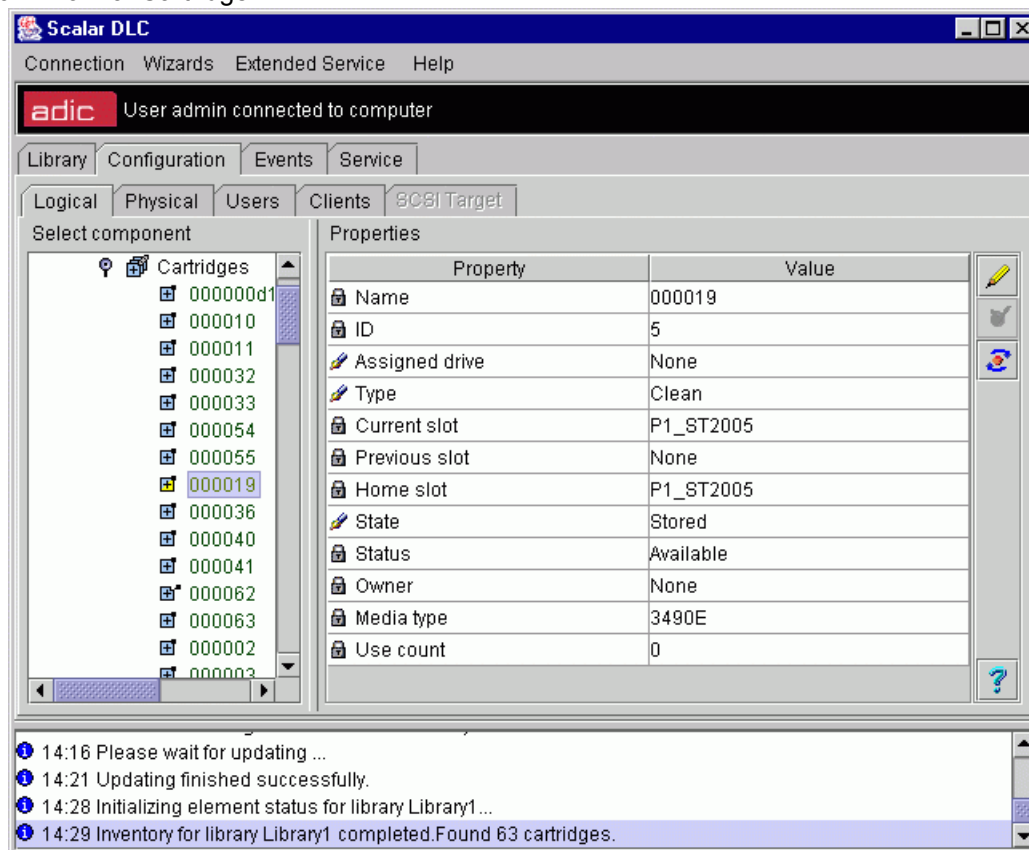











Select start and end elements in the range. Press **OK** to launch the **Inventory Range** operation (it has the same effect as the DAS **PartInventory** command, refer to *DAS Administration Guide*). Press **Cancel** to exit without executing **Inventory Range**.

Cartridge

In the *Select Components* area of the pane, selectable Cartridges appear. Clicking the expand/collapse button results in an element expansion.

Figure 66 Normal Cartridge



Field/Button	Icon	Operation	Description
Name		Supplied	Name (volser), stable for a normal cartridge.
		Enter	Name (volser), editable for a foreign cartridge. Also refer to Table 6 on page 16.
ID		Supplied	Cartridge identification number.
Assigned drive		Select	A drive assigned to cartridge, if any. If the Generic mount operation is executed, the cartridge loads into the assigned drive if it is available.
Type		Select	Cartridge type (data/clean)
Current slot		Supplied	The slot where the cartridge is right now.
Previous slot		Supplied	The slot where the cartridge was previously.
Home slot		Supplied	The cartridge home position. Refer to Home Position on page 79.
State		Select	Cartridge state. See Table 19 on page 78 for the details.
Status		Supplied	The cartridge availability for the commands.
Owner		Supplied	The cartridge owner (client), if any.
Media type		Supplied	Media type, stable for a normal cartridge. Refer to Media Types on page 246.
		Select	Media type, changeable for a foreign cartridge. Refer to Media Types on page 246.
Use count		Supplied	Number of mounts performed (for the data cartridge only).
Number of cleanings done		Supplied	Number of cleanings performed (for the cleaning cartridge only).
Update		Click	Save the cartridge properties after edit.
Reset Alarm flag		Click	Remove Alarm flag (active only when the cartridge is in <i>Alarm</i> state).
Refresh Alarm flag		Click	Refresh Management GUI for Alarm.
Help		Click	Open online help for the current pane.

If the cartridge is not found in the library after the **Inventory** has been executed, its state changes to *offline*. After that, the cartridge is removed from the cartridge list of the Logical library and goes to archive list, or the list of the offline cartridges. It is shown under the Physical tab and contains the information about cartridges that were removed from the physical library. Refer to [Offline Cartridge](#) on page 121.



CAUTION

The only method available from the Management GUI to correctly identify the cleaning cartridges after Inventory has been completed is to manually change the desired individual cartridge type from data to cleaning. Then, if necessary, the acquired cleaning cartridges can be added into the clean pool.

There is also a *foreign cartridges* category (see [Figure 67](#)). These cartridges are either duplicates (another cartridge with the same name exists in the library), or not readable (the barcode scanner that reads the volsers cannot scan the name of current cartridge).

To operate with the foreign cartridges, their properties have been extended: Admin can change the cartridge name (volser) and media type. The foreign cartridge has a media type that is the default for the slot where it is found after the first **Inventory**. The foreign cartridge has a name with a small “u” (for not readable volser), or with a small “d” (for duplicated volser).



Note

The foreign cartridge media type is changeable in the ranges of media domain only. That means the foreign cartridge recognized by default as DLT IV can be changed, for example, to SDLT or DLT IIIXT, but not to 3590. Refer to [Media Types](#) on page 246.

Figure 67 Foreign Cartridge

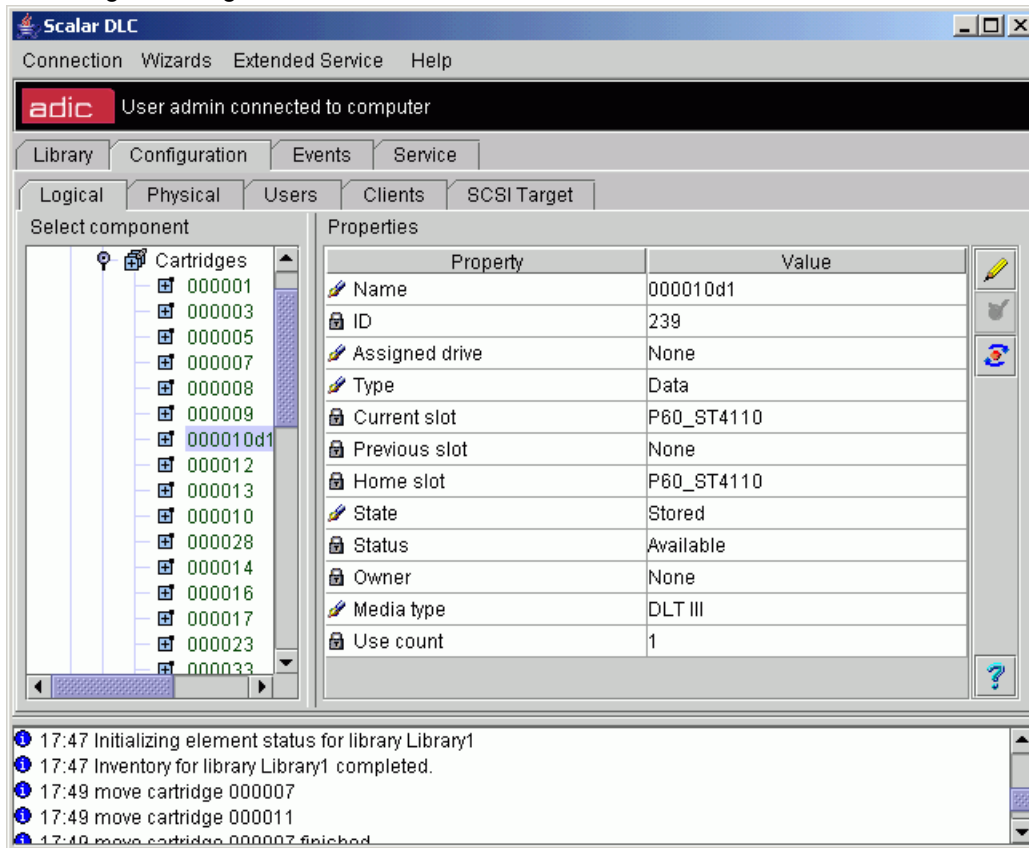





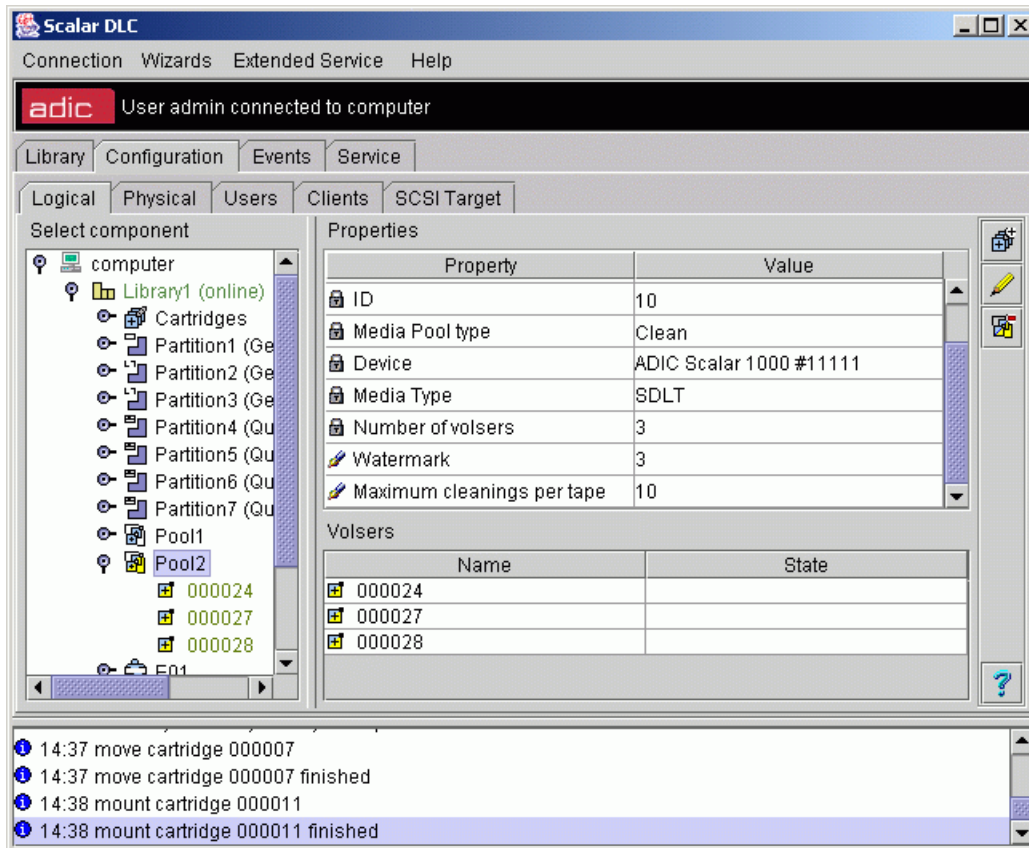

Pool

In the *Select Components* area of the pane, selectable Pools appear. Clicking the expand/collapse button causes an element expansion.

Figure 68 Pool



Field/Button	Icon	Operation	Description
Name		Enter	Pool name. ADIC recommends using Pxx for scratch pools and CLx for clean pools. Also refer to Table 6 on page 16.
ID		Supplied	Pool identification number.
Media Pool type		Supplied	Pool type (data/clean)
Device		Supplied	Name of device (physical library) where the pool is located.
Media Type		Supplied	The type of media contained in the pool. Refer to Media Types on page 246.
Number of volsers		Supplied	The number of cartridges currently contained in the pool.
Watermark		Enter	The minimal number of valid cleaning media the pool should contain. For clean pools only.

Field/Button	Icon	Operation	Description
Maximum cleanings per tape		Enter	The number of times the cleaning cartridge belonging to the pool can be used. For clean pools only.
Volsers		Supplied	The list of cartridges that are currently contained in the pool. The cartridge state is also indicated. Also refer to Cartridge on page 94.
Assign/Unassign		Click	Pop-up Assign/Unassign window opens. Refer to Assign Media to Pool on page 98.
Update		Click	Save the pool properties after edit.
Remove		Click	Remove the scratch pool (the cartridges remains in the library).
			Remove the clean pool (the cartridges remains in the library).
Help		Click	Open online help for the current pane.

 **Note** Pool names are unique for a logical library. Using the default name ensures uniqueness.

Assign Media to Pool

The pop-up window allow assigning cartridges to the existing pool and unassigning the cartridges from it as well.

Figure 69 Assign/Unassign Cartridges to Pool

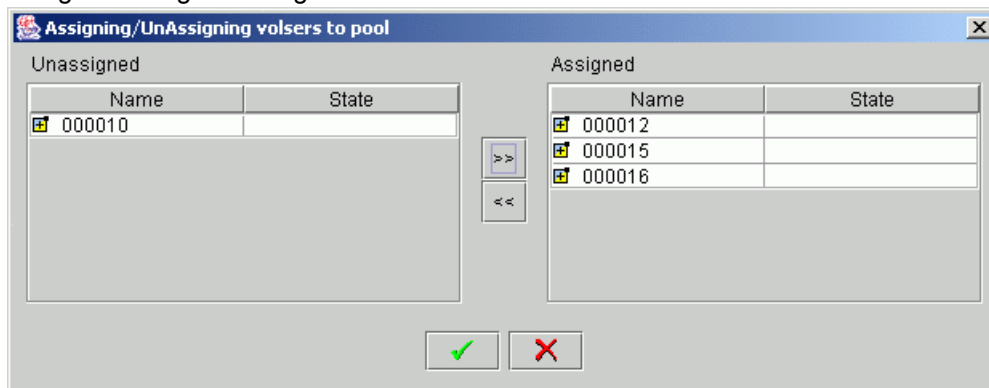

The left pane (*Unassigned*) contains all available media of appropriate type that are not assigned to the pool. The right pane (*Assigned*) contains all cartridges that are already assigned to the pool.

Select a cartridge that should be assigned to the pool (or removed from it) and press the appropriate arrow button (“left” from Assign to Unassign, and “right” vice versa). Multiple cartridge selection is possible, too, by <Ctrl>+Click.

Press **OK** to close the window and update the pool. Press **Cancel** to close the assignment window without applying the changes.



CAUTION

Only the data cartridges can be assigned to the scratch pool; only the cleaning cartridges can be assigned to the clean pool.



Note

The operation of assigning a pack of cartridges to the pool or unassigning a number of cartridges from the pool can be executed as many times as necessary. It is also available from the client side (for DAS clients).



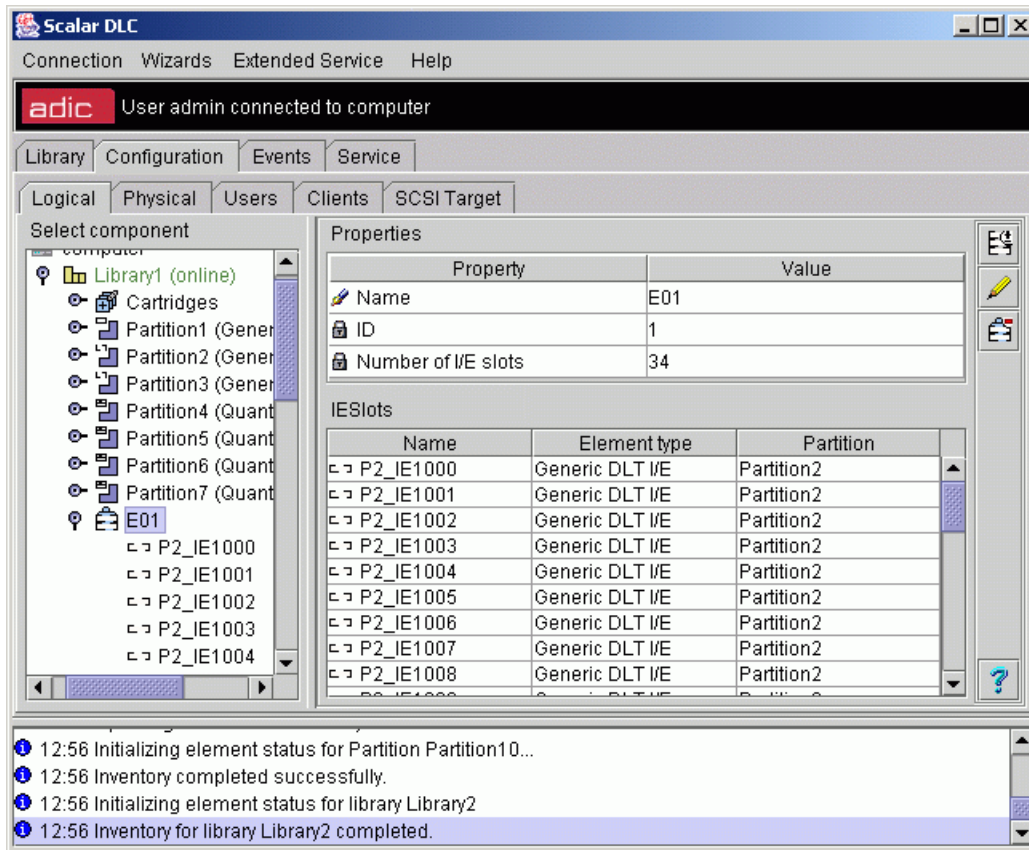

Mailbox

In the *Select Components* area of the pane, selectable Mailboxes appear.

Figure 70 Mailbox



Field/Button	Icon	Operation	Description
Name		Enter	Mailbox name. Also refer to Table 6 on page 16.
ID		Supplied	Mailbox identification number.
Number of I/E slots		Supplied	The number of assigned slots.
I/E slots		Supplied	The slots currently assigned to the mailbox. The slot names, element type, and partition are indicated. Refer also to Mailbox Slot on page 102.

Field/Button	Icon	Operation	Description
Assign/Unassign		Click	Pop-up Assign/Unassign window opens. Refer to Assign Slots to Mailbox on page 100.
Update		Click	Save the mailbox properties after edit.
Remove		Click	Remove the mailbox.
Help		Click	Open online help for the current pane.

 **Note** Mailbox names are unique for a logical library. Using the default name ensures uniqueness.

 **Note** If the DAS interface is used, the mailbox names must adhere to the DAS standards. ADIC recommends “**Exx**” and “**Ixx**” as names for the Export and Import mailboxes respectively (they can consist of the same mailbox slots).

Assign Slots to Mailbox

The pop-up window allow assigning insert/eject slots to the existing mailbox and unassigning the slots from it as well.

Figure 71 Assign/Unassign Slots to Mailbox

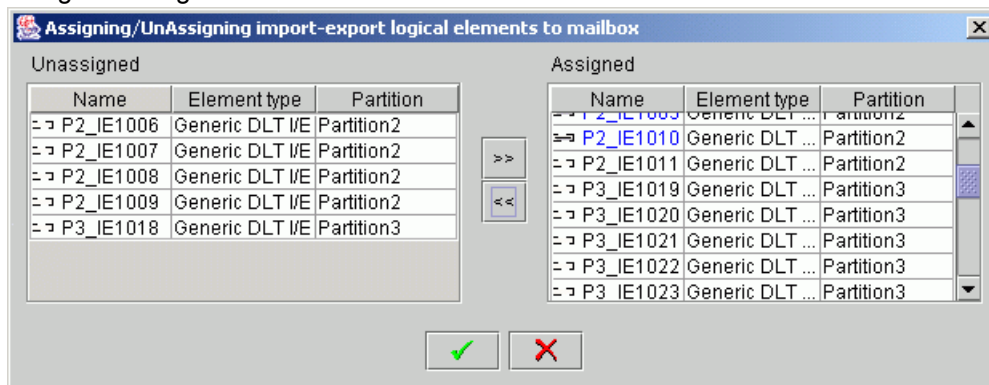

The left pane (*Unassigned*) contains all available insert/eject (mailbox) slots that are not assigned to the current mailbox. The right pane (*Assigned*) contains all mailbox slots that are currently assigned to the mailbox.

Select a slot that should be assigned to the mailbox (or removed from it) and click the appropriate arrow button (“left” from Assign to Unassign, and “right” vice versa). Multiple slot selection is possible, too, by <Ctrl>+Click.

Click **OK** to close the window and update the mailbox. Click **Cancel** to close the assignment window without applying the changes.

 **Note** The operation of assign and unassign a pack of slots to and from the mailbox can be executed as many times as necessary.





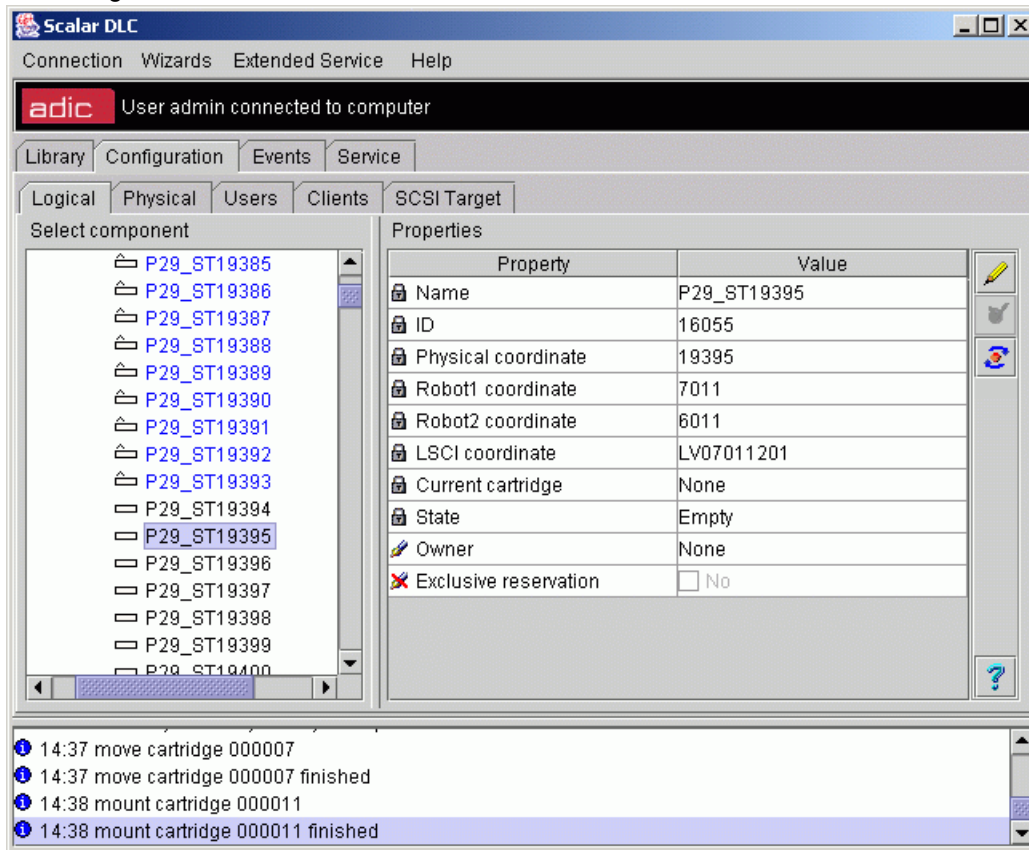

Storage Slot

In the *Select Components* area of the pane, selectable Storage Partitions are displayed. Clicking the expand/collapse button results in an expansion that shows the Storage slots.

Figure 72 Storage Slot



Field/Button	Icon	Operation	Description
Name		Supplied	Slot name.
ID		Supplied	Slot identification number.
Physical coordinate		Supplied	Slot physical (SCSI) coordinate. Refer to Element Addressing on page 244.
Robot1 coordinate		Supplied	The slot coordinate in Robot1 (<i>None</i> means the slot is assigned to another robot). Refer to Element Addressing on page 244
Robor2 coordinate		Supplied	The slot coordinate in Robot2 (<i>None</i> means the slot is assigned to another robot). Refer to Element Addressing on page 244
LSCI coordinate		Supplied	Slot LCSI coordinate. Refer to Element Addressing on page 244.
Current cartridge		Supplied	A contained cartridge, if any.
State		Supplied	Slot state (empty/occupied)









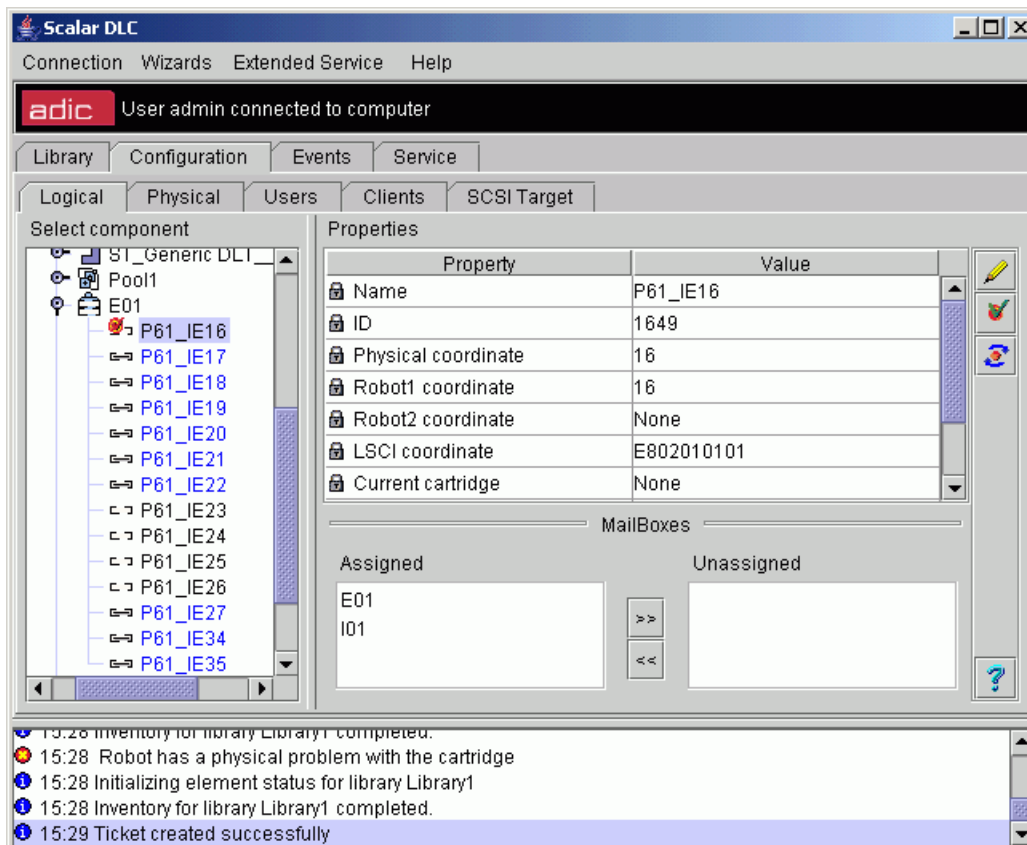





Field/Button	Icon	Operation	Description
Owner		Select	A slot owner (client). The reserved slot can be used only by its owner. <i>None</i> means the slot is not reserved.
Exclusive reservation		Supplied	The reservation may be either <u>normal</u> (another owner can un-reserve the slot) or <u>exclusive</u> (only the owner can change the reservation).
Update		Click	Save the slot properties after edit.
Update		Click	Save the cartridge properties after edit.
Reset Alarm flag		Click	Remove Alarm flag (active only when the slot is in <i>Alarm</i> state).
Refresh Alarm flag		Click	Refresh Management GUI for Alarm.
Help		Click	Open online help for the current pane.

Mailbox Slot

In the *Select Components* area of the pane, selectable Mailboxes and Insert/Eject Partitions appear. Clicking the expand/collapse button causes an expansion that shows the Mailbox slots.

Figure 73 Mailbox Slot



Field/Button	Icon	Operation	Description
Name		Supplied	Slot name.
ID		Supplied	Slot identification number.
Physical coordinate		Supplied	Slot physical (SCSI) coordinate. Refer to Element Addressing on page 244.
Robot1 coordinate		Supplied	The slot coordinate in Robot1 (<i>None</i> means the slot is assigned to another robot). Refer to Element Addressing on page 244
Robor2 coordinate		Supplied	The slot coordinate in Robot2 (<i>None</i> means the slot is assigned to another robot). Refer to Element Addressing on page 244
LSCI coordinate		Supplied	Slot LCSI coordinate. Refer to Element Addressing on page 244.
Current cartridge		Supplied	A cartridge contained in the slot, if any.
State		Supplied	Slot state (empty/occupied)
Owner		Select	A slot owner (client). The reserved slot can be used only by its owner. <i>None</i> means the slot is not reserved.
Exclusive reservation		Supplied	The reservation may be either normal (another owner can un-reserve the slot) or exclusive (only the owner can change the reservation).
Assigned/Unassigned Mailboxes		Select and click	Select mailbox and click arrow button to assign/unassign the current slot to/from it.
Update		Click	Save the slot properties after edit.
Reset Alarm flag		Click	Remove Alarm flag (active only when the slot is in <i>Alarm</i> state).
Refresh Alarm flag		Click	Refresh Management GUI for Alarm.
Help		Click	Open online help for the current pane.

Drive

There are two sets of properties associated with the Drive. The properties are indicated in the following list:

- Properties. Main drive properties. Refer to [Properties](#) on page 104.
- Statistics. The statistics of operations executed within current drive. Refer to [Statistics](#) on page 106.







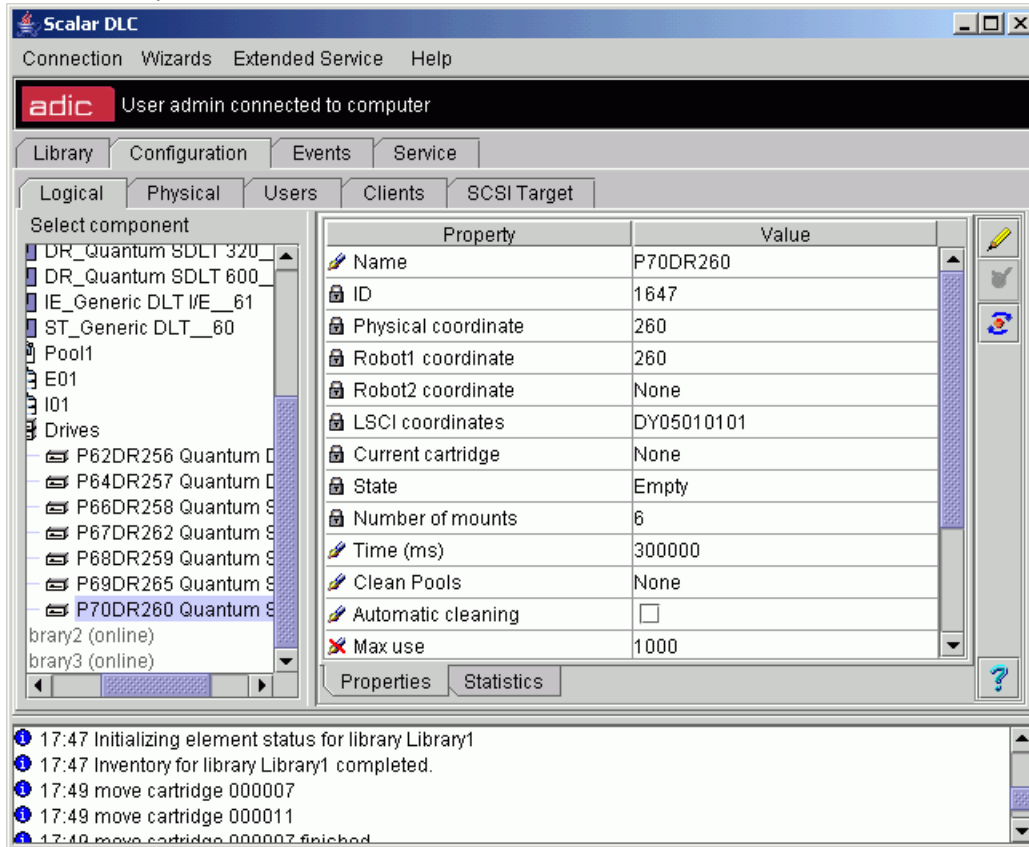











Properties

In the *Select Components* area of the pane, selectable Drives and Drive Partitions are displayed. Clicking the expand/collapse button results in an element expansion.

Figure 74 Drive Properties



Field/Button	Icon	Operation	Description
Name		Enter	Drive name. Also refer to Table 6 on page 16.
ID		Supplied	Drive identification number.
Physical coordinate		Supplied	Drive physical (SCSI) coordinate. Refer to Element Addressing on page 244.
Robot1 coordinate		Supplied	The drive coordinate in Robot1 (<i>None</i> means the slot is assigned to another robot). Refer to Element Addressing on page 244

Field/Button	Icon	Operation	Description
Robot2 coordinate		Supplied	The drive coordinate in Robot2 (<i>None</i> means the slot is assigned to another robot). Refer to Element Addressing on page 244
LSCI coordinate		Supplied	Drive LCSI coordinate. Refer to Element Addressing on page 244.
Current cartridge		Supplied	A cartridge contained in the slot, if any.
State		Supplied	Drive state (empty/occupied).
Number of mounts		Supplied	A total number of mounts executed into the drive.
Time (ms)		Enter	The cleaning time for the drive.
Clean pool		Select	A pool that is used by clean manager to get the cleaning cartridges.
Automatic cleaning		Check	Configure auto-cleaning. If checked, the <i>Max Use</i> field is editable.
Max Use		Supplied	Shows how long the drive could be used without cleaning (number of mounts between cleanings).
Dismount management		Check	Configure the dismount manager. If checked, the <i>Delay</i> and <i>Loops</i> fields are editable.
Delay (ms)		Supplied	A time the drive requires to unload the cartridge.
Loops		Supplied	Number of retries if the drive does not unload the cartridge.
Owner		Select	A slot owner (client). The reserved slot can be used only by its owner. <i>None</i> means the slot is not reserved.
Exclusive reservation		Supplied	The reservation may be either normal (another owner can un-reserve the slot) or exclusive (only the owner can change the reservation).
Update		Click	Save the slot properties after edit.
Reset Alarm flag		Click	Remove Alarm flag (active only when the slot is in <i>Alarm</i> state).
Refresh Alarm flag		Click	Refresh Management GUI for Alarm.
Help		Click	Open online help for the current pane.



 **Note**

If the DAS interface is being used, the drives are to be named according to the DAS standards. ADIC recommends using names no more than 9 alphanumeric characters long and beginning with a letter.

Statistics

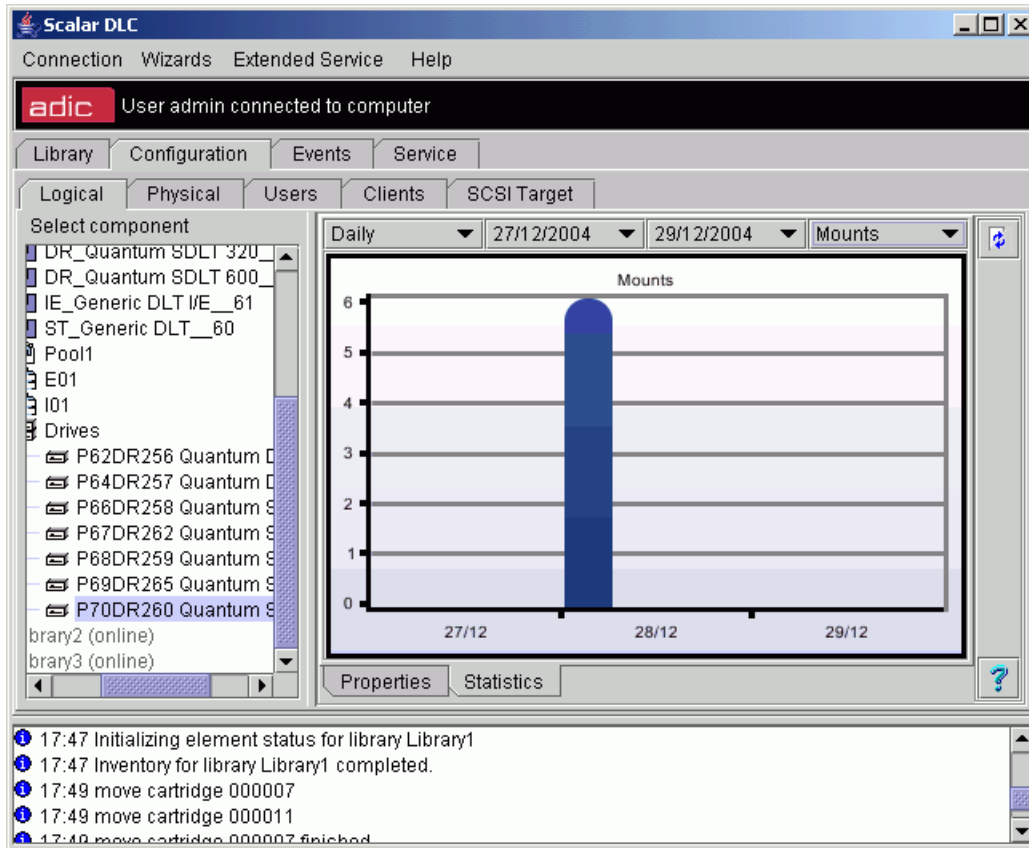
Figure 75 Drive Statistics



Field/Button	Icon	Operation	Description
Statistics rate		Select	Show daily/weekly statistics.
Start date		Select	Start date in range.
End date		Select	End date in range.
Statistics type		Select	Statistics type (All / Mounts only / Errors only / Cleanings only).
Mounts		Supplied	Mounts executed by the drive.
Errors		Supplied	Errors encountered in the drive.
Cleanings		Supplied	Cleanings done in drive.
Refresh		Click	Refresh Logical Library statistics.
Help		Click	Open online help for the current pane.

Create Library

Under the Controller properties, the **Add new Logical Library** button appears. Clicking it opens a pop-up library creation pane.









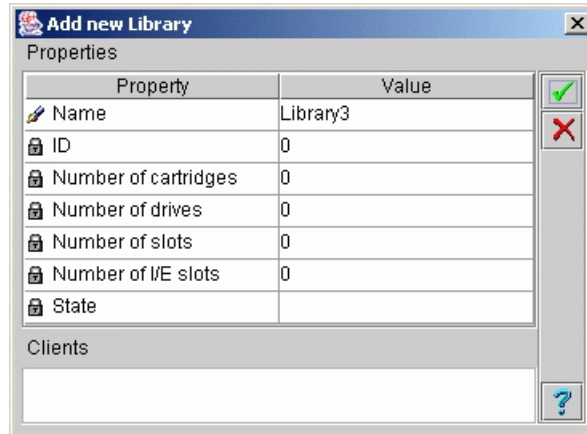

 **Note** Only administrator users can create the library. For the user without administrative privileges, the **Add new Library** button is disabled.

Figure 76 Logical Library Creation



Field/Button	Icon	Operation	Description
Name		Enter	New logical library name. Also refer to Table 6 on page 16.
ID		Supplied	Logical library identification number.
Number of cartridges		Supplied	Number of available cartridges.
Number of drives		Supplied	Number of available drives.
Number of slots		Supplied	Number of available storage slots.
Number of I/E slots		Supplied	Number of available mailbox slots.
State		Supplied	Logical library state. See Table 10 on page 63.
Clients		Supplied	The clients attached to the logical library. Always empty for the library that is being created.
Create		Click	Create logical library.
Cancel		Click	Cancel creation.
Help		Click	Open online help for the current pane.



CAUTION

The created logical library is *invalid* and not operable. To complete the library configuration, at least two partitions (storage and drive, three recommended — storage, insert/eject, and drive) should be assigned to the logical library before the inventory can be executed. Refer to [Assign Partition](#) on page 108 and [Assign Partitions](#) on page 38.

Assign Partition

Under the Library properties, the **Assign Partition** button appears. Clicking it opens a pop-up partition assignment pane.



Note

Only administrator users can assign the partitions. For the user without administrative privileges, the **Assign Partition** button is disabled.





Note

There is a more powerful engine for the multiple partition assignment operation. It is accessible from the Main Menu bar. Refer to [Assign Partitions](#) on page 38.

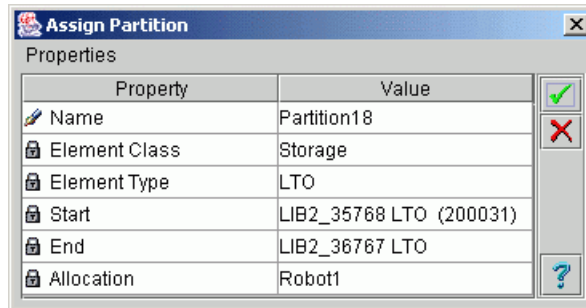
Figure 77 Partition Assign



Field/Button	Icon	Operation	Description
Name		Select	Select the partition to assign
Element class		Supplied	Partition class (storage, I/E, drive). See Table 13 on page 65.
Element type		Supplied	Partition element type.
Start		Supplied	Start element of partition range.
End		Supplied	End element of partition range.
Allocation		Supplied	<i>Robot1 / Robot2</i> indicates the robotic device where the partition is located. <i>Shared</i> means the partition is shared between two robots.
Assign		Click	Assign partition

Field/Button	Icon	Operation	Description
Cancel		Click	Cancel assignment.
Help		Click	Open online help for the current pane.

Create Pool

Under the Library properties, the **Add new Scratch Pool** and **Add new Clean Pool** buttons appear. Clicking either opens a pop-up pool creation pane.









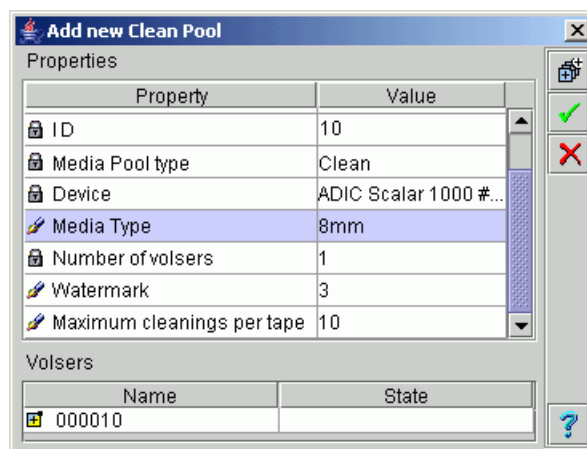





Note

Only administrator users can create the mailboxes. For the user without administrative privileges, both the **Add new Scratch Pool** and **Add new Clean Pool** buttons are disabled.

Figure 78 Pool Creation



Field/Button	Icon	Operation	Description
Name		Enter	Pool name. Also refer to Table 6 on page 16.
ID		Supplied	Pool identification number.
Media Pool type		Supplied	Pool type (data/clean).
Device		Supplied	The name of device (physical library) where the pool is located.
Media type		Select	The type of media contained in the pool. Refer to Media Types on page 246.
Number of volsers		Supplied	The number of cartridges currently contained in the pool.
Watermark		Enter	The minimal number of valid cleaning media the pool should contain. For clean pools only.

Field/Button	Icon	Operation	Description
Maximum cleanings per tape		Enter	The number of times the cleaning cartridge belonging to the pool can be used. For clean pools only.
Volsers		Supplied	The list of cartridges that are currently contained in the pool. The cartridge state is also indicated. Also refer to Cartridge on page 94.
Assign/Unassign		Click	Pop-up Assign/Unassign cartridges dialog opens. Refer to Assign Media to Pool on page 98.
Create		Click	Create pool.
Cancel		Click	Cancel creation.
Help		Click	Open online help for the current pane.

 **Note** Pool names are unique for a logical library. Using the default name ensures uniqueness.

Create Mailbox

Under the Library properties, the **Add new Mailbox** button appears. Clicking it opens a pop-up mailbox creation pane.







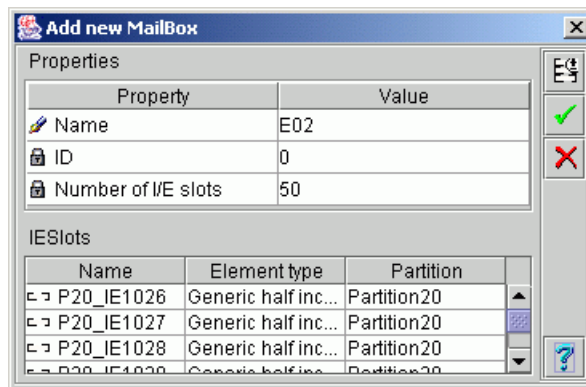

 **Note** Only administrator users can create the mailboxes. For the user without administrative privileges, the **Add new Mailbox** button is disabled.

Figure 79 Mailbox Creation



Field/Button	Icon	Operation	Description
Name		Enter	Mailbox name. Also refer to Table 6 on page 16.
ID		Supplied	Mailbox identification number.

Field/Button	Icon	Operation	Description
Number of I/E slots		Supplied	The number of assigned slots.
I/E slots		Supplied	The list of slots that are currently assigned to the mailbox. The slot names, element type, and partition are indicated.
Assign/Unassign		Click	Pop-up Assign/Unassign mailbox slots dialog opens. Refer to Assign Media to Pool on page 98.
Create		Click	Create mailbox.
Cancel		Click	Cancel creation.
Help		Click	Open online help for the current pane.



Note

Mailbox names are unique for a logical library. Using a default name ensures uniqueness.

Physical Tab

The Physical Tab pane describes the configuration of a physical library. The starting Physical pane shows the Scan SCSI properties of the Scalar DLC host PC.







 **Note** Only administrator users can modify the Scalar DLC system configuration. For the user without administrative privileges the operation buttons remain disabled.

Figure 80 Physical Controller

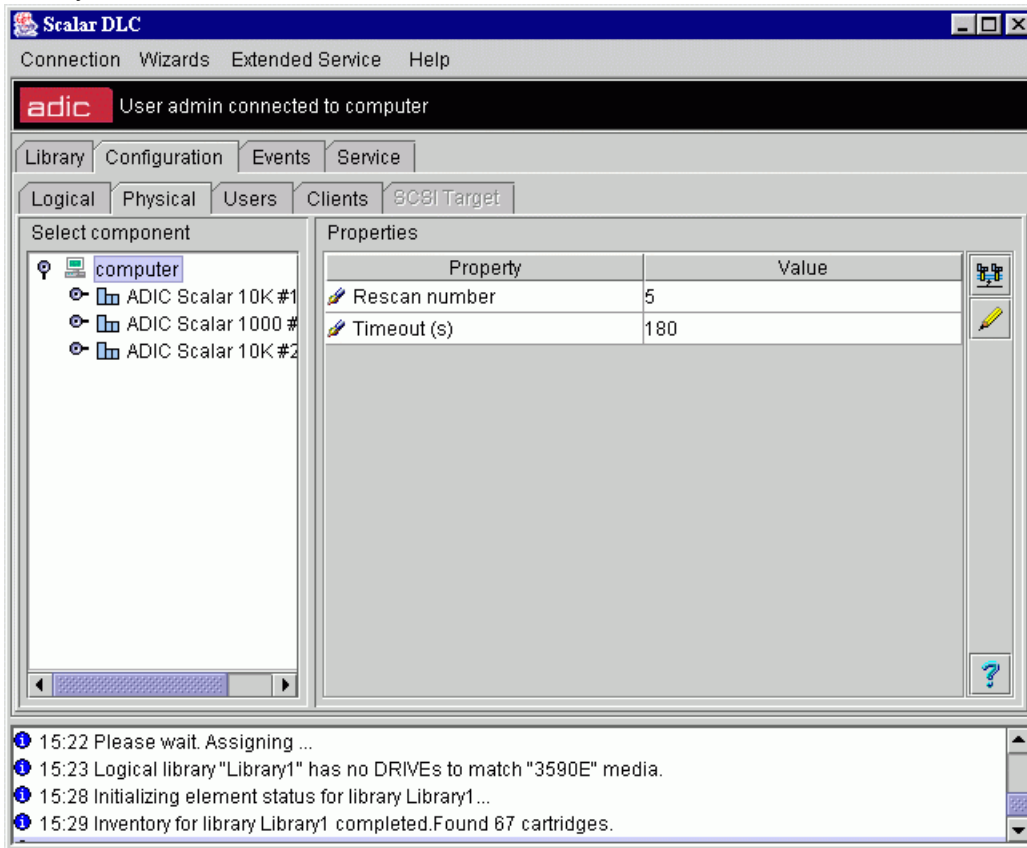

Field/Button	Icon	Operation	Description
Rescan number		Enter	The number of Rescan SCSI Bus operations done.
Timeout(s)		Enter	The default timeout time, ms.
Scan SCSI Bus		Click	Scan SCSI bus and create the physical library objects for each new library found.
Update		Click	Save properties after edit.
Help		Click	Open online help for the current pane.

Library

In the *Select Components* area of the pane, selectable Physical Libraries appear. Clicking the expand/collapse button causes an element expansion.

There are three sets of properties associated with a physical library.







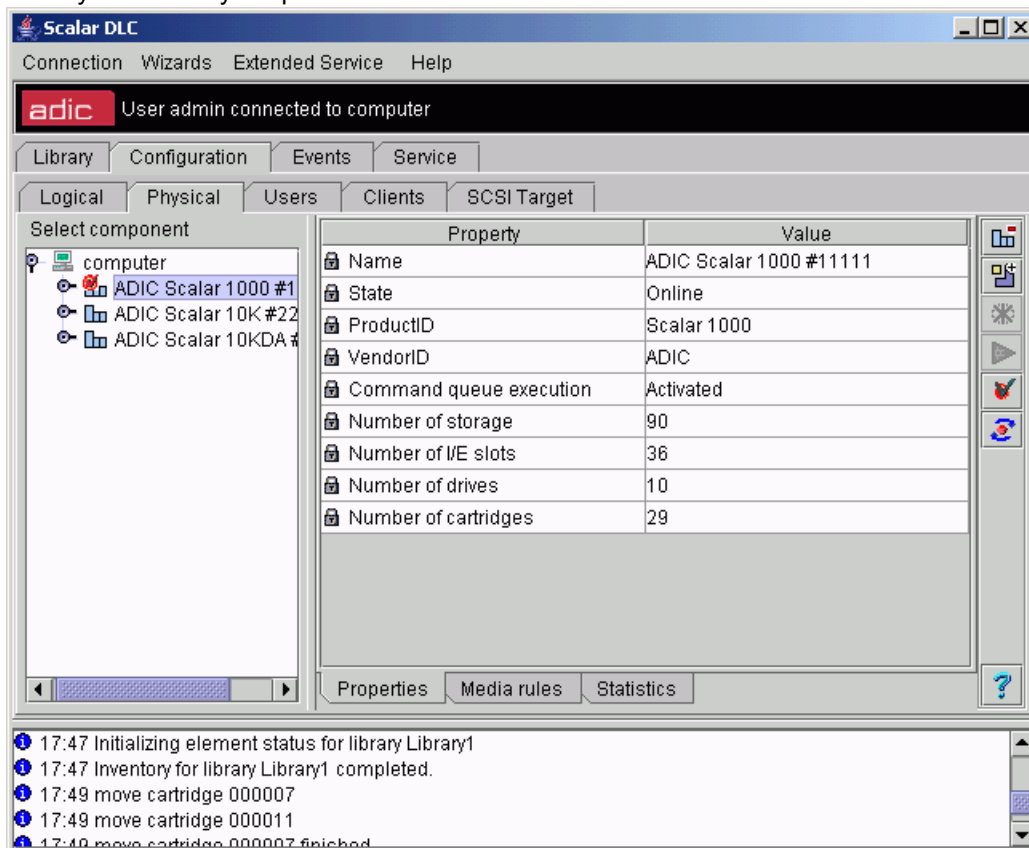





- Properties. The properties of physical library. Refer to [Properties](#) on page 113.
- Media Rules. Setting the media rules for the physical library. Refer to [Media Rules](#) on page 115.
- Statistics. Monitoring the statistics fir the physical library. Refer to [Statistics](#) on page 117.

Properties

Figure 81 Physical Library Properties



Field/Button	Icon	Operation	Description
Name		Supplied	Tape device name.
State		Supplied	Physical library state. See Table 11 on page 64.
Product ID		Supplied	Library product ID.
Vendor ID		Supplied	Library vendor ID.

Field/Button	Icon	Operation	Description
Command queue execution ^a		Supplied	<i>Activated</i> means commands should be executed when they arrive to the physical library. <i>Frozen</i> means commands should be executed only after the library will be activated again.
Number of storage		Supplied	Number of available storage slots.
Number of I/E slots		Supplied	Number of available mailbox slots.
Number of drives		Supplied	Number of available drives.
Number of cartridges		Supplied	Number of available cartridges.
Remove		Click	Remove the physical library.
Add new Partition		Click	Add new partition. Refer to Create Partition on page 127.
Freeze		Click	Freeze command queue execution.
Activate		Click	Activate command queue execution (after freeze).
Reset Alarm flag		Click	Remove Alarm flag (active only when the library is in <i>Alarm</i> state).
Refresh Alarm flag		Click	Refresh Management GUI for Alarm.
Help		Click	Open online help for the current pane.

a. The Freeze command queue execution feature currently is implemented for the Scalar 10K DA libraries only.



CAUTION

If the physical library properties are changed (for example, another drive added), the Scan SCSI Bus operation does not update the existing library properties. The update can be done only by the Teach command from the device operator panel.



CAUTION

When new drive(s) and/or insert/eject slot(s) have been added to the physical library that already contains a working configuration (logical library, clients, etc.), the admin must check whether the configuration of partitions is still correct. Refer to [Partition](#) on page 119.

The operation of assign-unassign partitions may be required. Refer to [Assign Partition](#) on page 108 and [Assign Partitions](#) on page 38.



CAUTION

If the physical library is removed, all partitions, media rules, and offline cartridges are lost. Library delete confirmation is required.

Media Rules

The physical library cannot always correctly identify the cartridge media type by recognizing its barcode label (especially for the old models of barcode readers). The media domain is always recognized correctly, the media type is not. In such cases the un-recognized volser receives the media type as default to the slot where it has been found during **Inventory**.

However, this may lead to incorrect assignment of media type to cartridge, and that can even lead to a hardware crash (for example, if the SDLT cartridge has been mis-identified as DLT III and mounted to the Quantum DLT 4000 drive).

To improve the situation, a Media rules feature has been provided so the Scalar DLC administrator can assign a correct media type to the range of volsers. The typical rule is, "if the cartridge is in the specified volser range and has the specified media domain, check whether it has the specified media type". The volser ranges specified in different rules cannot overlap by media domain (that means, two rules cannot have both same media domain and overlapped volser ranges). See [Figure 82](#) on page 115.

Also refer to [Media Types](#) on page 246 and [Drive Types](#) on page 249.

 **Note** The media rules do not work automatically and require the manual appliance and confirmation.





 **CAUTION** The media rules feature should be used only by very experienced users. The incorrect assignment of media type to cartridge can cause a hardware crash.

Figure 82 Media Rules

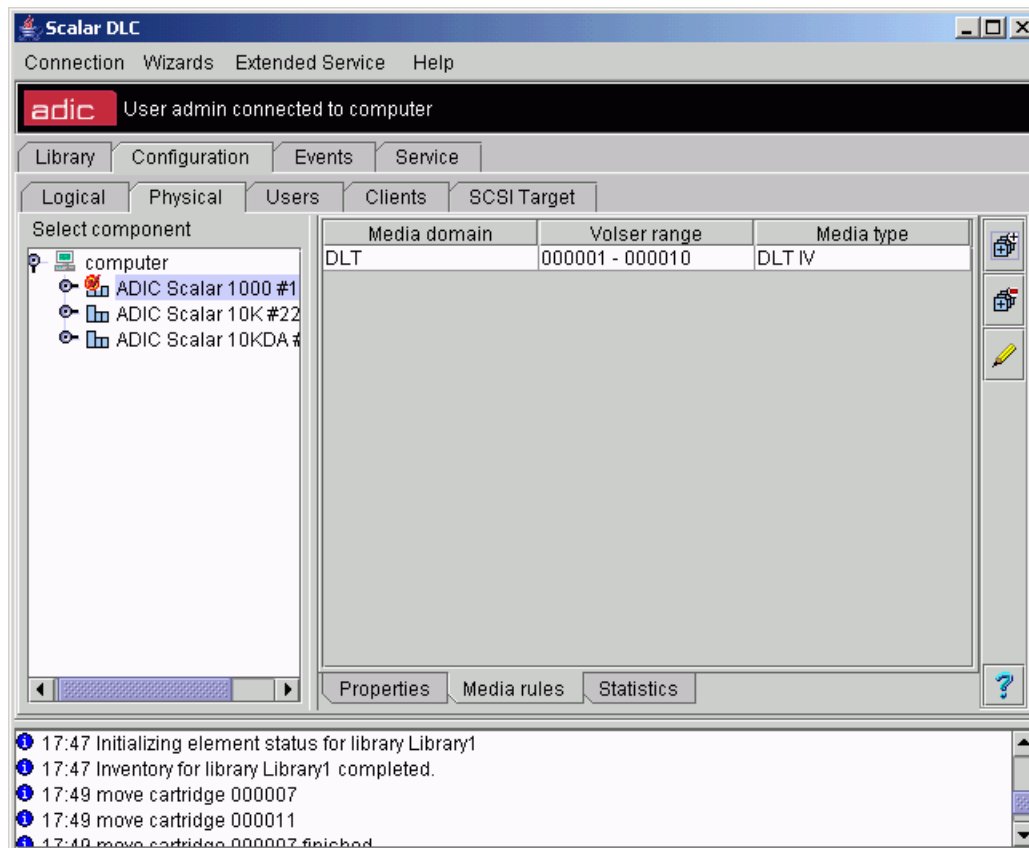

Field/Button	Icon	Operation	Description
Media domain		Supplied	The domain of media selected by the rule.
Volser Range		Supplied	The range of volsers selected by the rule.
Media type		Supplied	The media type that should be assigned.
Add		Click	Add a new media rule. A pop-up window opens, refer to Create Media Rule on page 116.
Remove		Click	Remove an existing rule.
Apply		Click	Apply the selected rule. A pop-up window opens, refer to Apply Media Rule on page 116.
Help		Click	Open online help for the current pane.

Create Media Rule

The pop-up pane allows to create media rule.

 **Note** Only administrator users can create the media rules. For the user without administrative privileges the button is disabled.

Figure 83 Media Rule Creation



Enter the volser range. Select the media domain. Specify the media type that should be assigned to the cartridges in the specified range, if they do have an appropriate media domain. Click **OK** to create and apply the media rule. Click **Cancel** to exit without creating the media rule.

Apply Media Rule

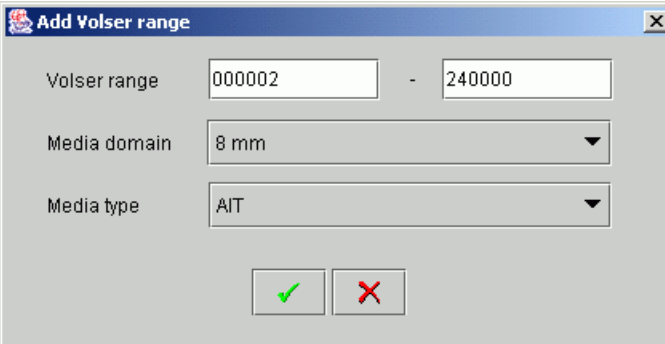
The pop-up pane allows to apply the existing media rule.

 **Note** Only administrator users can apply the media rules. For the user without administrative privileges the button is disabled.

Figure 84 Apply Media Rule

Volser	Old media type	New media type	Use
000042	8mm	AIT	<input checked="" type="checkbox"/>
2221u1	8mm	AIT	<input checked="" type="checkbox"/>
2222u2	8mm	AIT	<input checked="" type="checkbox"/>
2223u3	8mm	AIT	<input checked="" type="checkbox"/>



For every *Volser*, check whether the *New* media type should be used instead of *Old* media type. Leave *Use* check box blank if it is not true. Click **OK** to apply the media rule. Press **Cancel** to close the pane without applying the rule.

Statistics

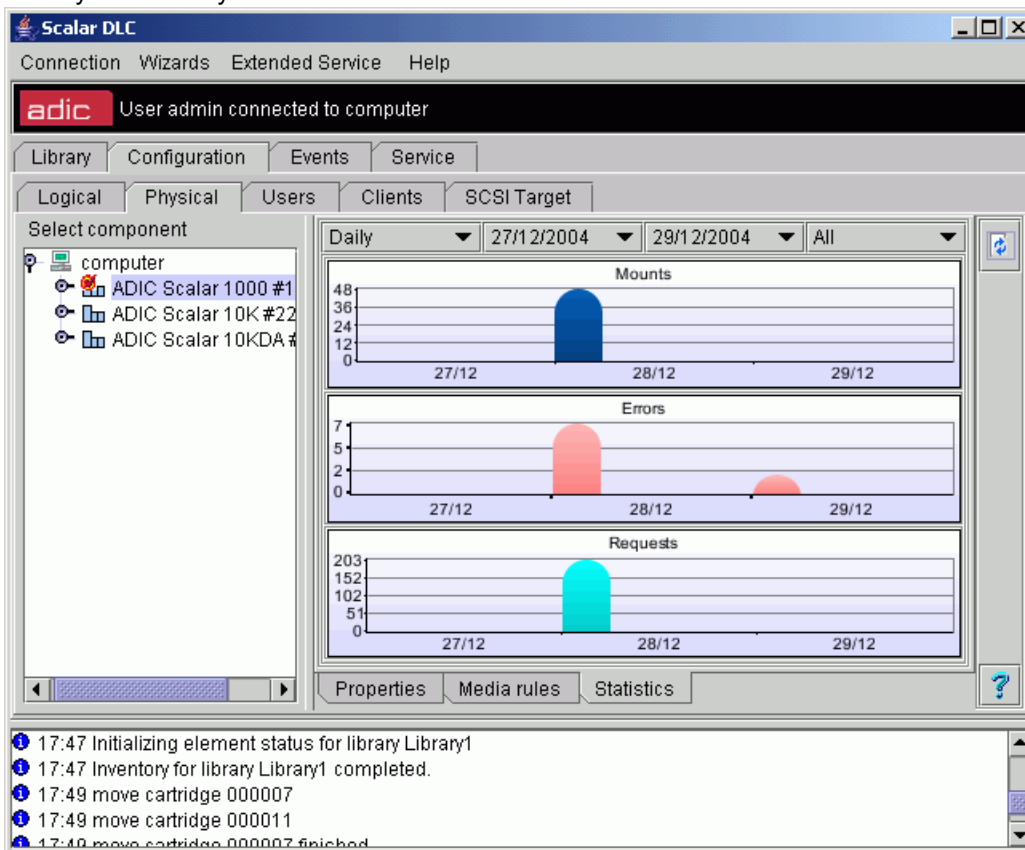
Figure 85 Physical Library Statistics



Field/Button	Icon	Operation	Description
Statistics rate	Select	Select	Show daily/weekly statistics.
Start date	Select	Select	Start date in range.
End date	Select	Select	End date in range.
Statistics type	Select	Select	Statistics type (All / Mounts only / Errors only / Requests only).
Mounts	Supplied	Supplied	Mounts executed in physical library.
Errors	Supplied	Supplied	Errors encountered in physical library.





Field/Button	Icon	Operation	Description
Requests		Supplied	Requests received by physical library.
Refresh		Click	Refresh Physical Library statistics.
Help		Click	Open online help for the current pane.

Robot

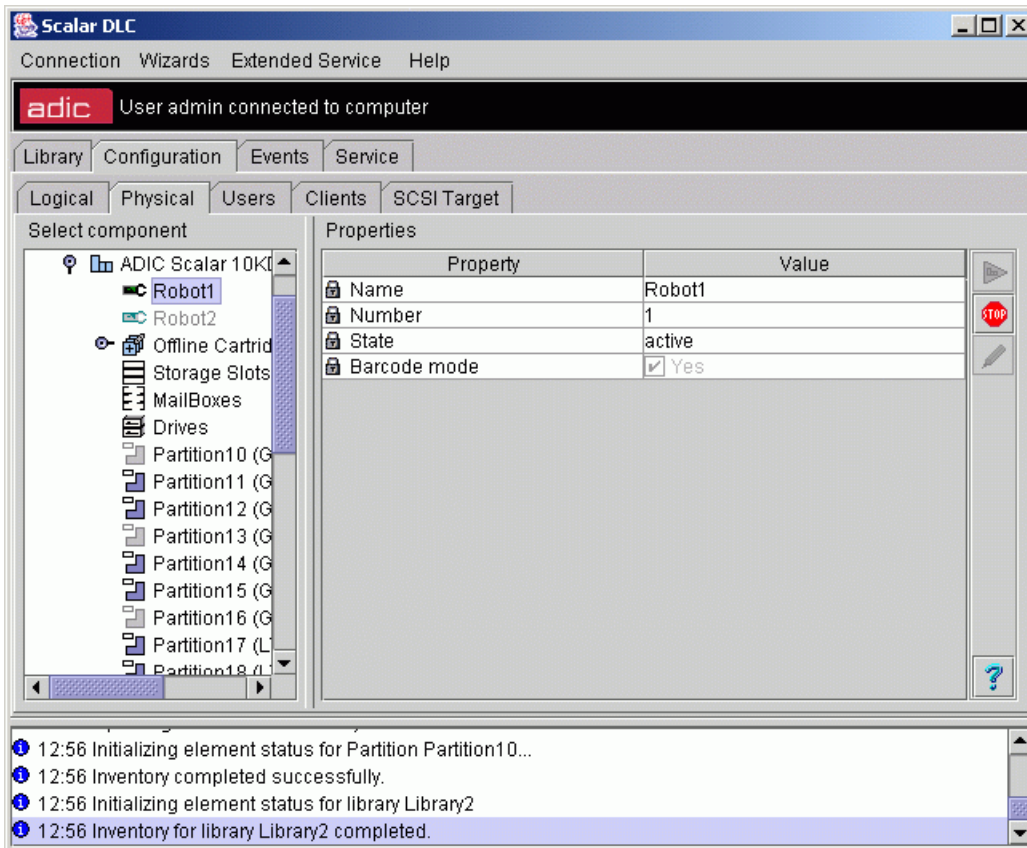
Depending on type, the physical library can have either one robotic controller (single-aisle library - Scalar 1000, Scalar 10K), or two (dual-aisle library, Scalar 10K DA).

Figure 86 Robot Online



Field/Button	Icon	Operation	Description
Name		Supplied	Robotic controller name.
Number		Supplied	Robotic controller number (1 for single-aisle robot, 1 or 2 for dual-aisle robots).
State		Supplied	Robotic controller state. See Table 12 on page 64.
Barcode mode		Supplied	Barcode reader is always active for the Scalar robots.
Start		Click	Start the robot that is currently <i>offline</i> .



Field/Button	Icon	Operation	Description
Stop		Click	Stop the robot that is currently <i>online</i> .
Update		Click	Update the robot parameters after edit.
Help		Click	Open online help for the current pane.

Figure 87 Robot Offline



Partition

Partition is a segment of the physical library that contains a continuous range of slots of single class (for example, Storage) and type (for example, DLT). The partitions cannot overlap, so if the admin wants to create a partition that includes a part of an occupied range, it is required to remove the previous partition and create two new partitions instead.

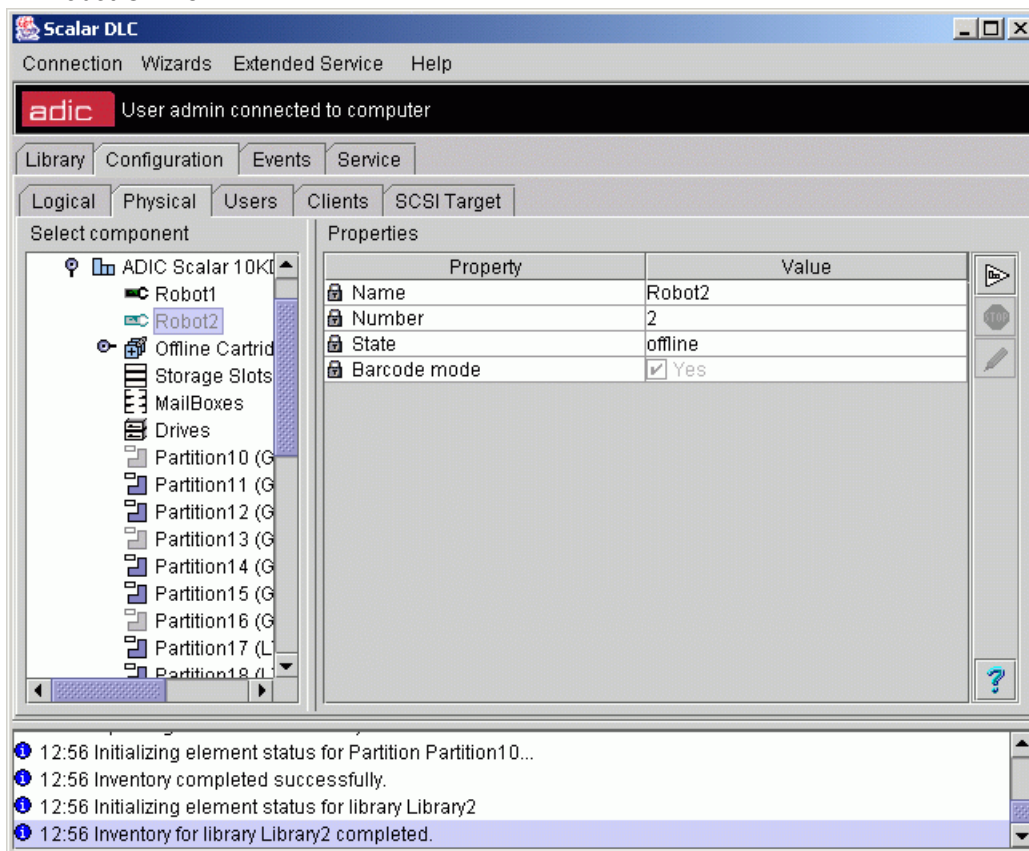
[Table 13](#) on page 65 shows the different partition classes.





Note

Only administrator users can modify or remove the partition. For the user without administrative privileges, the operation buttons remain disabled.

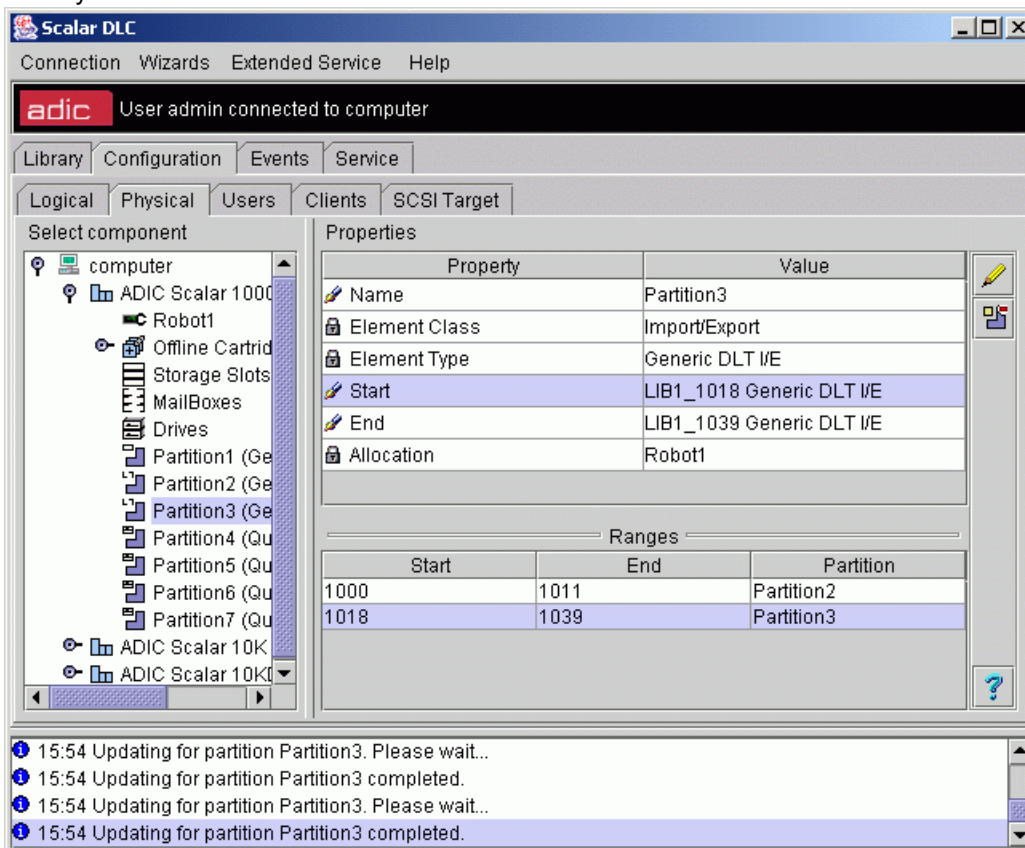
Figure 88 Physical Partition



Field/Button	Icon	Operation	Description
Name		Enter	Partition name. Should be unique throughout all physical libraries. Also refer to Table 6 on page 16.
Element class		Supplied	Partition class (storage, I/E, drive). See Table 13 on page 65.
Element type		Supplied	Partition element type. Refer to Storage Types on page 247, Mailbox Types on page 248, or Drive Types on page 249.
Start		Supplied	Start element of partition range.
End		Supplied	End element of partition range.
Allocation		Supplied	<i>Robot1 / Robot2</i> indicates the robotic device where the partition is located. <i>Shared</i> means the partition is shared between two robots.
Ranges		Supplied	The element ranges of selected class and type inside the current physical library. The ranges already occupied with the partitions are shown in gray, and the partition name is indicated. The ranges that are free for the new partition are shown in black.
Update		Click	Save partition properties after edit.

Field/Button	Icon	Operation	Description
Remove		Click	Remove the partition.
Help		Click	Open online help for the current pane.



Note

The shared partitions are always based on tower storages. Non-shared storage partition may be based either on tower, or on linear shelve.

Offline Cartridge

If the cartridge is not found in the library after the **Inventory** has been executed, its state changes to *offline*. After that, the cartridge is removed from the Cartridge list of the Logical library and goes to the archive list, or the list of offline cartridges. It is displayed on the Physical tab and contains the information about cartridges that were removed from the physical library.

The offline cartridge typically contains a short description (for example, when and why it has been removed). The user can physically remove the offline cartridge if this cartridge should not be returned to the system.

The offline cartridges could either save their home position (if they were removed from the library in either *stored*, *ejected*, or *mounted* state), or lose it (if they were removed in *problem box* or *unloaded* state). If the offline cartridge resided in the home position right before it was removed, this coordinate is saved. If the cartridge later returns to the library, the executed **Inventory** restores its old home position. However, when the cartridge is offline, another cartridge may occupy its old home slot because it is not marked as the home position of a valid cartridge. Should that be the case, the user can either move that cartridge to another storage slot to free the home position of the offline cartridge that he wants to return to the library later, or he can simply return the cartridge to the library. If the user prefers the last, an **Inventory** assigns a new valid home position to a cartridge.

In the *Select Components* area of the pane, selectable Offline Cartridges is displayed. Clicking the expand/collapse button results in an element expansion.

Figure 89 Offline Cartridges

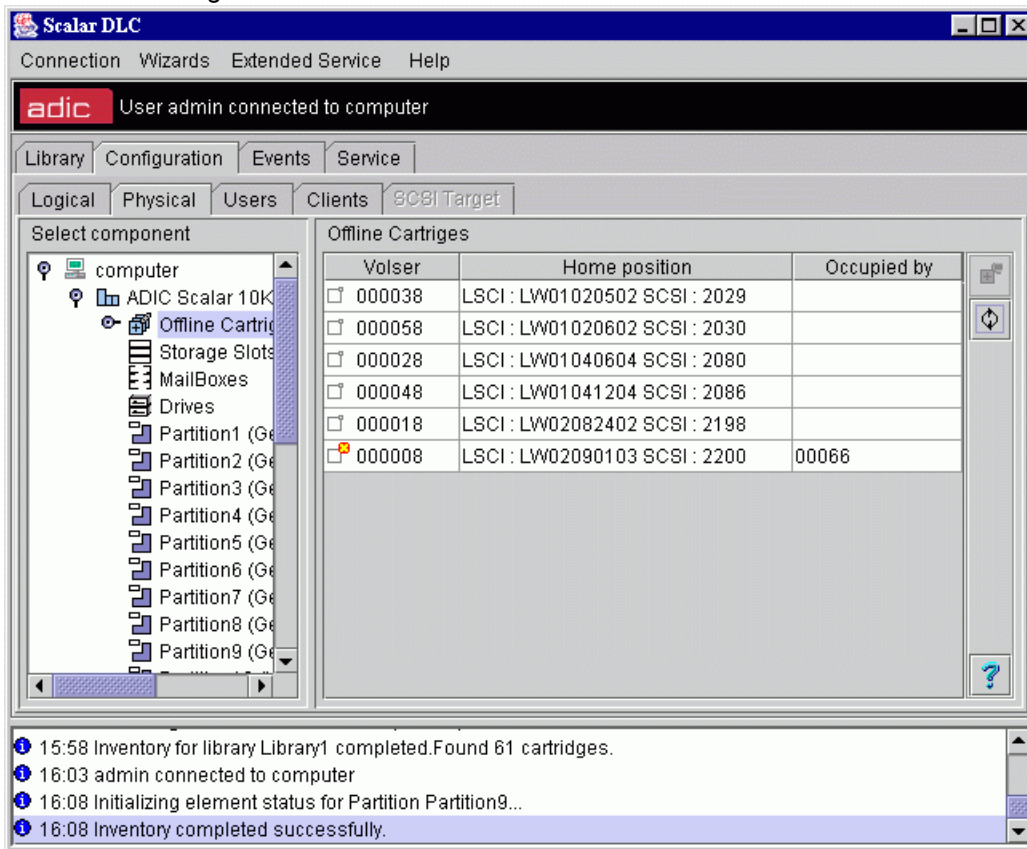

Field/Button	Icon	Operation	Description
Volser		Supplied	Data cartridge offline, home position is free.
			Cleaning cartridge offline, home position is free.
			Data cartridge offline, home position is occupied.
			Cleaning cartridge offline, home position is occupied.
Home position		Supplied	An offline cartridge home position, in both LSCI and SCSI format. Refer to Element Addressing on page 244.
Occupied by		Supplied	A cartridge that occupies offline cartridge home slot, if any.
Remove		Click	Remove selected offline cartridge(s) from the archive.
Refresh		Click	Force refresh the offline cartridges and apply changes in case of any difference. The offline cartridges list itself is not refreshed.
Help		Click	Open online help for the current pane.

To remove a cartridge from the archive list of the offline cartridges, select it and press **Remove** button. Multiple cartridges can be selected by the <Ctrl>+Click, too, and removed the same way.

Selecting a single cartridge opens Offline Cartridge pane with its properties.

Figure 90 Offline Cartridge

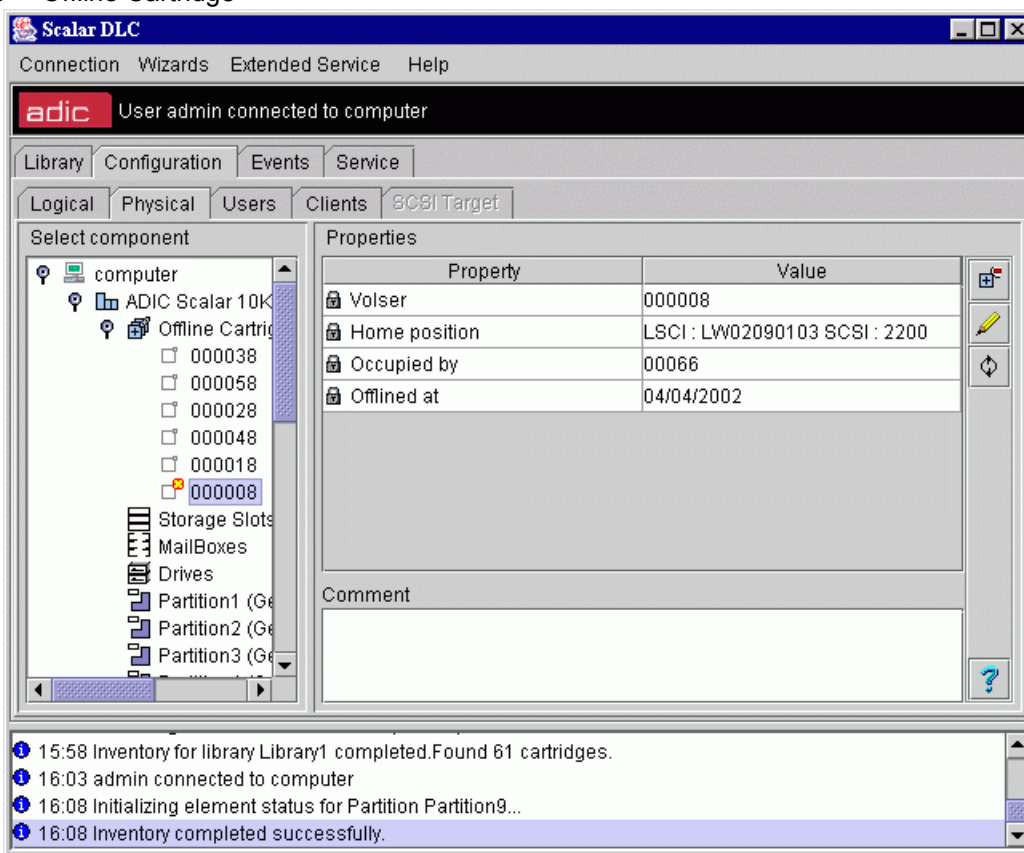



Field/Button	Icon	Operation	Description
Volser		Supplied	Offline cartridge name.
Home position		Supplied	An offline cartridge home position, both SCSI and LSCI format. Refer to Element Addressing on page 244.
Occupied by		Supplied	A cartridge that occupies offline cartridge home slot, if any.
Offlined at		Supplied	The date (mm/dd/yyyy) when the cartridge has gone to <i>offline</i> .
Comment		Enter	The comment about the situation with the cartridge (for example, the reason why it is offline).
Remove		Click	Removes an offline cartridge from the archive.
Update		Click	Save offline cartridge properties after edit.
Refresh		Click	Force refresh the offline cartridges and apply changes in the event of any difference. The offline cartridges list itself is not refreshed.
Help		Click	Open online help for the current pane.

Storage Slots

In the *Select Components* area of the pane, selectable Storage Slots are displayed.

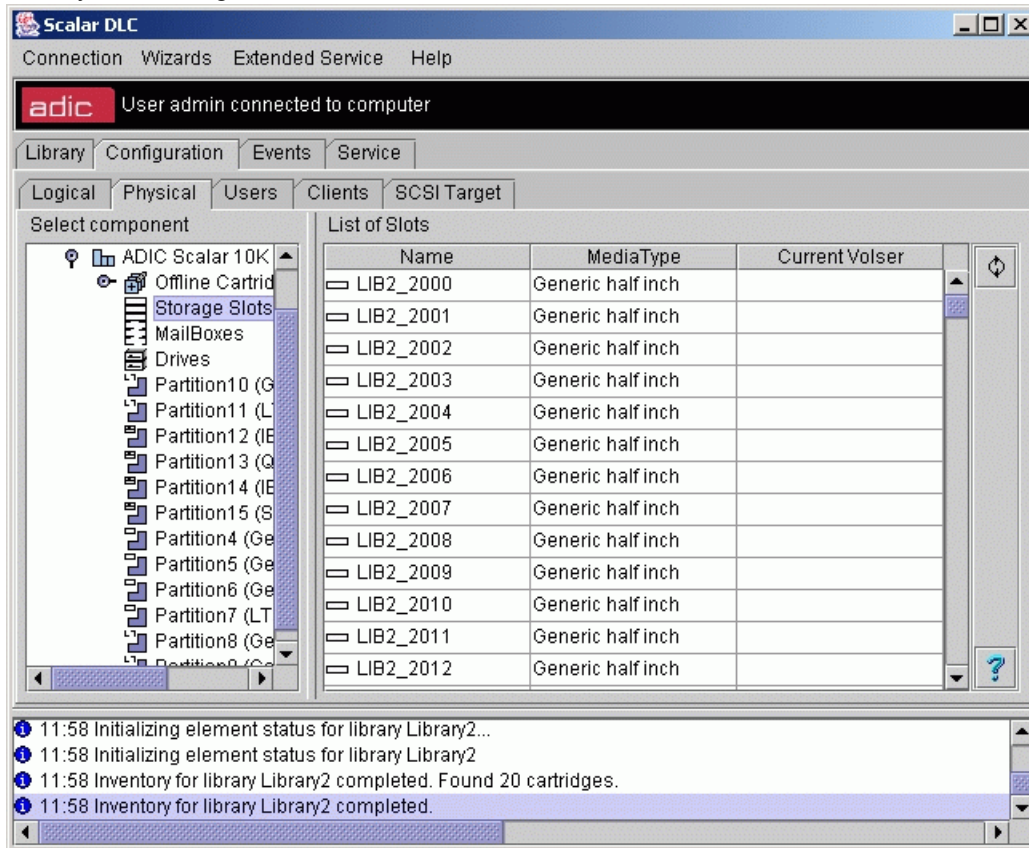
Figure 91 Physical Storage Slots





Field/Button	Icon	Operation	Description
Name		Supplied	The slot name. The icon also shows the slot state. See Table 14 on page 65.
Media Type		Supplied	The slot type. Refer to Storage Types on page 247.
Current volser		Supplied	If the slot is occupied, a contained cartridge is shown. For the optical disk, two cartridges are shown.
Refresh		Click	Force refresh the cartridge list and apply changes in case of any difference.
Help		Click	Open online help for the current pane.

Mailboxes

In the *Select Components* area of the pane, selectable Mailboxes is displayed.

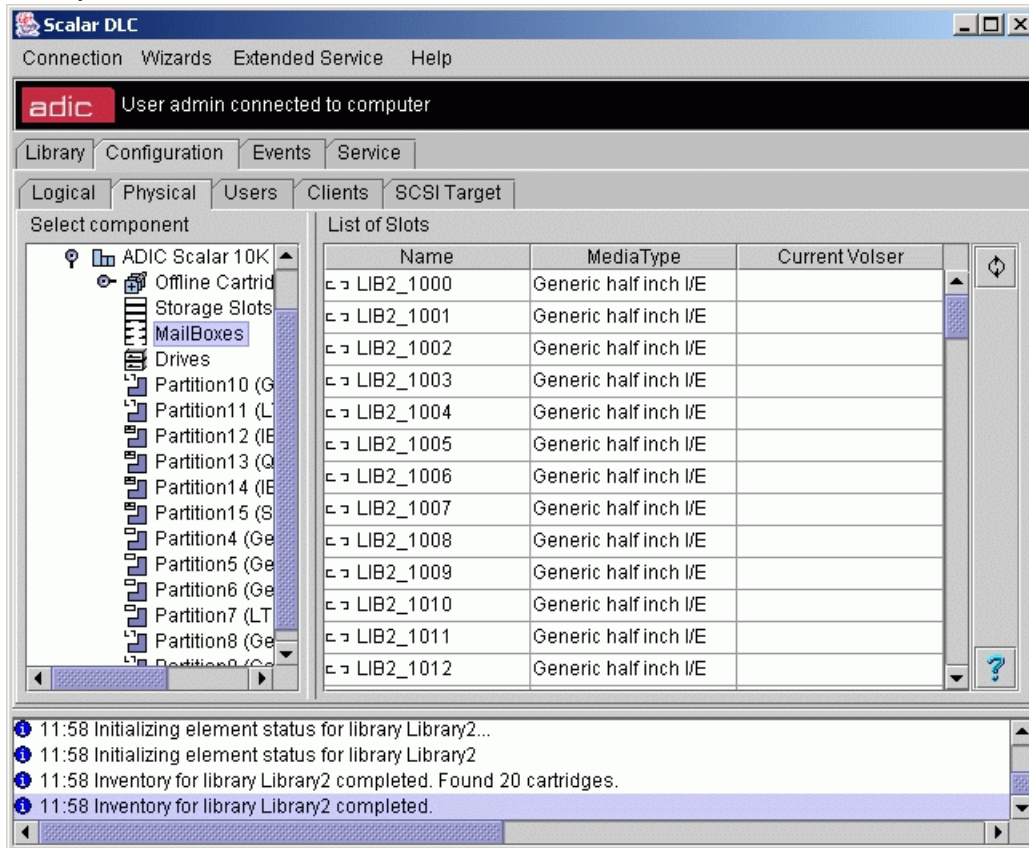
Figure 92 Physical Mailboxes





Field/Button	Icon	Operation	Description
Name		Supplied	The slot name. The icon also shows the slot state. See Table 15 on page 66.
Media Type		Supplied	The slot type. Refer to Mailbox Types on page 248.
Current volser		Supplied	If the slot is occupied, the contained cartridge is shown. For the optical disk, two cartridges are shown.
Refresh		Click	Force refresh the cartridge list and apply changes in the event of any difference.
Help		Click	Open online help for the current pane.

Drives

In the *Select Components* area of the pane, selectable Drives appear.

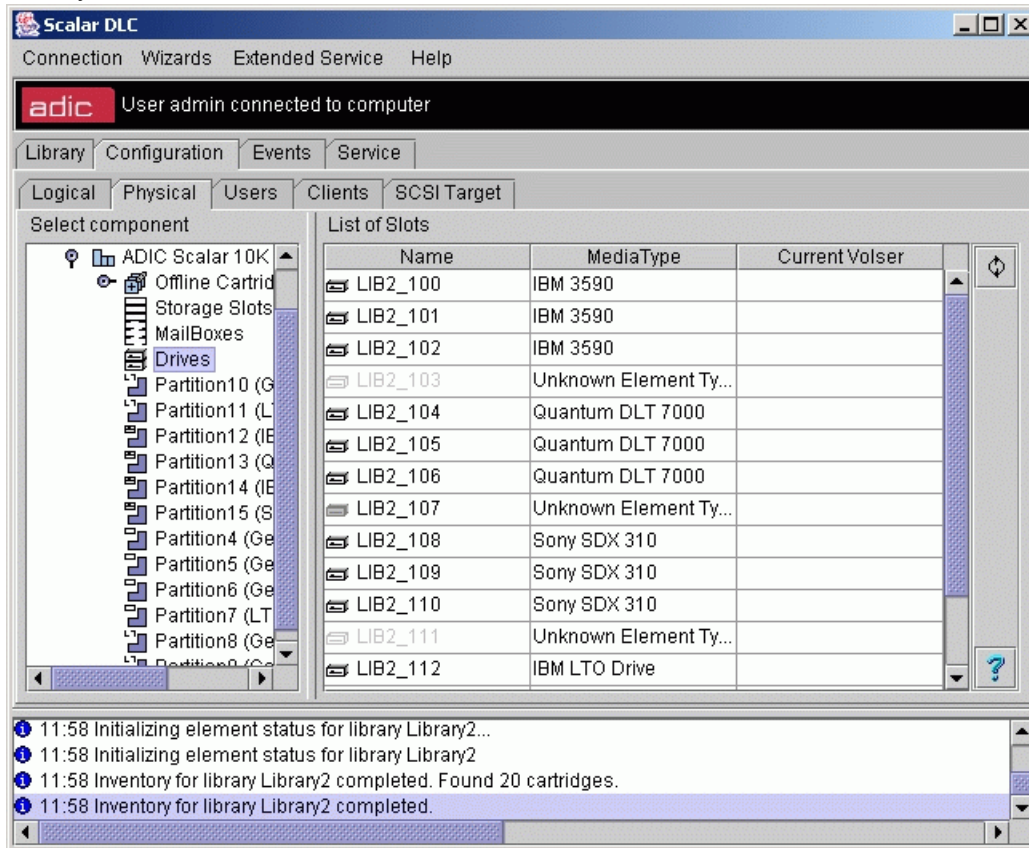
Figure 93 Physical Drives



Field/Button	Icon	Operation	Description
Name		Supplied	The slot name. The icon also shows the slot state. See Table 16 on page 67.
Media Type		Supplied	The slot type. Refer to Drive Types on page 249.
Current volser		Supplied	If the slot is occupied, the contained cartridge is shown. For the optical disk, two cartridges are shown, active side first.
Refresh		Click	Force refresh the cartridge list and apply changes in the event of any difference.
Help		Click	Open online help for the current pane.

Create Partition

Under the Library properties, the **Add new Partition** button appears. Click it to open a pop-up partition creation pane.









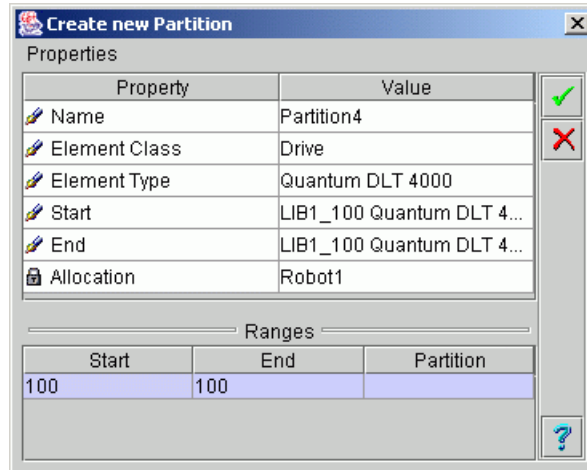

 **Note** Only administrator users can create the partitions. For the user without administrative privileges, the **Add new Partition** button is disabled.

Figure 94 Partition Creation



Field/Button	Icon	Operation	Description
Name		Enter	Partition name. Should be unique throughout all physical libraries. Also refer to Table 6 on page 16.
Element class		Supplied	Partition class (storage, I/E, drive). See Table 13 on page 65.
Element type		Supplied	Partition element type. Refer to Storage Types on page 247, Mailbox Types on page 248, or Drive Types on page 249.
Start		Supplied	Start element of partition range.
End		Supplied	End element of partition range.
Allocation		Supplied	<i>Robot1 / Robot2</i> indicates the robotic device where the partition is located. <i>Shared</i> means the partition is shared between two robots.
Ranges		Supplied	The element ranges of selected class and type inside the current physical library. The ranges already containing the partitions are shown in gray, and the partition name is indicated. The ranges that are free for the new partition are shown in black.
Create		Click	Create partition.



Field/Button	Icon	Operation	Description
Cancel		Click	Cancel creation.
Help		Click	Open online help for the current pane.

 **Note** Using the default partition name is recommended but not required.

Users Tab

The user is the person who has the rights to log on the Scalar DLC Management GUI.

All users have access to the Users Tab. Users that are known to the Scalar DLC software are indicated by different icons.

Name	Icon	Description
Logged user		A user is currently logged into the system
Not logged user		A user is not logged into the system.

The user access lever is described in [Table 20](#).

Table 20 User Access Level

Access Level	Explanation
Admin	Administrator of Management GUI is authorized to create/manage configuration and execute all service operations. Refer to Table 21 on page 129.
CE	Customer Engineer is authorized ot manage customer requests (tickets) and execute basic operations. Refer to Table 21 on page 129.
User	Typical user with changeable rights. Refer to Table 21 on page 129.

Depending on the access level, the user may have additional rights to manage the Scalar DLC via the Management GUI and execute some Scalar DLC operations. The user access level cannot be changed, however the administrator can grant the user additional rights beyond those of a typical user. Refer to [Table 21](#) on page 129 for the details.

Table 21 User Rights

Privilege	Description	User Access Level		
		Admin	User	CE
Change configuration	<ul style="list-style-type: none"> • Manage Logical library, Pools, Mailboxes, Cartridges • Scan SCSI bus; stop/start robotic controller; manage the partitions of Physical library • Manage barcode reader and command execution • Manage Media rules • Manage Users and user rights • Manage Clients, reserve slots and cartridges, define drives and cartridges • Manage SCSI Targets and LUNs • Manage command queue • Manage Cluster settings • Manage SNMP settings 	Yes	No	No
Logical library manipulation	<ul style="list-style-type: none"> • Inventory 	Yes	Yes/No	Yes/No
Standard move commands	<ul style="list-style-type: none"> • Mount • Dismount • Import • Export • Drag&drop 	Yes	Yes/No	Yes/No
Expert move commands	<ul style="list-style-type: none"> • Move • Execute logical library diagnostic tests 	Yes	No/Yes	Yes/No
Rules manipulation	<ul style="list-style-type: none"> • Create rule • Remove rule • Update rule 	Yes	No/Yes	No
Logs manipulation	<ul style="list-style-type: none"> • Save log to file • Send log via email 	Yes	No/Yes	Yes/No
Physical library diagnostic	<ul style="list-style-type: none"> • Execute service diagnostic for the robotic accessor 	Yes	No/Yes	Yes/No
Acknowledge notification	<ul style="list-style-type: none"> • Acknowledge the notification sent via Management GUI 	Yes	Yes/No	No/Yes
Ticket manipulation	<ul style="list-style-type: none"> • Update problem report • Close problem report • Remove problem report 	No/Yes	No	Yes

The starting Users pane shows the properties of Scalar DLC host PC.

Figure 95 User Controller

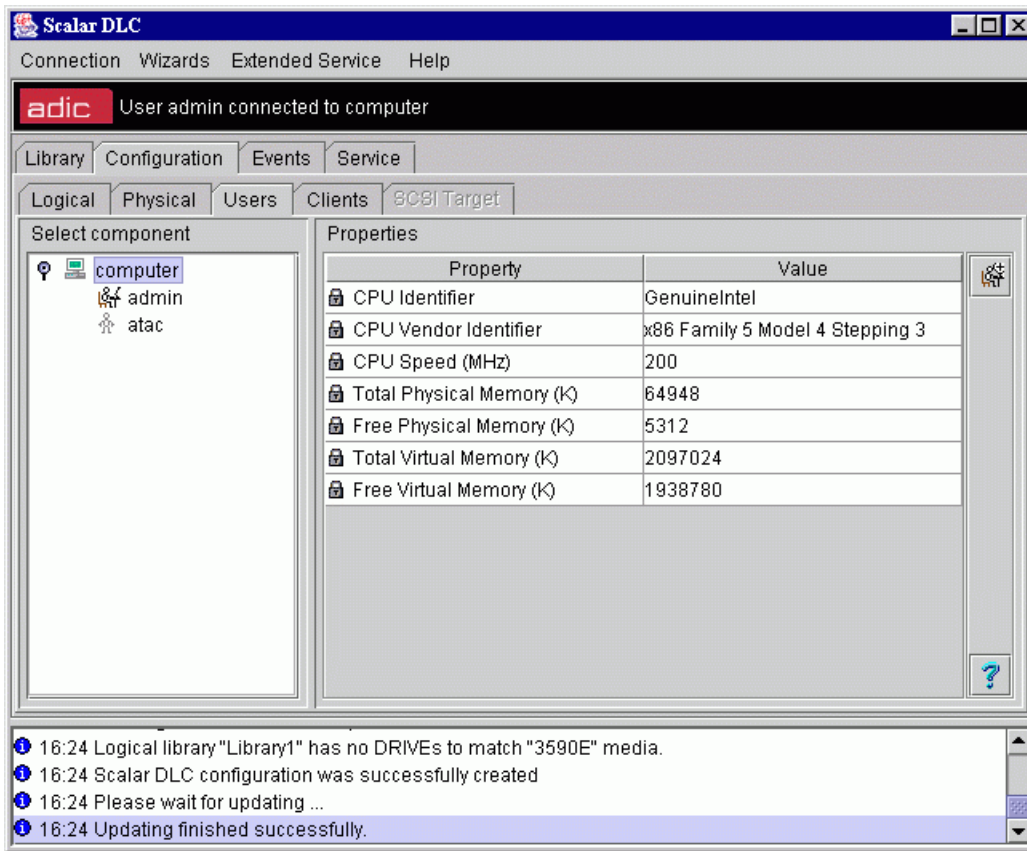

Field/Button	Icon	Operation	Description
CPU Identifier		Supplied	The CPU identifier
CPU Vendor ID		Supplied	The CPU vendor identifier
CPU Speed		Supplied	The CPU speed
Total physical memory		Supplied	The total physical memory size
Free physical memory		Supplied	The free physical memory size
Total virtual memory		Supplied	The total virtual memory size
Free virtual memory		Supplied	The free virtual memory size
Add new User		Click	Pop-up user creation window appears. Refer to Create User on page 132.
Help		Click	Open online help for the current pane.



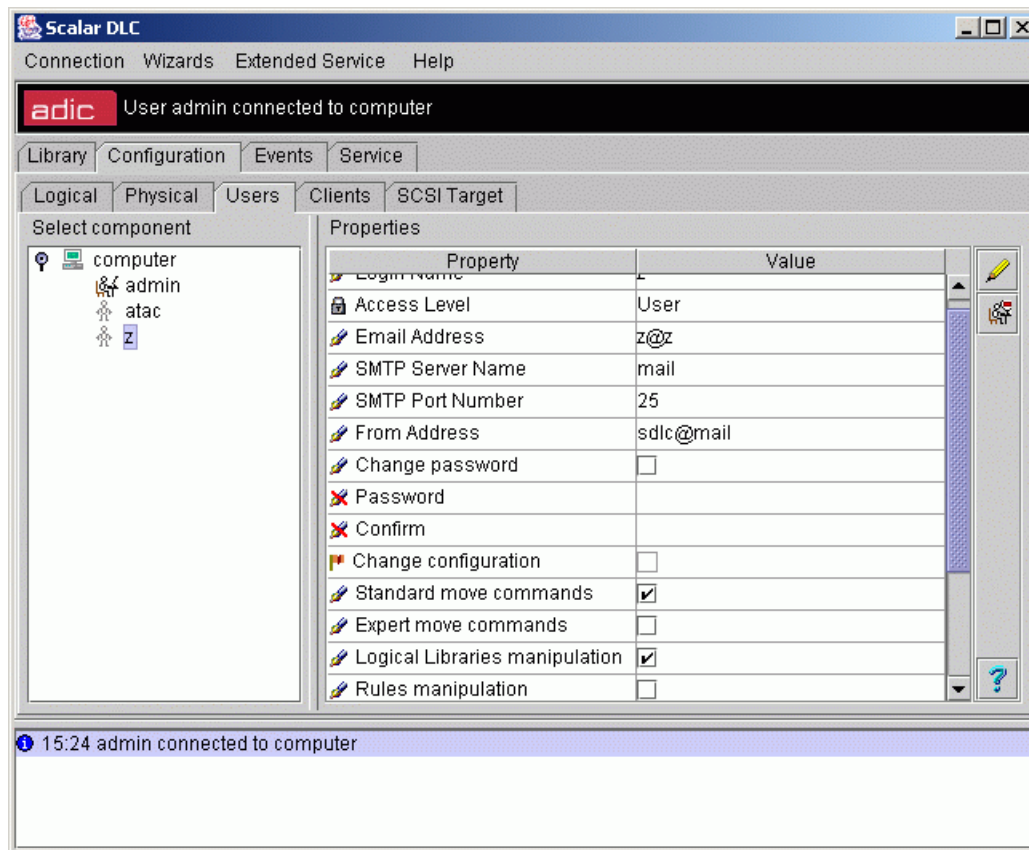

User

The *Select Component* area of the pane indicates a list of users. When the user is selected from the list, the user is highlighted.

Figure 96 User



Field/Button	Icon	Operation	Description
Logon Name		Enter	User logon name (changeable).
Access Level		Supplied	User access level (refer to Table 20 on page 128).
Email Address		Enter	User's email when sending notifications.
SMTP Server Name		Enter	SMTP server name.
SMTP Port Number		Enter	SMTP port number.
From Address		Enter	Email address appears in the email field <i>from</i> .
Change password		Check	If the field is checked, the <i>password</i> and <i>confirm</i> fields become editable. Otherwise, user's password cannot be changed. Note that the user cannot change own password.
Password		Supplied	User's password must be entered here.
Confirm		Supplied	User's password must be confirmed here.

Field/Button	Icon	Operation	Description
User rights		Check	The list of user rights as described in Table 21 on page 129.
		Supplied	
Update		Click	Save user properties after edit.
Remove		Click	Remove the user. The user cannot remove himself.
Help		Click	Open online help for the current pane.

 **Note** Even though the email server parameters are configured during the installation, the value can be edited.

 **Note** User access level is not changeable after it is created. The default CE **atac** cannot be removed. The user cannot remove himself.

Create User

Under the Controller properties, the **Add new User** button appears. Clicking it opens a pop-up user creation pane.











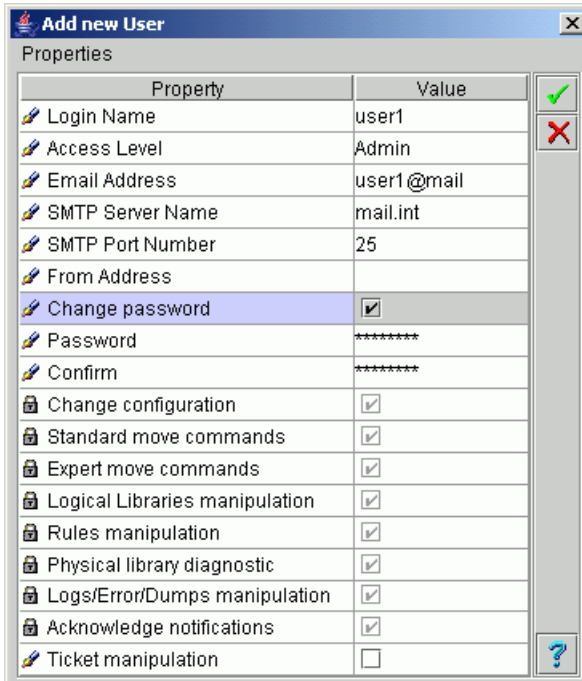



 **Note** Only administrator users can create additional users. For the user without administrative privileges, the **Add new User** button is disabled.

Figure 97 User Creation



Property	Value
Login Name	user1
Access Level	Admin
Email Address	user1@mail
SMTP Server Name	mail.int
SMTP Port Number	25
From Address	
Change password	<input checked="" type="checkbox"/>
Password	*****
Confirm	*****
Change configuration	<input checked="" type="checkbox"/>
Standard move commands	<input checked="" type="checkbox"/>
Expert move commands	<input checked="" type="checkbox"/>
Logical Libraries manipulation	<input checked="" type="checkbox"/>
Rules manipulation	<input checked="" type="checkbox"/>
Physical library diagnostic	<input checked="" type="checkbox"/>
Logs/Error/Dumps manipulation	<input checked="" type="checkbox"/>
Acknowledge notifications	<input checked="" type="checkbox"/>
Ticket manipulation	<input type="checkbox"/>



Field/Button	Icon	Operation	Description
Logon Name		Enter	User logon name.
Access Level		Select	User access level (refer to Table 20 on page 128).
Email Address		Enter	User's email when sending notifications.
SMTP Server Name		Enter	SMTP server name.
SMTP Port Number		Enter	SMTP port number.
From Address		Enter	Email address appears in the email field <i>from</i> .
Change password		Check	If the field is checked, the <i>password</i> and <i>confirm</i> fields become editable. Otherwise, user's password cannot be changed.
Password		Supplied	User's password must be entered here.
Confirm		Supplied	User's password must be confirmed here.
User rights		Check	The list of user rights as described in Table 21 on page 129.
		Supplied	
Create		Click	Create user.
Cancel		Click	Cancel creation.
Help		Click	Open online help for the current pane.

Clients Tab

Clients connect to the Scalar DLC software through various interfaces. This release of Scalar DLC software supports application-based DAS, ROBAR, and SCSI clients. A host software application client connects through the DAS or ROBAR interface, or SCSI.

The selected client area of the pane indicates a list of clients. When a client is selected from the list, the client is highlighted.

Table below shows the icons that represent the Clients tab objects.

Name	Icon	Description
Client interface		A client interface (DAS, SCSI, and ROBAR).
Client (online)		This icon indicates a client that is currently online.
Client (offline)		This icon indicates a client that is currently offline.

The three compatible client interfaces are:

- DAS. Refer to [DAS](#) on page 135.
- SCSI. Refer to [SCSI](#) on page 146.
- ROBAR. Refer to [ROBAR](#) on page 156.



Note

DAS and SCSI clients are considered online when a client-sent command is being executed. ROBAR client is considered online when a TCP/IP connection with the client host is established.

DAS

The DAS Interface needs no pre-configuration.

Figure 98 DAS Interface Pane

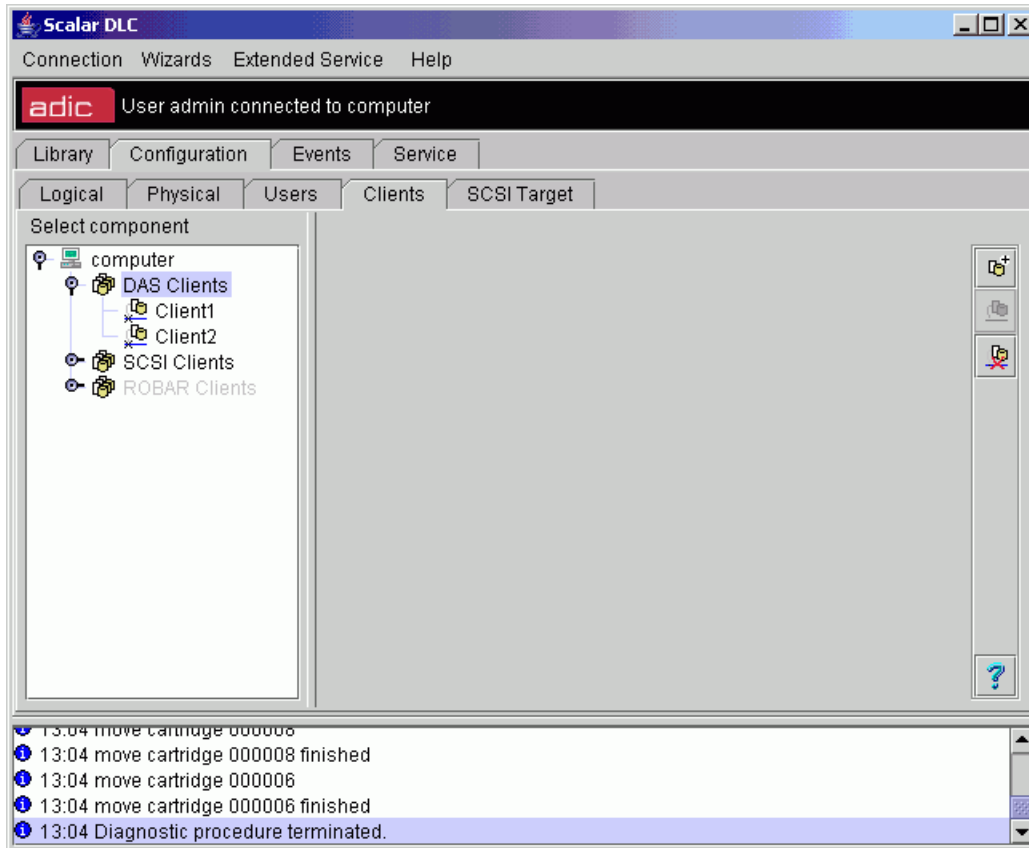

Button	Icon	Operation	Description
Add new Client		Click	Pop-up client creation window appears. Refer to Create DAS Client on page 144.
Enable		Click	Enable DAS Interface.
Disable		Click	Disable DAS interface. All requests send by DAS Clients will receive 'interface is disabled' error.
Help		Click	Open online help for the current pane.

DAS Client

There are four sets of properties associated with the DAS Client:

- Properties. The basic client properties, statistics, and operational settings. Refer to [Properties](#) on page 136.
- Drives. The list of drives that are reserved for the clients and that are defined for the selected client. Refer to [Drives](#) on page 138.

- Volsers. The list of volsers (cartridges) that are reserved and that are defined for the selected client. Refer to [Volsers](#) on page 141.
- Aliasing. The media and drive aliasing properties for the selected client. Refer to [Aliasing](#) on page 143.









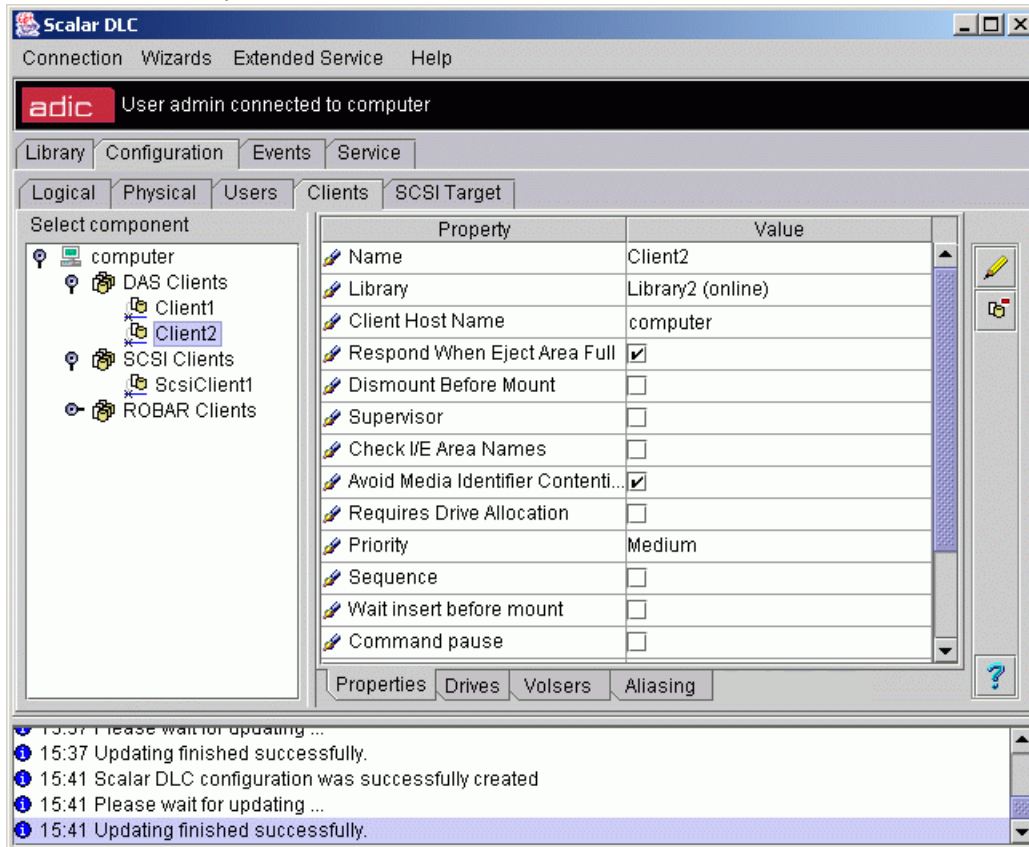





Note Only administrator users can modify or remove clients. For the user without administrative privileges, the operation buttons are disabled.







Properties

Figure 99 DAS Client Properties



Field/Button	Icon	Operation	Description
Name		Enter	The client name. It must not duplicate an existing client name. Also refer to Table 6 on page 16.
Library		Select	The client will operate with the selected logical library and its resources.

Field/Button	Icon	Operation	Description
Client Host Name		Enter	The host name of the computer running the client software. ADIC recommends using the following: <ul style="list-style-type: none"> • client host IP address • client host DNS name, short • client host DNS name, full • <i>localhost</i> for the client operating from local host (possible but not recommended because of security reasons) • <i>any</i> for the client operating from any host (possible but not recommended because of security reasons)
Respond When Eject Area Full		Check	Scalar DLC software returns an error (Area Full) if the client tries to eject a cartridge into an eject area with no free slots.
Dismount Before Mount		Do not check	Scalar DLC software does not execute a dismount when a client tries to mount a cartridge into an occupied drive.
Supervisor		Do not check	A client without the supervisor rights is not authorized to use drives and/or cartridges that are reserved by another client.
Check I/E Area Names		Do not check	The I/E (mailbox) area names that can be used by the client are not limited with the DAS naming standard.
Avoid Media Identifier Contention		Check	Cartridge media identifiers are shown only as a result of executing a cartridge information operation.
Requires Drive Allocation		Do not check	A client does not need to reserve the drive before executing a mount or dismount.
Priority		Select	<i>Low</i> means the client-sent commands have the lowest priority in a queue. Refer to Queue Tab on page 174. <i>Medium</i> means the client-sent commands have the standard priority in a queue. Refer to Queue Tab on page 174. <i>High</i> means the client-sent commands have the highest priority in a queue. Refer to Queue Tab on page 174.
Sequence		Do not check	A commands sent by client without sequence option will be executed as they're ready. The system will not wait until the previous client command is finished.
Wait insert before mount		Do not check	A client without wait insert option cannot wait until the ejected cartridge will be inserted for the mount could be executed.
Command pause		Do not check	A client without command pause rights is not authorized to execute " pausedas " DAS command.
Drive pause		Do not check	A client without drive pause rights is not authorized to execute " pausedrive " DAS command.

Field/Button	Icon	Operation	Description
Number of reserved storages		Supplied	The total number of storage slots reserved by the client.
Number of reserved I/E slots		Supplied	The total number of mailbox (I/E) slots reserved by the client.
Number of reserved drives		Supplied	The total number of drives reserved by the client.
Update		Click	Save client properties after edit.
Remove		Click	Remove the client.
Help		Click	Open online help for the current pane.



Note





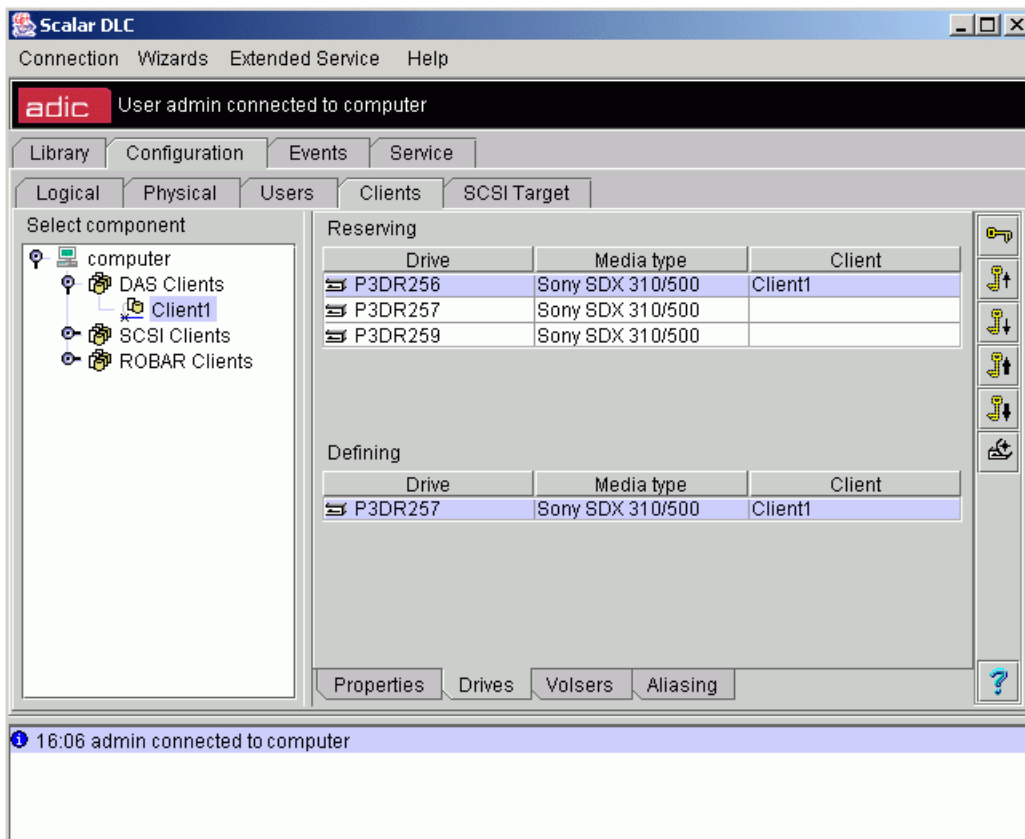

If a firewall exists between the client host and the Scalar DLC, the DAS/ACI firewall PC should be specified under the client host name. Refer to *Scalar DLC Installation Guide, Installing DAS Client* section.

Drives

The Drives pane shows the list of all drives in the library, defines what drives are defined to the current client, shows the drives reserved by the client, and allows the status to be changed.

Figure 100 DAS Client Drives



Field/Button	Icon	Operation	Description
Reserving		Supplied	The drive reserving list.
		Select	Drive The drive name.
		Select	Media Type The drive type. Refer to Drive Types on page 249.
		Select	Client The drive owner, if any.
Defining		Supplied	The drive defining list.
		Select	Drive The drive name.
		Select	Media Type The drive type. The drive type. Refer to Drive Types on page 249.
		Select	Client The drive owner.
Unreserve All		Click	Unreserve all slots currently reserved for the client (storage, I/E, and drives).
Up		Click	Reserve the selected drive for the client, the drive should be empty. Has the same effect as the DAS command “ allocd drive UP ”. Refer to <i>DAS Administration Guide</i> .
Down		Click	Unreserve the selected drive for the client, the drive should be empty. Has the same effect as the DAS command “ allocd drive DOWN ”. Refer to <i>DAS Administration Guide</i> .
Force Up		Click	Reserve the selected drive for the client. Has the same effect as the DAS command “ allocd drive FUP ”. Refer to <i>DAS Administration Guide</i> .
Force Down		Click	Unreserve the selected drive for the client. Has the same effect as the DAS command “ allocd drive FDOWN ”. Refer to <i>DAS Administration Guide</i> .
Define		Click	Open pop-up Define Drives pane. See Figure 101 on page 140.
Help		Click	Open online help for the current pane.

 **Note**

The client may access only the reserved drives if there is **Requires Drive Allocation** property checked (refer to [Properties](#) on page 136); if this property is not checked, the client does not need reserving the drive(s).

Reserving drive(s) however guaranties that no other client will access the reserved drive, especially when the reservation is exclusive (refer to [Drive](#) on page 104).

Define Drives

The drives defined by the client may represent only the drives that are currently installed and successfully recognized by the library.



CAUTION

The client with no drives defined (empty list) may access all drives in the logical library. The client with drives defined may access only the defined drives.

Figure 101 Define Drives

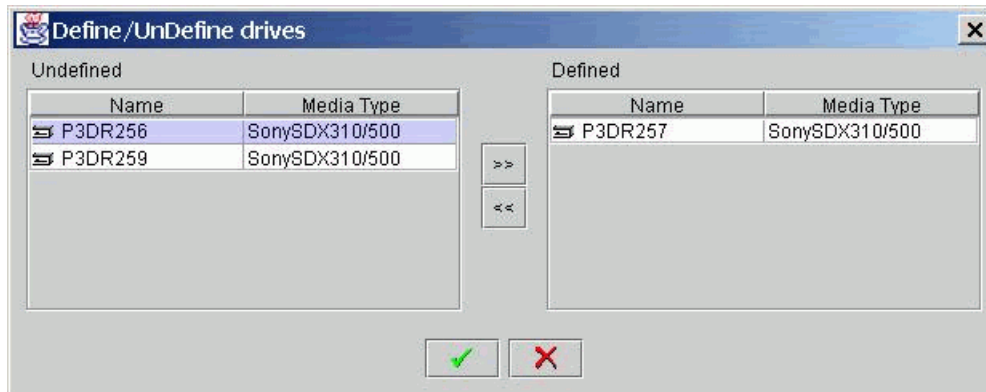

With the arrow buttons define the required drive(s) for the current client. Press **OK** when finish. Press **Cancel** to exit without changing the drive defining settings.



Volsers

The Volsers pane describes the volser ranges reservation and definition list for the DAS clients authorized to work with the library.

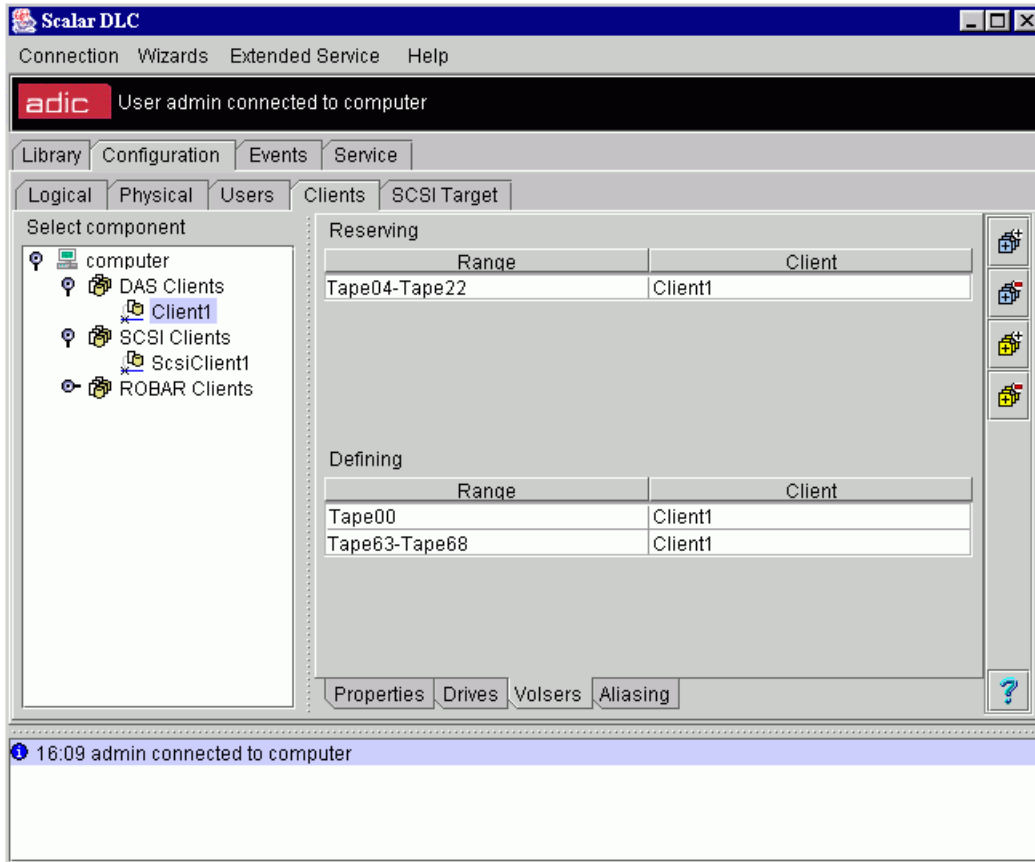
Figure 102 DAS Client Volsers



Field/Button	Icon	Operation	Description	
Reserving		Supplied	Reserving volser list.	
		Select	Range	The volser range. It can be either a single volser or a range separated by a hyphen.
		Select	Client	An owner of the volser range.
Defining		Supplied	Defining volser list.	
		Select	Range	The volser range. It can be either a single volser or a range separated by a hyphen.
		Select	Client	An owner of the volser range.
Add Reserved Range		Click	Pop-up volser range reservation window appears. See Figure 103 on page 142.	
Remove Reserved Range		Click	Remove the selected volser range from the list of reserved volsers.	

Field/Button	Icon	Operation	Description
Add Defined Range		Click	Pop-up volser range definition window appears. See Figure 103 on page 142.
Remove Defined Range		Click	Remove the selected volser range from the list of defined volsers
Help		Click	Open online help for the current pane.

Reserve or Define Volsers

The volsers reserved or defined for the client may represent the cartridges that are currently not in the library. However, if the cartridge appears in the library, it is marked automatically as 'allocated'/reserved, or 'defined', and can be accessed and managed only by its owner. The ownership can be changed either by the client himself or by the Scalar DLC Management GUI administrator.



Note

The client may access all cartridges in the logical library and does not need to reserve volsers before using media.

Reserving volser(s) however guaranties that no other client will access the reserved media, especially when the reservation is exclusive (refer to [Cartridge](#) on page 94).

Figure 103 Reserve/Define Volser Range

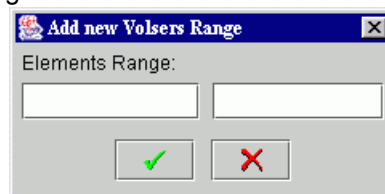

Enter the start and end volser in the range. Press **OK** to reserve/define them for the current client. Press **Cancel** to exit without adding volsers to the range of reserved or defined volsers.



Note

The client cannot reserve or define only half of an optical disk. Only the whole disk can be reserved/defined. Even if the volser reservation or definition table contains only one volser for the one side, the other is also reserved/defined for the client. This is shown under Cartridge properties (refer to [Cartridge](#) on page 94).



CAUTION

The client with no volsers defined (empty list) may access all cartridges in the logical library. The client whose volser defining list is not empty may access only the defined cartridges.

Aliasing

The DAS Client Aliasing feature is required for certain DAS interface-based applications that use the media type and element type that differs from default Scalar-based types.





Note

DAS Client aliasing takes effect only on the data output in DAS interface, and only on the client that has executed this aliasing.

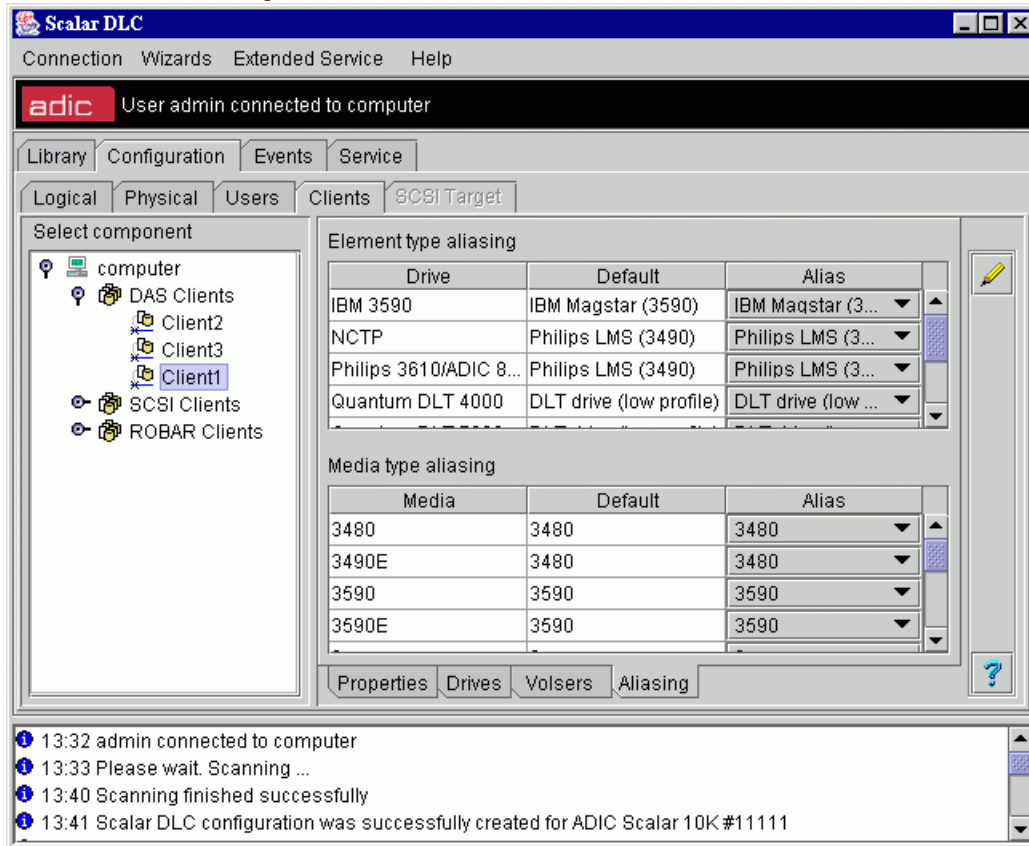
Figure 104 DAS Client Aliasing



Field/Button	Icon	Operation	Description
Element type aliasing	Supplied	Assign the alias to the drive accessible by the client.	
Drive	Supplied	The drive type in the library accessible by the client.	
Default	Supplied	The drive type as in the Scalar DLC-DAS specification. Refer to Drive Types on page 249 and also to the <i>DAS Administration Guide</i> . Old models of drives are seldom used in modern tape libraries, but still supported by some backup applications.	
Alias	Select	The same drive type that is in the client specification.	
Media type aliasing	Supplied	Assigns the alias to the media accessible by the client.	
Media	Supplied	The media type in the library accessible by the client.	
Default	Supplied	The same media type that is in the Scalar DLC-DAS specification. Refer to Media Types on page 246.	

Field/Button	Icon	Operation	Description
Alias		Select	The media type as in the client specification.
Update		Click	Save client properties after edit.
Help		Click	Open online help for the current pane.

Create DAS Client



Under the DAS Interface properties, the **Add new Client** button appears. Clicking it opens a pop-up client creation pane.





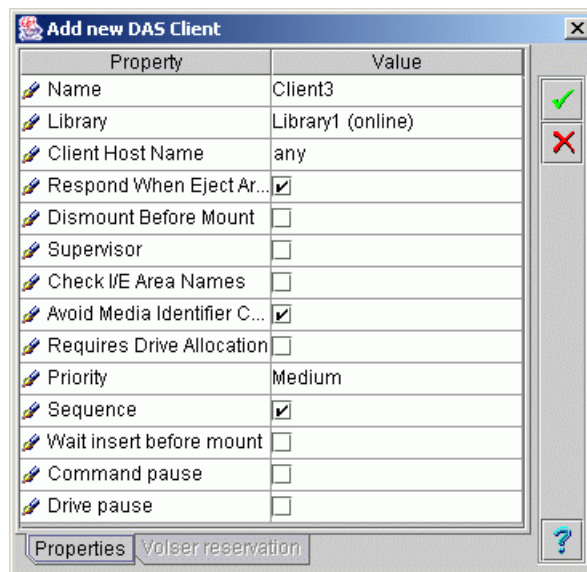







 **Note** Only administrator users can create additional clients. For the user without administrative privileges, the **Add new Client** button is disabled.



It is recommended that the default name be accepted, but it is not required. Be sure that the name specified manually does not duplicate an existing client name.

Figure 105 DAS Client Creation



Field/Button	Icon	Operation	Description
Name		Enter	The client name. It must not duplicate an existing client name. Also refer to Table 6 on page 16.
Library		Select	The client will operate with the selected logical library and its resources.

Field/Button	Icon	Operation	Description
Client Host Name		Enter	The host name of the computer running the client software. ADIC recommends using the following: <ul style="list-style-type: none"> • client host IP address • client host DNS name, short • client host DNS name, full • <i>localhost</i> for the client operating from local host (possible but not recommended because of security reasons) • <i>any</i> for the client operating from any host (possible but not recommended because of security reasons)
Respond When Eject Area Full		Check	Scalar DLC software returns an error (Area Full) if the client tries to eject a cartridge into an eject area with no free slots.
Dismount Before Mount		Do not check	Scalar DLC software does not execute a dismount when a client tries to mount a cartridge into an occupied drive.
Supervisor		Do not check	A client without the supervisor rights is not authorized to use drives and/or cartridges that are reserved by another client.
Check I/E Area Names		Do not check	The I/E (mailbox) area names that can be used by the client are not limited with the DAS naming standard.
Avoid Media Identifier Contention		Check	Cartridge media identifiers are shown only as a result of executing a cartridge information operation.
Requires Drive Allocation		Do not check	A client does not need to reserve the drive before executing a mount or dismount.
Priority		Select	<i>Low</i> means the client-sent commands have the lowest priority in a queue. Refer to Queue Tab on page 174. <i>Medium</i> means the client-sent commands have the standard priority in a queue. Refer to Queue Tab on page 174. <i>High</i> means the client-sent commands have the highest priority in a queue. Refer to Queue Tab on page 174.
Sequence		Do not check	A commands sent by client without sequence option will be executed as they're ready. The system will not wait until the previous client command is finished.
Wait insert before mount		Do not check	A client without wait insert option cannot wait until the ejected cartridge will be inserted for the mount could be executed.
Command pause		Do not check	A client without command pause rights is not authorized to execute " pausedas " DAS command.
Drive pause		Do not check	A client without drive pause rights is not authorized to execute " pausedrive " DAS command.

Field/Button	Icon	Operation	Description
Create		Click	Create client.
Cancel		Click	Cancel creation.
Help		Click	Open online help for the current pane.

 **Note** If a firewall exists between the client host and the Scalar DLC, under the client host name, specify the DAS/ACI firewall PC name. Refer to *Scalar DLC Installation Guide, Installing DAS Client* section.





 **Note** The new DAS Client is functional immediately after creation. No Scalar DLC service restart is required.

SCSI

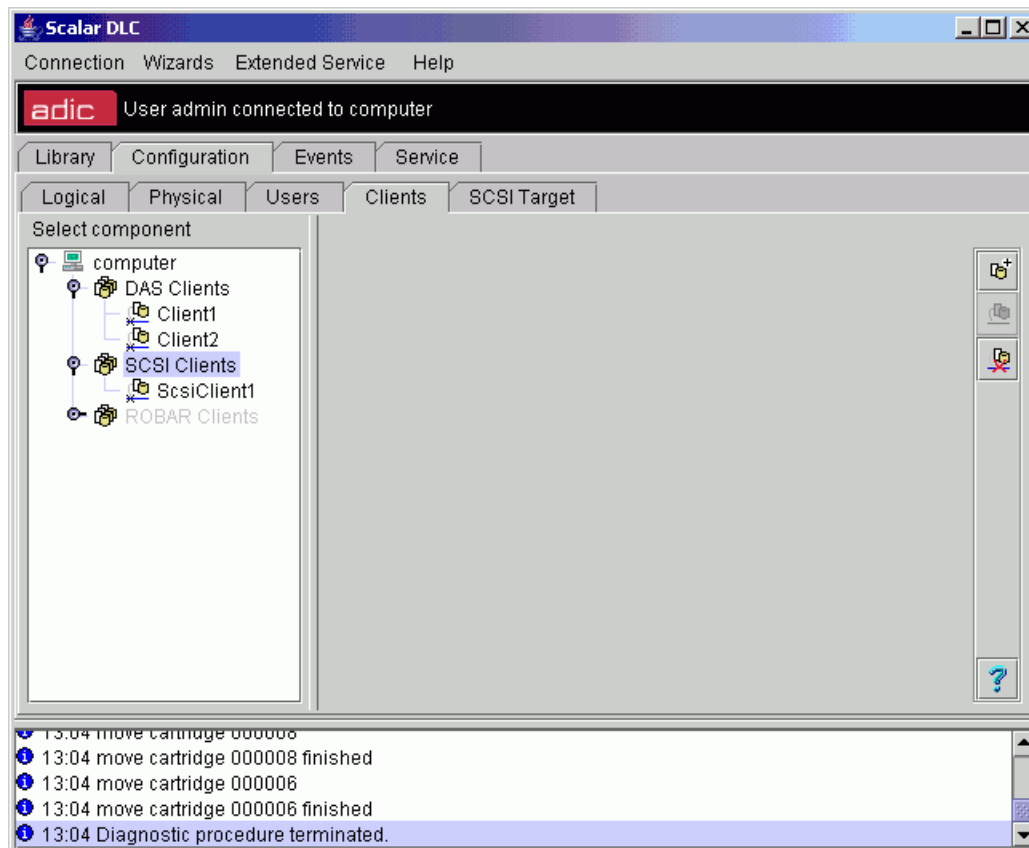
All the operations with the SCSI Clients are enabled only after the configuration of SCSI Target software. That can be done via the SCSI Target tab. Refer to [SCSI Target Tab](#) on page 162.

Figure 106 SCSI Pane



Button	Icon	Operation	Description
Add new Client		Click	Pop-up client creation window appears. Refer to Create SCSI Client on page 155.
Enable		Click	Enable SCSI Interface.
Disable		Click	Disable SCSI interface. The following commands are serviced in the regular way then: <ul style="list-style-type: none"> • Inquiry for the <i>Standard Inquiry Data</i> page • Request Sense • Report LUNs (SCSI-3 mode) All other commands and the Inquiry command for other pages are rejected with the CHECK CONDITION SCSI status, and 02/04/00 “Not ready due to unknown cause” SCSI sense data.
Help		Click	Open online help for the current pane.

SCSI Client

There are five sets of properties associated with the SCSI Client.

- Properties. Main client properties. Refer to [Properties](#) on page 148.
- Mode. SCSI mode parameters. Refer to [Mode](#) on page 150.
- Drives. The library drives as they are seen from the client side. Refer to [Drives](#) on page 152.
- I/E slots. The library I/E slots as they are seen from the client side. Refer to [I/E Slots](#) on page 153.
- Storages. The library storages as they are seen from the client side. Refer to [Storages](#) on page 154.

 **Note** Only administrator users can modify or remove clients. For the user without administrative privileges, the operation buttons are disabled.





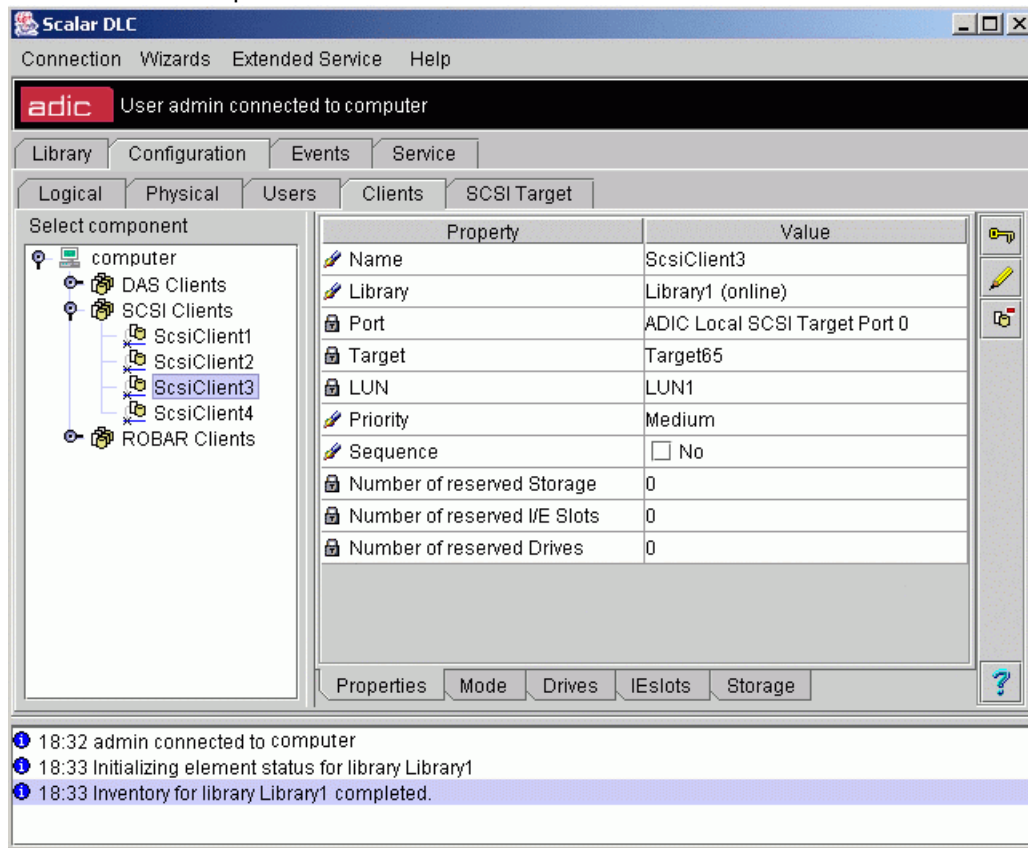



Properties

Figure 107 SCSI Client Properties



The SCSI Client Properties pane indicates the main client properties.

Field/Button	Icon	Operation	Description
Name		Enter	The client name. Also refer to Table 6 on page 16.
Library		Select	The client operates with the selected logical library.
Port		Supplied	The client is connected to the SCSI bus via the selected port.
Target		Supplied	The client is assigned to the selected target.
LUN		Supplied	The client is assigned to the selected LUN on the target.
Priority		Select	<i>Low</i> means the client-sent commands have the lowest priority in a queue. Refer to Queue Tab on page 174. <i>Medium</i> means the client-sent commands have the standard priority in a queue. Refer to Queue Tab on page 174. <i>High</i> means the client-sent commands have the highest priority in a queue. Refer to Queue Tab on page 174.

Field/Button	Icon	Operation	Description
Sequence		Do not check	A commands sent by client without sequence option will be executed as they are ready. The system will not wait until the previous client command is finished.
Number of reserved storages		Supplied	The number of storage slots reserved by the client.
Number of reserved I/E slots		Supplied	The number of mailbox (I/E) slots reserved by the client.
Number of reserved drives		Supplied	The number of drives reserved by the client.
Unreserve All		Click	De-allocates all slots currently reserved by the client (storage, I/E, and drives).
Update		Click	Save client properties after edit.
Remove		Click	Remove the client.
Help		Click	Open online help for the current pane.



CAUTION

The SCSI Client connection parameters (port-target-LUN) cannot be modified. It is only possible to remove the client, or change its name and the assigned library.



Note

Because of interface properties, only one SCSI Client can be assigned to the single LUN of the specified SCSI Target.



CAUTION

After the client is assigned to the LUN 0 of any target, all other clients assigned to the non-zero LUNs of this target are activated.

Mode

Figure 108 SCSI Client Mode

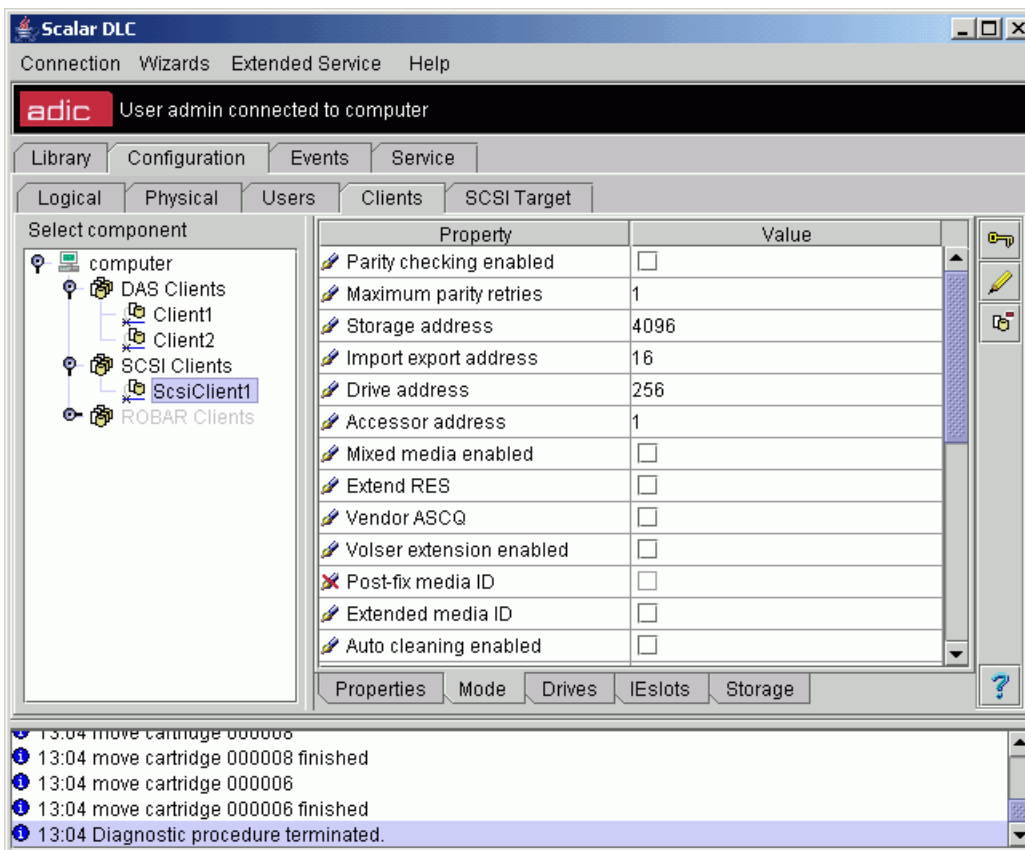























The SCSI Client Mode pane indicates the SCSI mode parameters.



Note

The details about SCSI Client Mode Parameters can be found in the *Scalar 10K Operator Guide* and the *Scalar 1000 Operator Guide (Mode Sense (1Ah) Response)*.

Field/Button	Icon	Operation	Description
Parity checking enabled		Do not check	Whether the parity checking enabled
Maximum parity retries		Enter	The maximum number of times to retry the message out, command out, or data out phase after a parity error.
Storage address		Enter	First storage address (0=default).
Import/export address		Enter	First mailbox address (0=default).
Drive address		Enter	First drive address (0=default).
Accessor address		Enter	Accessor address (0=default).
Mixed media enabled		Do not check	Manage whether the library operates in mixed media mode or not.

Field/Button	Icon	Operation	Description
Extended res		Do not check	Manage whether the Read Element Status and Request Volume Element Address commands return extended element status information.
Vendor Ascq		Do not check	The ASC/ASCQ returned if a Move Media command is issued to an incompatible location.
Volser extension enabled		Do not check	The Volser extension identification for Read Element Status and Request Volume Element Address commands.
Post-fix media ID		Supplied	The media ID pre-pend or post-pend. Selectable for the enabled <i>Volser Extension</i> .
Auto cleaning enabled		Do not check	Whether the auto-cleaning is enabled.
Delayed cleaning enabled		Do not check	Whether the delayed cleaning is enabled.
Cleaning hour		Enter	Cleaning schedule, hour.
Cleaning minute		Enter	Cleaning schedule, minute.
Auto teach enabled		Do not check	Whether the auto-teach is enabled.
Auto inventory enabled		Do not check	Whether the auto-inventory is enabled.
Operation mode		Enter	Operation mode parameter.
LCD security valid		Do not check	Whether the LCD security is valid.
LCD security enabled		Do not check	Whether the LCD security is enabled.
LCD write line1		Do not check	LCD write line1.
LCD write line2		Do not check	LCD write line2
LCD write line3		Do not check	LCD write line3
LCD write line4		Do not check	LCD write line4
LCD display line1		Enter	LCD display line1
LCD display line2		Enter	LCD display line2
LCD display line3		Enter	LCD display line3
Update		Click	Save client properties after edit.
Help		Click	Open online help for the current pane.

Drives

Figure 109 SCSI Client Drives

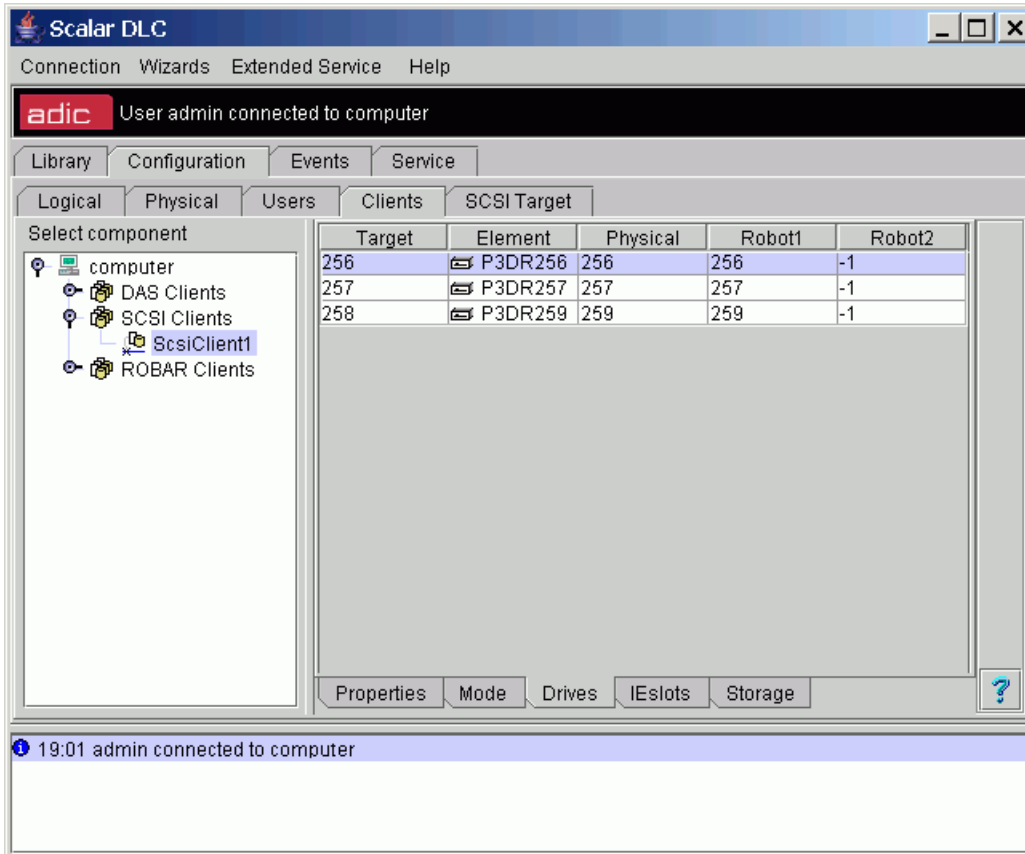

The SCSI Client Drives pane indicates the Drives coordinates as the SCSI client will see them.

Field/Button	Icon	Operation	Description
Target		Supplied	The element coordinate as seen to the client.
Element		Supplied	The element, as shown in the Management GUI.
Physical		Supplied	The element physical coordinate.
Robot1		Supplied	The Robot1 element coordinate. -1 means the element does not belong to Robot1.
Robot2		Supplied	The Robot2 element coordinate. -1 means the element does not belong to Robot2.
Help		Click	Open online help for the current pane.

Refer also to [Drive](#) on page 104.

I/E Slots

Figure 110 SCSI Client I/E Slots

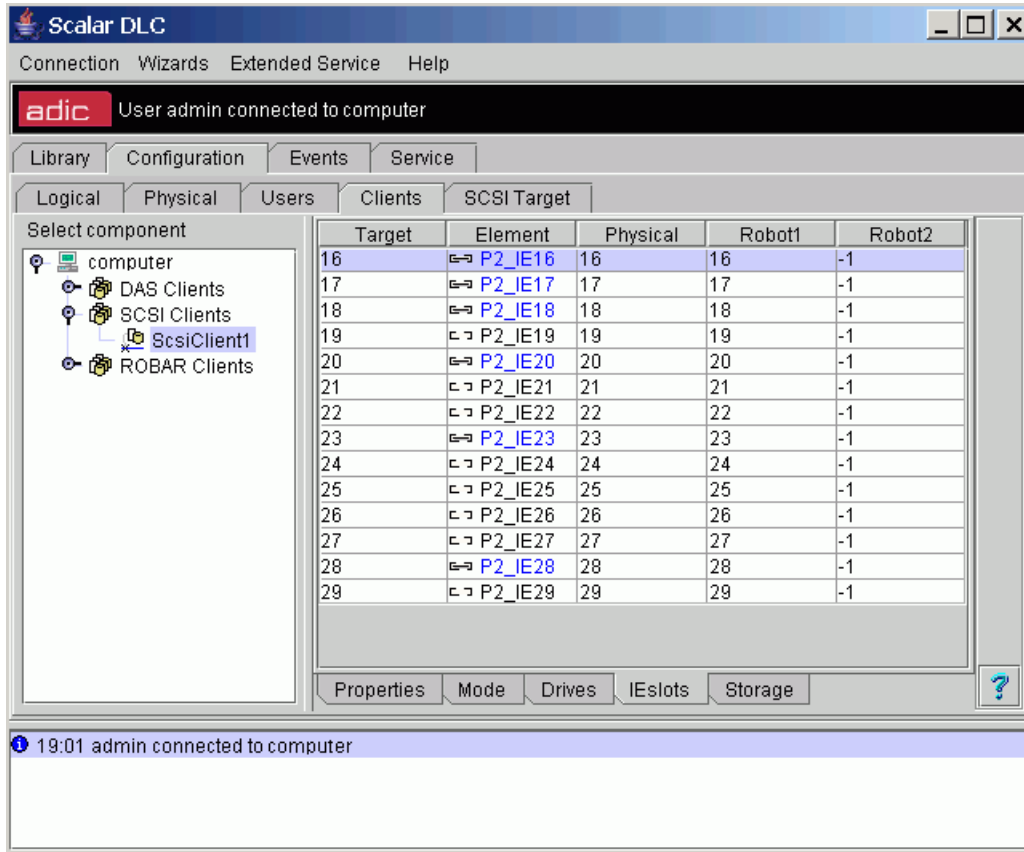

The SCSI Client I/E slots pane indicates the I/E slots coordinates as the SCSI client will see them.

Field/Button	Icon	Operation	Description
Target		Supplied	The element coordinate as seen to the client.
Element		Supplied	The element, as shown in the Management GUI.
Physical		Supplied	The element physical coordinate.
Robot1		Supplied	The Robot1 element coordinate. -1 means the element does not belong to Robot1.
Robot2		Supplied	The Robot2 element coordinate. -1 means the element does not belong to Robot2.
Help		Click	Open online help for the current pane.

Refer also to [Mailbox Slot](#) on page 102.

Storages

Figure 111 SCSI Client Storages

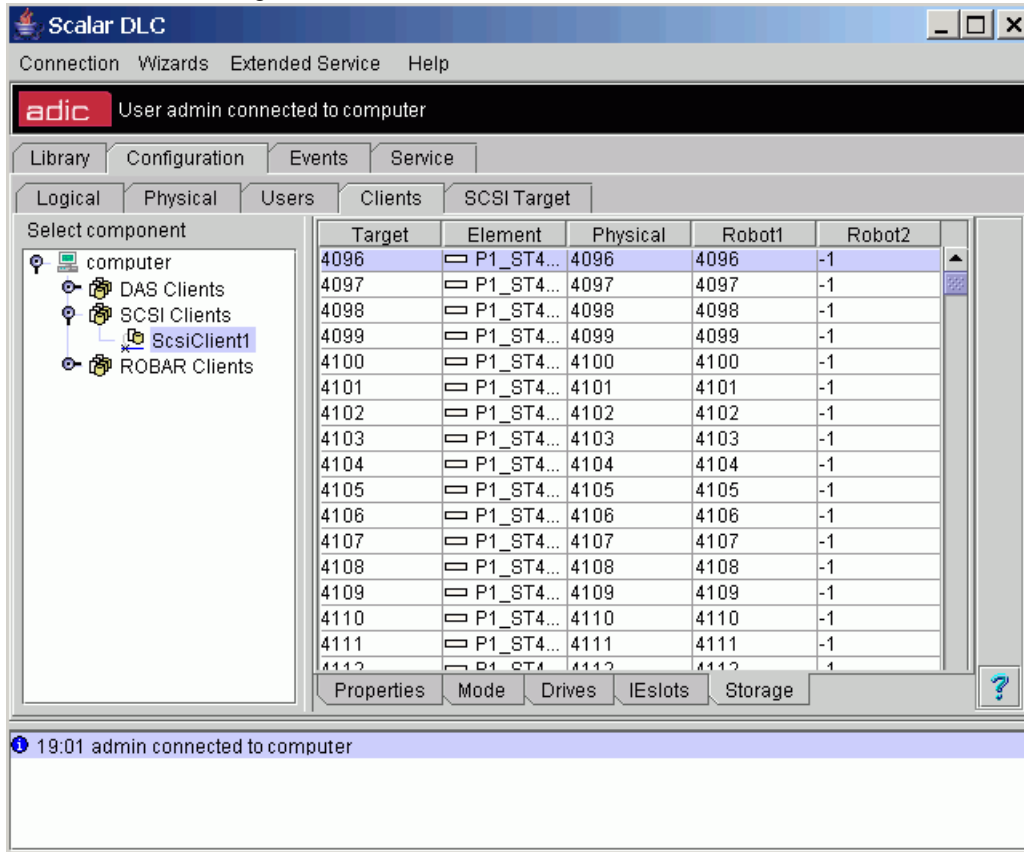

The SCSI Client Storages pane indicates the storage slots coordinates as the SCSI client will see them.

Field/Button	Icon	Operation	Description
Target		Supplied	The element coordinate as seen to the client.
Element		Supplied	The element, as shown in the Management GUI.
Physical		Supplied	The element physical coordinate.
Robot1		Supplied	The Robot1 element coordinate. -1 means the element does not belong to Robot1.
Robot2		Supplied	The Robot2 element coordinate. -1 means the element does not belong to Robot2.
Help		Click	Open online help for the current pane.

Refer also to [Storage Slot](#) on page 101.

Create SCSI Client

Under the SCSI properties, the **Add new Client** button appears. Click it to open pop-up client creation pane.









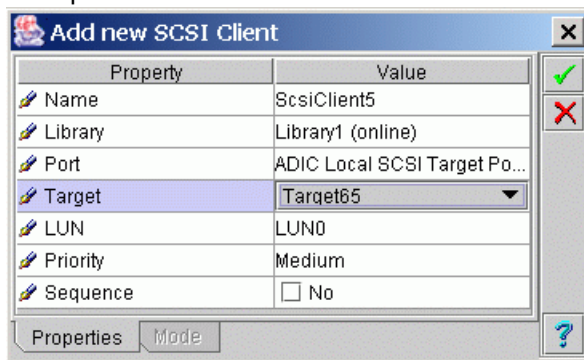

 **Note** Only administrator users can create clients. For the user without administrative privileges, the **Add new Client** button is disabled.

Figure 112 SCSI Client Creation Properties



Field/Button	Icon	Operation	Description
Name		Enter	The client name. Also refer to Table 6 on page 16.
Library		Select	The client operates with the selected logical library.
Port		Select	The client is connected to the SCSI bus via the selected port.
Target		Select	The client is assigned to the selected target.
LUN		Select	The client is assigned to the selected LUN.
Priority		Select	<i>Low</i> means the client-sent commands have the lowest priority in a queue. Refer to Queue Tab on page 174. <i>Medium</i> means the client-sent commands have the standard priority in a queue. Refer to Queue Tab on page 174. <i>High</i> means the client-sent commands have the highest priority in a queue. Refer to Queue Tab on page 174.
Sequence		Do not check	A commands sent by client without sequence option will be executed as they're ready. The system will not wait until the previous client command is finished.
Create		Click	Create client.
Cancel		Click	Cancel creation.
Help		Click	Open online help for the current pane.



Note

The new SCSI Client is functional immediately after creation. No Scalar DLC service restart is required.



Note

Because of interface properties, only one SCSI Client can be assigned to the single LUN.



CAUTION



After the client is assigned to the LUN 0 of any target, all other clients assigned to the non-zero LUNs of this target are activated.

ROBAR

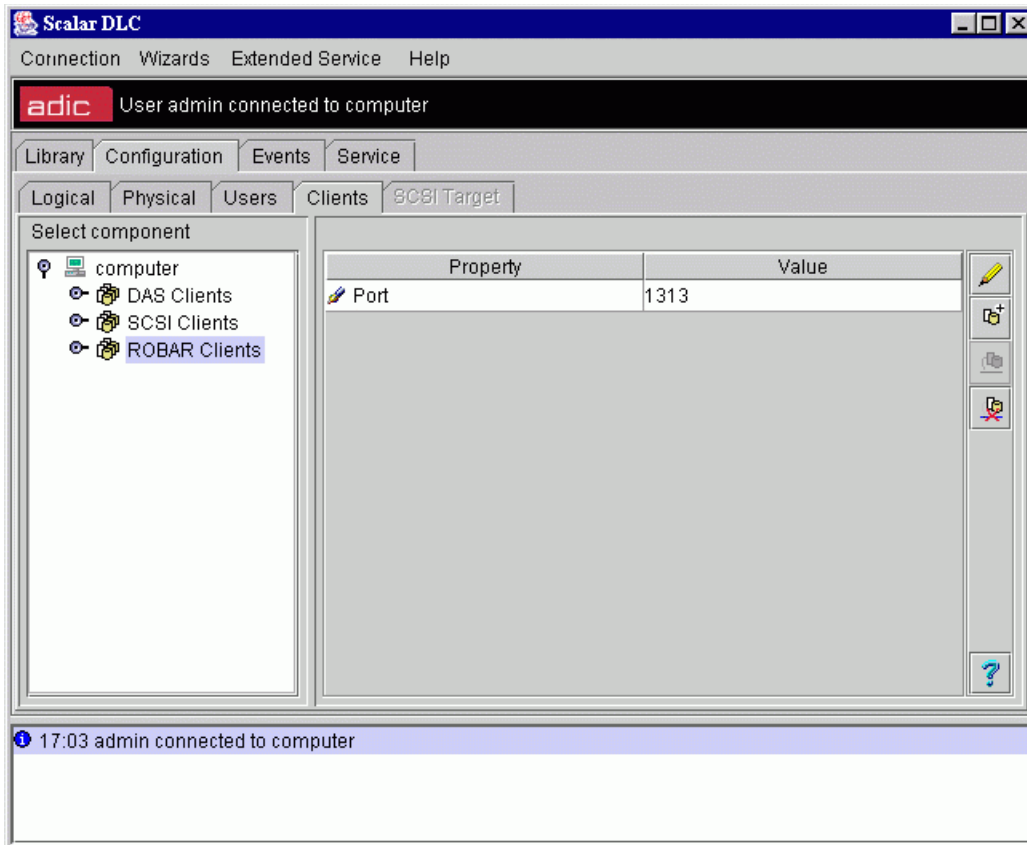
Figure 113 ROBAR Interface Pane



Field/Button	Icon	Operation	Description
Port		Enter	The port to establish the ROBAR client TCP/IP connection(s). Note that the default value of 0 is <u>not</u> valid.
Update		Click	Save port properties after edit.
Add new Client		Click	Pop-up client creation window appears. Refer to Create ROBAR Client on page 160.

Field/Button	Icon	Operation	Description
Enable		Click	Enable ROBAR Interface.
Disable		Click	Disable ROBAR interface. All requests send by ROBAR Clients will receive 'interface disabled' error. Because of ROBAR interface properties, this is the same error as "invalid client", "server stopped", etc.).
Help		Click	Open online help for the current pane.



CAUTION

The ROBAR interface must be valid before the ROBAR client can be created either manually or by the configuration wizard (refer to [Create Configuration](#) on page 32).





Note



Changing the port number applies to all ROBAR clients. The Scalar DLC service restart is required.

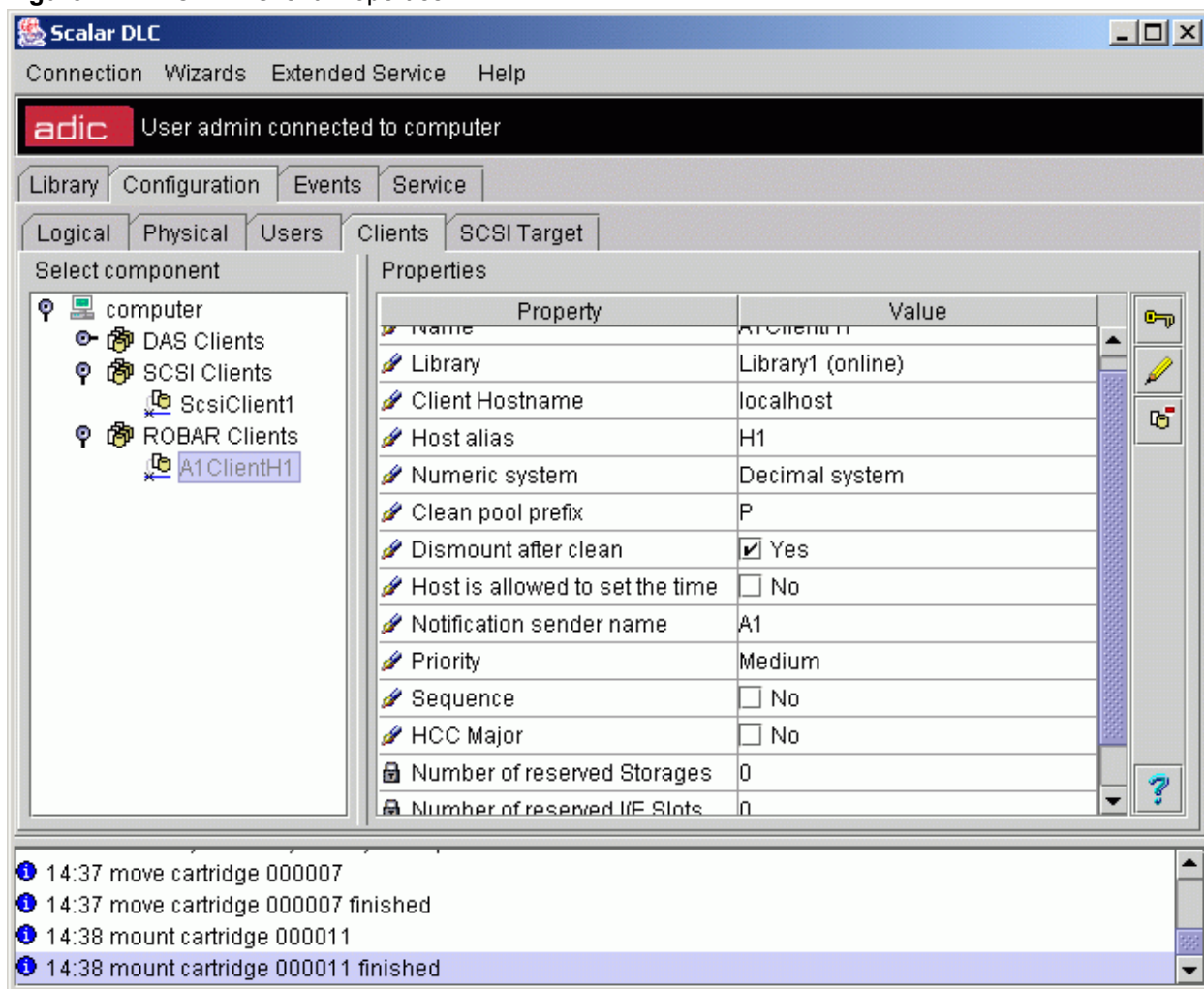













ROBAR Client



Figure 114 ROBAR Client Properties



 **Note** Only administrator users can modify or remove clients. For the user without administrative privileges, the operation buttons are disabled.

Field/Button	Icon	Operation	Description
Name		Enter	Client name. It must not duplicate an existing client name. Also refer to Table 6 on page 16.
Library		Select	The client works with the selected logical library.

Field/Button	Icon	Operation	Description
Client Host Name		Enter	The host name of the computer running the client software. ADIC recommends using the following: <ul style="list-style-type: none"> • client host IP address • client host DNS name, short • client host DNS name, full • <i>localhost</i> for the client operating from local host (possible but not recommended because of security reasons) • <i>any</i> for the client operating from any host (possible but not recommended because of security reasons)
Host alias		Enter	Host alias (ROBAR format).
Numeric system		Select	Numeric system format (decimal/hexadecimal).
Clean pool prefix		Enter	Clean pool prefix used by ROBAR client.
Dismount after clean		Check	Indicates whether the cleaning cartridge should be dismounted after the cleaning ends.
Host is allowed to set the time		Do not check	A client host should not be allowed to set the time.
Notification sender name		Enter	Notification sender (ROBAR format).
Priority		Select	<i>Low</i> means the client-sent commands have the lowest priority in a queue. Refer to Queue Tab on page 174. <i>Medium</i> means the client-sent commands have the standard priority in a queue. Refer to Queue Tab on page 174. <i>High</i> means the client-sent commands have the highest priority in a queue. Refer to Queue Tab on page 174.
Sequence		Do not check	Commands sent by client without sequence option will be executed as they are ready. The system will not wait until the previous client command is finished.
HCC Major		Do not check	Commands send by client without major host parameter cannot be addressed/replied via the HCC/ MVS application.
Number of reserved storages		Supplied	The number of storage slots assigned to the client.
Number of reserved I/E slots		Supplied	The number of mailbox (I/E) slots assigned to the client.
Number of reserved drives		Supplied	The number of drives assigned to the client.
Unreserve All		Click	De-allocates all slots currently allocated for the client (storage, I/E, and drives).

Field/Button	Icon	Operation	Description
Update		Click	Save client properties after edit.
Remove		Click	Remove the client.
Help		Click	Open online help for the current pane.

Create ROBAR Client

Under the ROBAR Interface properties, the **Add new Client** button appears. Clicking it opens a pop-up client creation pane.



 **Note** Only the administrator users can create the clients. For the user without administrative privileges, the create client button is disabled.



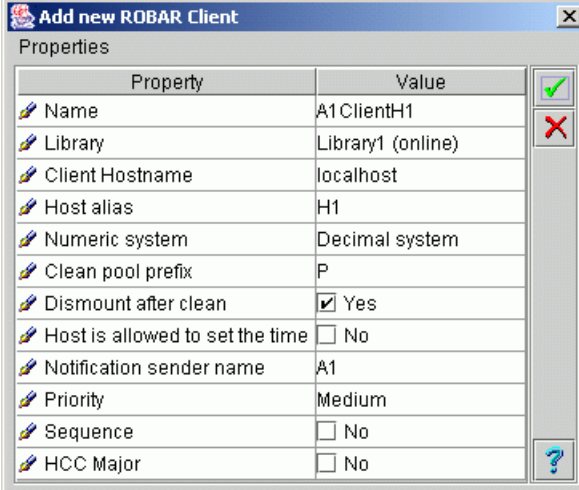









It is recommended that the default name be accepted, but it is not required. Be sure that the name specified manually does not duplicate an existing client name.

Figure 115 ROBAR Client Creation



Property	Value
Name	A1 ClientH1
Library	Library1 (online)
Client Hostname	localhost
Host alias	H1
Numeric system	Decimal system
Clean pool prefix	P
Dismount after clean	<input checked="" type="checkbox"/> Yes
Host is allowed to set the time	<input type="checkbox"/> No
Notification sender name	A1
Priority	Medium
Sequence	<input type="checkbox"/> No
HCC Major	<input type="checkbox"/> No

Field/Button	Icon	Operation	Description
Name		Enter	The client name. It must not duplicate an existing client name. Also refer to Table 6 on page 16.
Library		Select	The client works with the selected logical library.

Field/Button	Icon	Operation	Description
Client Host Name		Enter	The host name of the computer running the client software. ADIC recommends using the following: <ul style="list-style-type: none"> • client host IP address • client host DNS name, short • client host DNS name, full • <i>localhost</i> for the client operating from local host (possible but not recommended because of security reasons) • <i>any</i> for the client operating from any host (possible but not recommended because of security reasons)
Host alias		Enter	Host alias (ROBAR format).
Numeric system		Select	Numeric system format (decimal/hexadecimal).
Clean pool prefix		Enter	Clean pool prefix used by ROBAR client.
Dismount after clean		Check	Indicates whether the cleaning cartridge should be dismounted after the cleaning ends.
Host is allowed to set the time		Do not check	A client host should not be allowed to set the time.
Notification sender name		Enter	Notification sender (ROBAR format).
Priority		Select	<i>Low</i> means the client-sent commands have the lowest priority in a queue. Refer to Queue Tab on page 174. <i>Medium</i> means the client-sent commands have the standard priority in a queue. Refer to Queue Tab on page 174. <i>High</i> means the client-sent commands have the highest priority in a queue. Refer to Queue Tab on page 174.
Sequence		Do not check	Commands sent by client without sequence option will be executed as they're ready. The system will not wait until the previous client command is finished.
HCC Major		Do not check	Commands send by client without major host parameter cannot be addressed/replied via the HCC/ MVS application.
Create		Click	Create client.
Cancel		Click	Cancel creation.
Help		Click	Open online help for the current pane.



Note

The new ROBAR Client is functional immediately after creation. No Scalar DLC service restart is required.

SCSI Target Tab

The SCSI Target tab is designed for the configuration of the Target part of the SCSI interface.

 **Note** This tab is accessible only if the Scalar DLC SCSI Client component is installed.

The SCSI Target is an intermediary between the logical library (configured by the Scalar DLC) and the SCSI. This intermediary requires a configuration that is executed into two steps. First, the SCSI target must be configured. Second, the Scalar DLC SCSI Client(s) must be created and assigned to the appropriate logical libraries. The first step is executed here. The second step is executed via the Clients tab. Refer to [SCSI Client](#) on page 147.

The SCSI client (either a person or a software application) connects to the Scalar DLC via the LUN object that is shown to it as a part of the Target on a SCSI bus. One LUN may contain one client (SCSI Client). The Target always contains LUN 0 and may contain other LUNs; the number is limited by the SCSI HBA properties. All initiators of the SCSI bus may use the LUN configured for that bus. The physical connection is established via the host bus adapter (this hardware is called SCSI Adapter, the model of adapter does not matter if it is supported by the Scalar DLC software). [Table 1](#) on page 6 describes the target adapters the Scalar DLC software currently supports.

The host bus adapter sends and receives commands via the channels called SCSI Ports. Depending on the command stream direction, the ports are operating either in Initiator or Target mode (called Initiator ports or Target ports). The Scalar DLC works with the Target ports only, the initiator mode is not used for the port configured as Target. The configuration of the Target mode for the SCSI Ports is executed via the SCSI Target Port Tool (refer to [SCSI Target Port Tool](#) on page 217).

The Targets and LUNs are created manually. After the LUN is created, a SCSI client can be added as an intermediary between the logical library and the LUN object that represents an initiator of the SCSI bus (it can be either a user or a software application).

Table below shows the icons that represents the SCSI Target tab objects.

Table 22 SCSI Target Icons







Name	Icon	Text Color	Description
Available port		Black	Indicates a SCSI Port (available). The port is functional, and the connection with the initiators can be established.
Not available port		Gray	Indicates a SCSI Port (not available). The port will be functional after enabling, but the connection with the initiators currently cannot be established. The new targets cannot be added but all operations with the existing targets are enabled.
Absent port		Light-gray	Indicates a SCSI Port (not present). The port is not functional. The new targets cannot be added but all operations with the existing targets are enabled.
Active target		Black	Indicates a SCSI Target (active). There is a client configured for this target at LUN 0. The SCSI bus initiators may now work with the target.
Not active target		Gray	Indicates a SCSI Target (not active). The target LUN 0 is ready to accept a SCSI client. The SCSI bus initiators may not work with the target until it will be <i>active</i> .

Table 22 SCSI Target Icons (Continued)

Name	Icon	Text Color	Description
Active LUN		Black	Indicates a LUN (active). The SCSI client is configured to use this LUN.
Not active LUN		Gray	Indicates a LUN (not active). The SCSI client is not configured to use this LUN.

The Target may work either in SCSI-2 or in SCSI-3 mode. All the LUNs of this target will work in this mode, too, and this will be the standard for all clients assigned to these LUNs. For the details refer to the *SCSI Primary Commands 2 (SPC-2)* and *SCSI Primary Commands 3 (SPC-3)* manuals.

Depending on the adapter model and the SCSI operating mode, the number of targets per port and the number of LUN per target are indicated in [Table 23](#).

Table 23 SCSI and Fibre Channel Adapter Target-LUN Settings

Adapter	Type	Max target	Max SCSI ID	Max LUNs per target
LSI 20860	SCSI	7	7	8
LSI 8751D	SCSI	15	15	8
LSI 8951U	SCSI	15	15	8
QLA 2200	Fibre Channel	1	1	256 (8) ^a
QLA 23xx	Fibre Channel	1	1	256 (8)
Local	SCSI	128	128	255 (8)

a. Indicated max LUN number in SCSI-3 (SCSI-2) mode.

Port





In the *Select Components* area of the pane, selectable Ports appear. Clicking the expand/collapse button will result in an element expansion.

 **Note** The SCSI ports cannot be configured by means of the Scalar DLC Management GUI because they are built-in external system objects. The Scalar DLC software can only use them or indicate that the port is not usable.

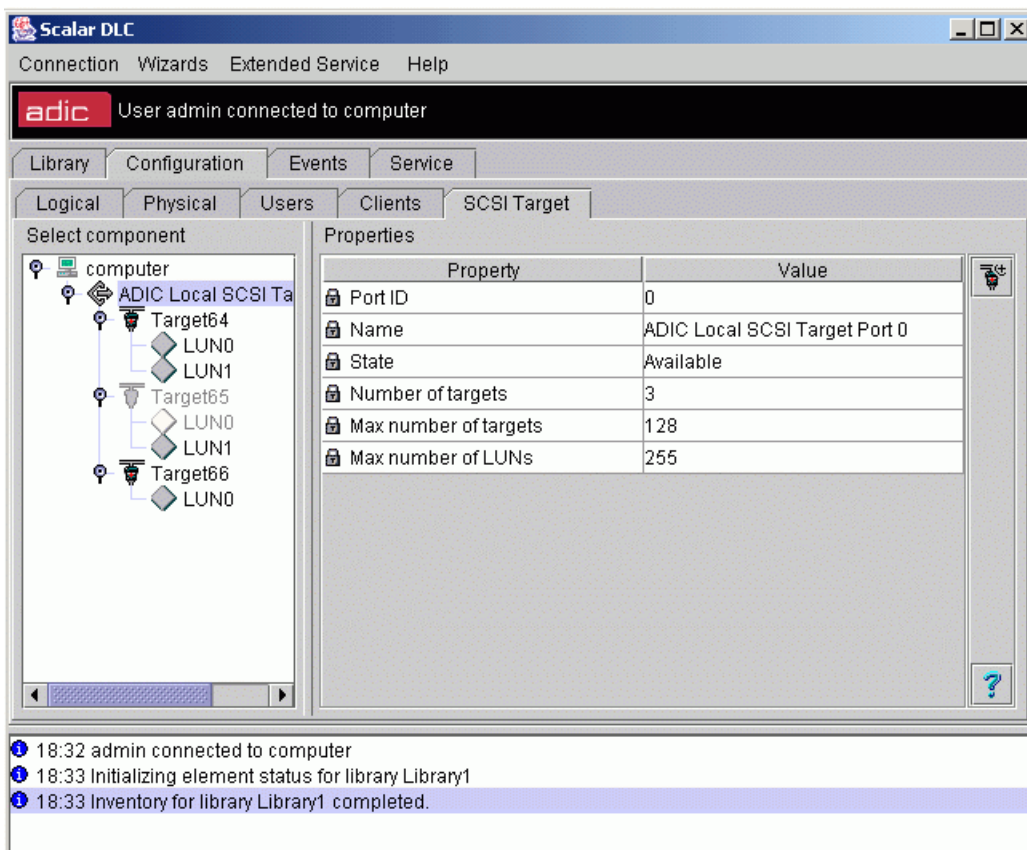
The operation of enable/disable the Port is executed by means of the SCSI Target Port Tool. Refer to [SCSI Target Port Tool](#) on page 217.

Figure 116 Port: SCSI



Field/Button	Icon	Operation	Description
Port ID		Supplied	The port ID.
Name		Supplied	The port unique name.
State		Supplied	The port state. See Table 22 on page 162.
Number of targets		Supplied	The number of targets currently configured for the SCSI port.
Max number of targets		Supplied	The maximum number of targets that can be configured for the SCSI port. Refer to Table 23 on page 163.





Field/Button	Icon	Operation	Description
Max number of LUNs		Supplied	The maximum number of LUNs that can be configured for the targets of the SCSI port. Refer to Table 23 on page 163.
World wide name		Supplied	(only for the Fibre Channel) The world wide port name, hexadecimal.
Add new Target		Click	Pop-up target creation window appears. Refer to Create Target on page 169.
Help		Click	Open online help for the current pane.

Figure 117 Port: Fibre Channel



Target

In the *Select Components* area of the pane, selectable Targets appear.

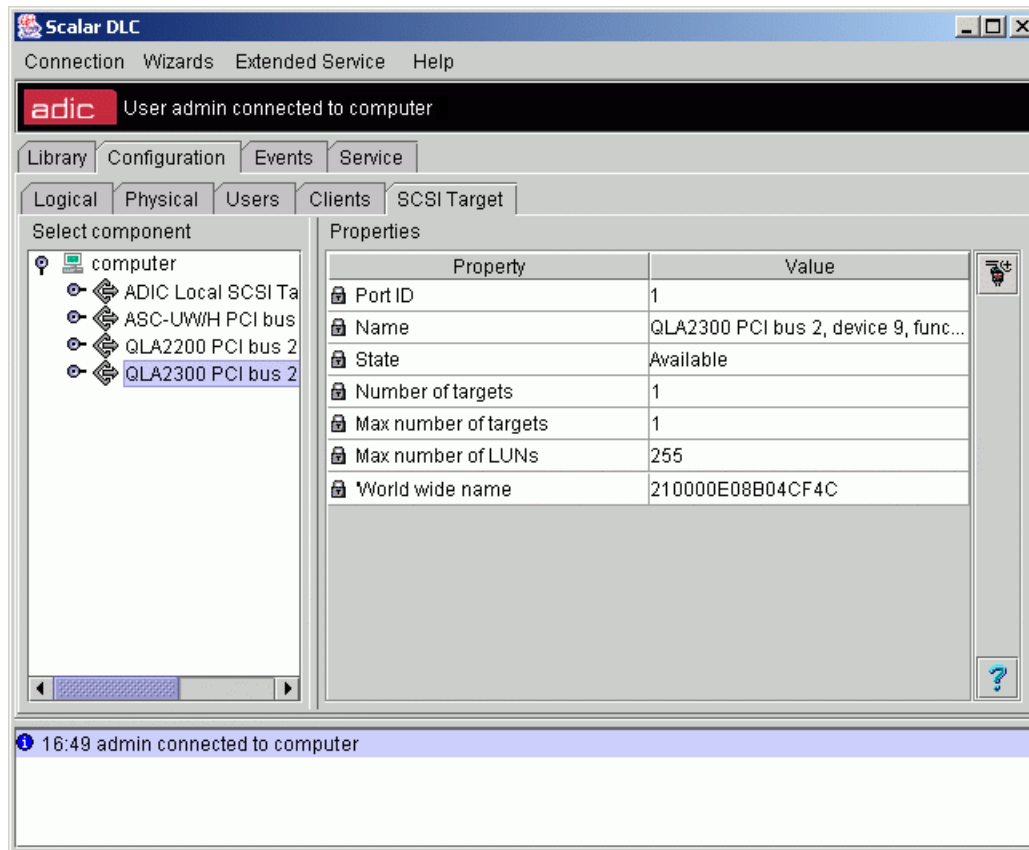
Figure 118 SCSI Target

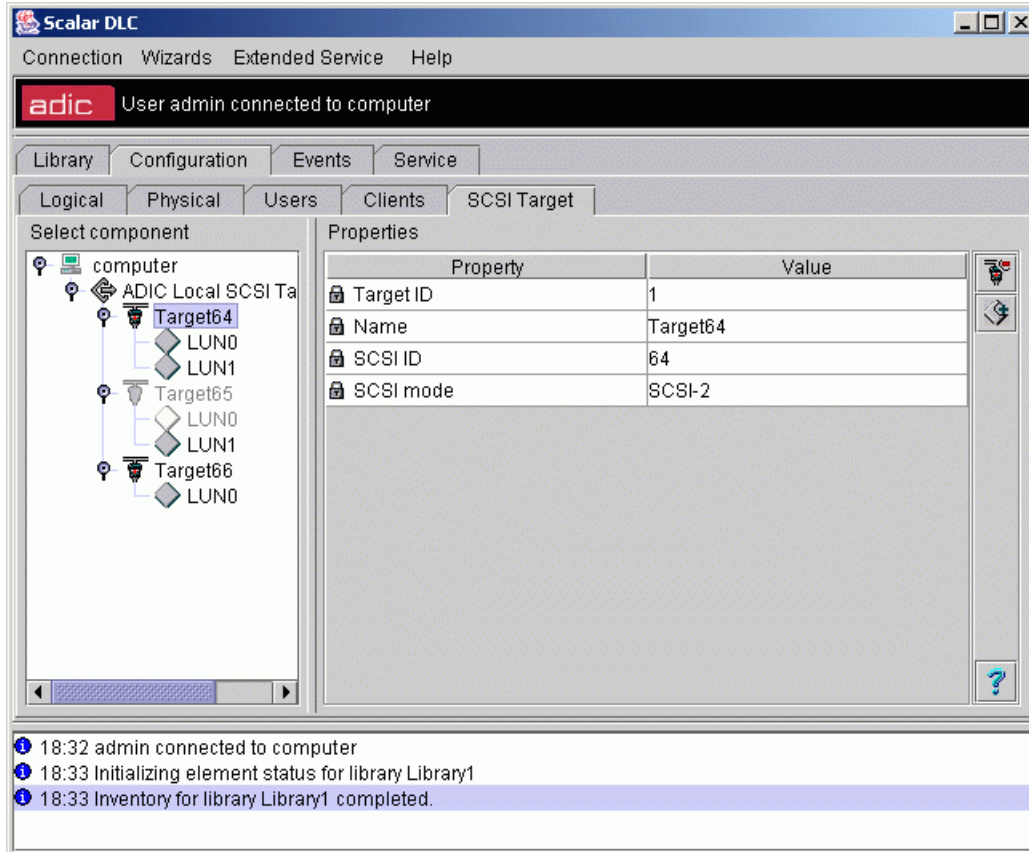

Field/Button	Icon	Operation	Description
Target ID		Supplied	The target ID (internal).
Name		Supplied	The target name. Contains 'Target' and the SCSI ID.
SCSI ID		Supplied	The target SCSI ID (external, seen by SCSI initiator).
SCSI Mode		Supplied	The target operating mode. Only <i>SCSI-2</i> and <i>SCSI-3</i> are currently supported. Also refer to Table 23 on page 163
Add new LUN		Click	Pop-up LUN creation window appears. Refer to Create LUN on page 170.
Remove		Click	Remove the SCSI Target.
Help		Click	Open online help for the current pane.

The *not active* Target becomes *active* after a client (SCSI Client) assigned to the LUN 0 of this target. Refer to [SCSI Client](#) on page 147.

For the details of the SCSI command format, refer to:

- *SCSI Reference Manual* for the Scalar 10K library.
- *SCSI Reference Manual* for the Scalar 1000 library.



Note

The newly created target already contains LUN 0. If the other LUNs are required, they should be created manually.



CAUTION

When the SCSI Target is removed, all SCSI Clients configured for LUNs of this target are removed as well.

The Target can operate either in SCSI-2 or in SCSI-3 mode. All the LUNs of this target will work in this mode as well, and this will be the standard for all clients assigned to these LUNs. For the details of the SCSI Mode refer to:

- *SCSI Primary Commands 2 (SPC-2) Manual*
- *SCSI Primary Commands 3 (SPC-3) Manual*



Note

Because of interface properties, one and only one SCSI Client can be assigned to the single LUN.



CAUTION

After the client is assigned to the LUN 0 of any target, all other clients assigned to the non-zero LUNs of this target are activated.

Logical Unit Number (LUN)

Figure 119 SCSI LUN

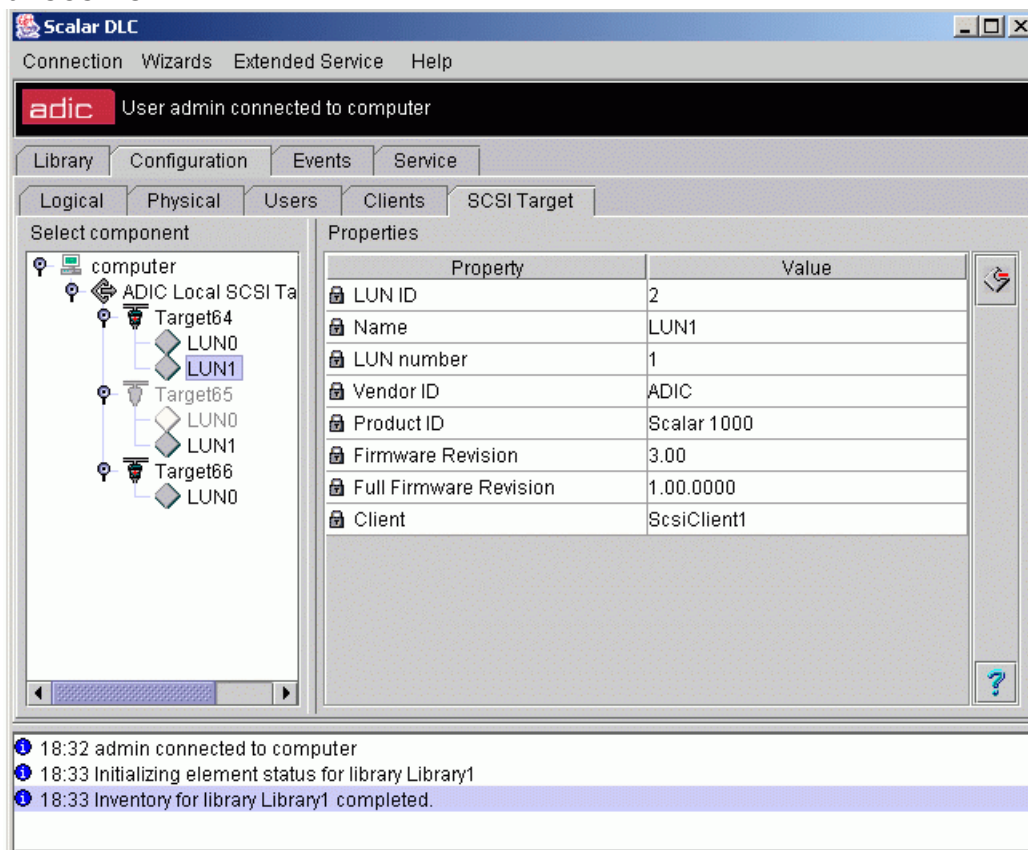

Field/Button	Icon	Operation	Description
LUN ID		Supplied	LUN ID (internal).
Name		Supplied	LUN name. Contains 'LUN' + LUN Number.
LUN Number		Supplied	LUN SCSI ID (external, seen by SCSI initiator).
Vendor ID		Supplied	Vendor ID, as will be seen by the SCSI Initiator.
Product ID		Supplied	Product ID. The format of the data transferred from/to the SCSI initiator.
Firmware revision		Supplied	The firmware revision level, short form.
Full firmware revision		Supplied	The firmware revision level, complete.
Client		Supplied	The assigned SCSI Client (for the active LUN only).
Remove		Click	Remove the LUN.
Help		Click	Open online help for the current pane.

 **Note** The LUN 0 cannot be removed manually. It is deleted only with the Target.

The *not active* LUN becomes *active* after a client (SCSI Client) assigned to it. Refer to [SCSI Client](#) on page 147.

 **Note** Because of interface properties, one and only one SCSI Client can be assigned to the single LUN.

 **CAUTION** **After the client is assigned to the LUN 0 of any target, all other clients assigned to the non-zero LUNs of this target are activated.**

Create Target

Under the SCSI Port properties, the **Add new Target** button appears (active for the *enabled* ports only). Clicking it opens a pop-up target creation pane.











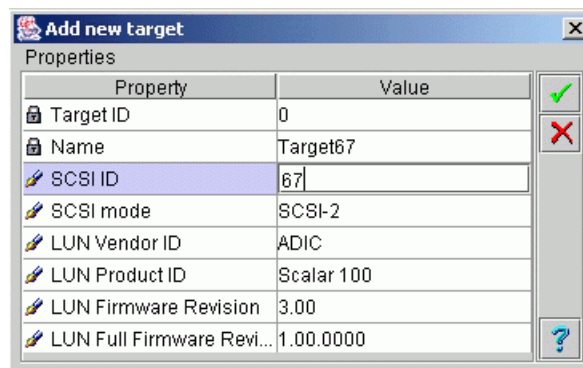

 **Note** Only administrator users can create targets. For the user without administrative privileges, the **Add new Target** button is disabled.

Figure 120 SCSI Target Creation



Property	Value
Target ID	0
Name	Target67
SCSI ID	67
SCSI mode	SCSI-2
LUN Vendor ID	ADIC
LUN Product ID	Scalar 100
LUN Firmware Revision	3.00
LUN Full Firmware Revision	1.00.0000

Field/Button	Icon	Operation	Description
Target ID		Supplied	The target ID (internal).
Name		Supplied	The target name. Contains 'Target' and the SCSI ID.
SCSI ID		Enter	The target SCSI ID (external, seen by SCSI initiator).
SCSI Mode		Select	The target operating mode. Only <i>SCSI-2</i> and <i>SCSI-3</i> are currently supported.
LUN Vendor ID		Select	Current target LUN 0 vendor ID.
LUN Product ID		Select	Current target LUN 0 product ID. The format of the data transferred from/to the SCSI initiator.

Field/Button	Icon	Operation	Description
LUN Firmware revision		Enter	Current target LUN 0 firmware revision level, short form.
LUN Full Firmware revision		Enter	Current target LUN 0 firmware revision level, complete.
Create		Click	Create SCSI target
Cancel		Click	Cancel creation.
Help		Click	Open online help for the current pane.



CAUTION

The target creation is not possible if the port already contains the maximum number of targets.



Note

The newly created target will *not* be active until there is a SCSI client assigned to the LUN 0 of that target.



Note

The newly created target already contains LUN 0. If other LUNs are required they should be created manually

Create LUN

Under the SCSI Target properties, the **Add new LUN** button is displayed. Clicking it opens a pop-up target creation pane.









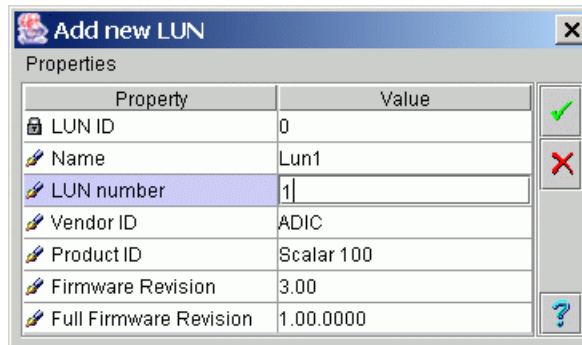



Note

Only administrator users can create LUNs. For the user without administrative privileges, the **Add new LUN** button is disabled.

Figure 121 SCSI LUN Creation



Field/Button	Icon	Operation	Description
LUN ID		Supplied	LUN ID (internal).
Name		Enter	LUN name. Contains 'LUN' + LUN Number.
LUN Number		Enter	The LUN SCSI ID (external, seen by SCSI initiator).
Vendor ID		Select	Vendor ID, as will be seen by the SCSI Initiator.
Product ID		Select	Product ID. The format of the data transferred from/to the SCSI initiator:
Firmware Revision		Enter	The firmware revision level, short form.
Full Firmware Revision		Enter	The firmware revision level, complete.
Create		Click	Create SCSI LUN
Cancel		Click	Cancel creation.
Help		Click	Open online help for the current pane.



CAUTION

The LUN creation is not possible if the target already contains the maximum number of LUNs.



Note

The newly created LUN will *not* be active until there is a SCSI client assigned to this LUN. Moreover, the LUN requires the target to be active, and the target becomes *active* only when the SCSI client is assigned to the LUN 0.

7

Events Tab

The Events Tab is designed for viewing event notifications or modifying rules that govern event reporting. The Events Tab contains an additional level with the following tabs:

- Queue Tab. Managing command queue. Refer to [Queue Tab](#) on page 174.
- Monitoring Tab. Monitoring the current login session events. Refer to [Monitoring Tab](#) on page 176.
- Acknowledge Tab. Acknowledging the notifications. Refer to [Acknowledge Tab](#) on page 178.
- History Tab. Monitoring the events during all sessions. Refer to [History Tab](#) on page 179.
- Rules Tab. Managing the rules. Refer to [Rules Tab](#) on page 179.



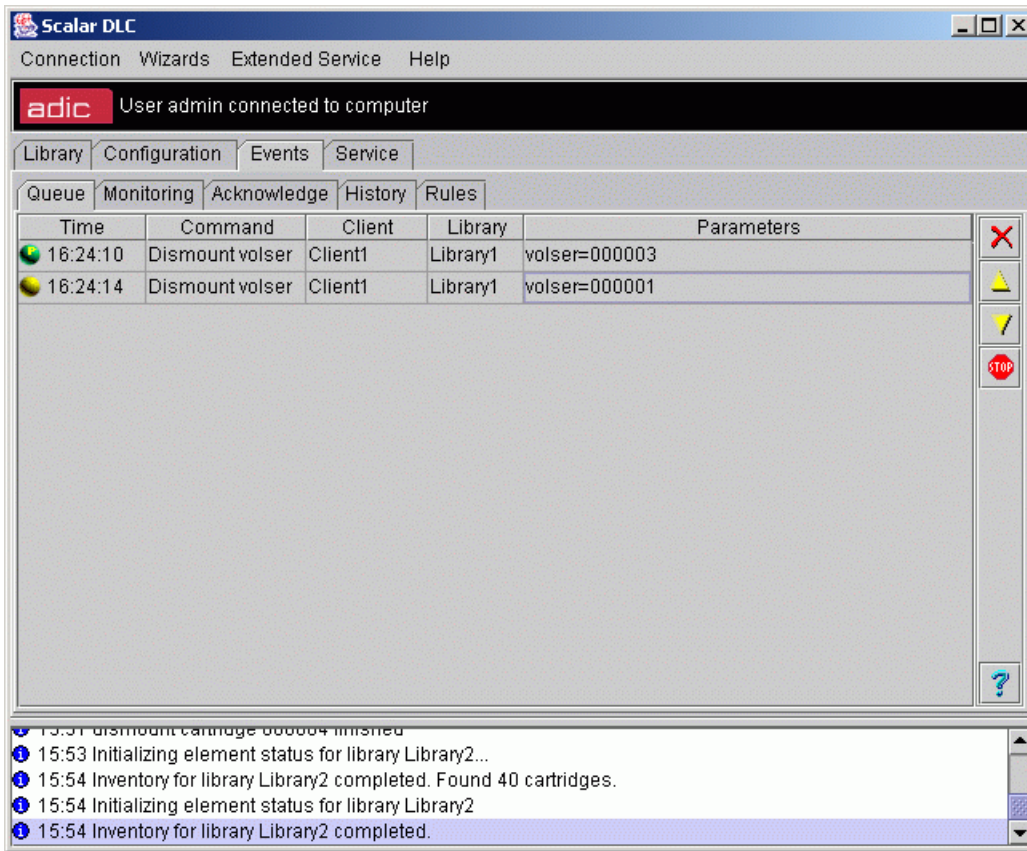

Queue Tab







Figure 122 Queue Tab



The Queue Tab shows the queue of commands currently accepted and executed by the Scalar DLC software. Typically these commands are sent by client backup applications.

 **Note** This tab is accessible for all users. The operation buttons are active for the Admin only.

Field/Button	Icon	Operation	Description
Time		Select	The current command arriving/execution time (HH:MM:SS format). A command status is indicated here (see below).
Running/Preparing		Select	The command is running or preparing to be executed.
Pending		Select	The command is pending the required resources.
Waiting, normal		Select	The command is waiting, its priority is normal.
Waiting, high		Select	The command is waiting, its priority has been raised.

Field/Button	Icon	Operation	Description
Waiting, low		Select	The command is waiting, its priority has been lowered.
Idle		Select	The command is idle (stopped).
Command		Select	The current command.
Client		Select	The client who send a command.
Library		Select	The logical library where the command is executed.
Parameters		Select	The command operating parameters.
Cancel		Click	Cancel command execution and remove command from list.
Raise priority		Click	Raise waiting command priority.
Lower priority		Click	Lower waiting command priority.
Stop		Click	Stop command execution. The command remains idle.
Help		Click	Open online help for the current pane.

Monitoring Tab

Figure 123 Monitoring Tab

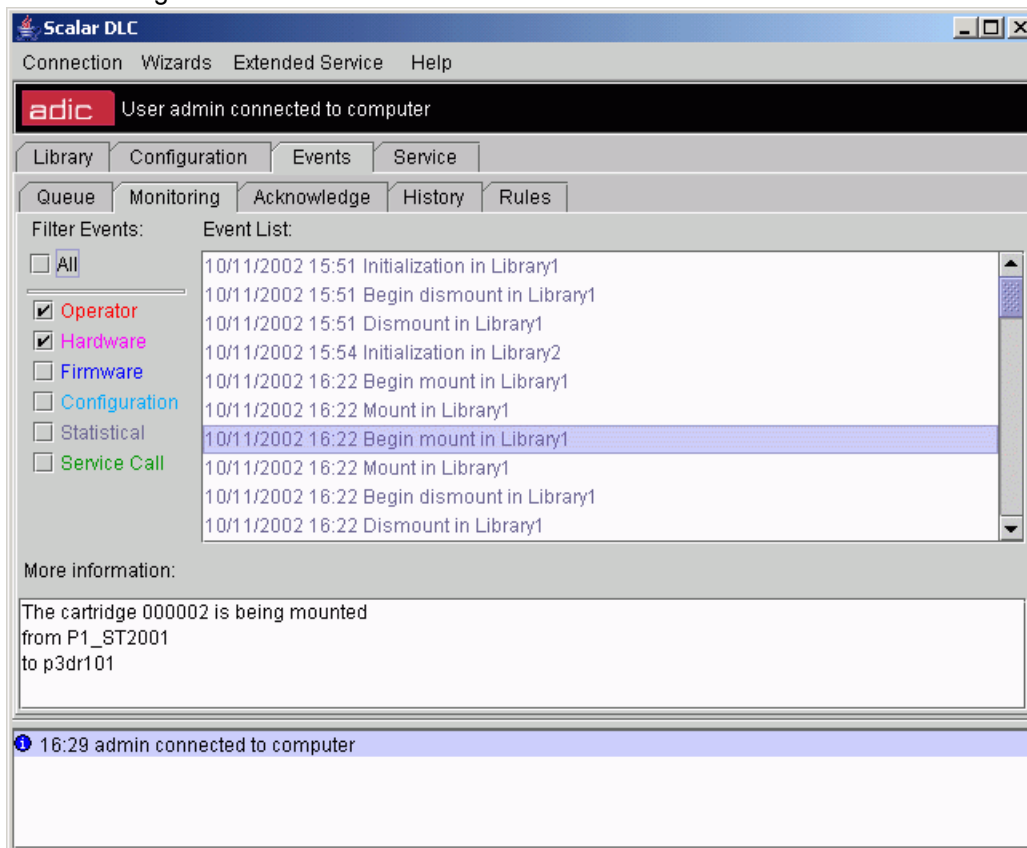

The Monitoring Tab pane describes notifications that it receives during the current login session.

In the *Filter Events* area of the pane, there are seven predefined event classes. Each event class is shown in a different color. See [Table 24](#).

Table 24 Event Classes

Event Class	Color	Checked	Description
All	Black	Yes	All received notifications are displayed.
		No	Only checked notifications are displayed.
Operator	Red	Yes	Operator notifications are displayed.
		No	Operator notifications are not displayed.
Hardware	Pink	Yes	Hardware notifications are displayed.
		No	Hardware notifications are not displayed.
Firmware	Blue	Yes	Firmware notifications are displayed.
		No	Firmware notifications are not displayed.
Configuration	Turquoise	Yes	Configuration notifications are displayed.
		No	Configuration notifications are not displayed.

Table 24 Event Classes (Continued)

Event Class	Color	Checked	Description
Statistical	Dark Blue	Yes	Statistical notifications are displayed.
		No	Statistical notifications are not displayed.
Service Call	Green	Yes	Service Call notifications are displayed.
		No	Service Call notifications are not displayed.

In the *Event List* area of the pane, every event is detailed in a series of single rows. The description of the event is copied from the internal table of events. See [Table 25](#). The event information for the current login session is updated automatically, but the information is lost after the Scalar DLC Management GUI is closed.

Table 25 Event Data

Event	Description
Date	This is the date of the event in the MM/DD/YYYY format.
Time	This is the time of the event in the HH:MM format.
Event	This is the event notification data.

In the *More Information* area of the pane, additional information about the current session is listed. If the *Event List* area cannot contain the complete message, the entire message appears in the *More Information* area.

Acknowledge Tab

Figure 124 Acknowledge Tab

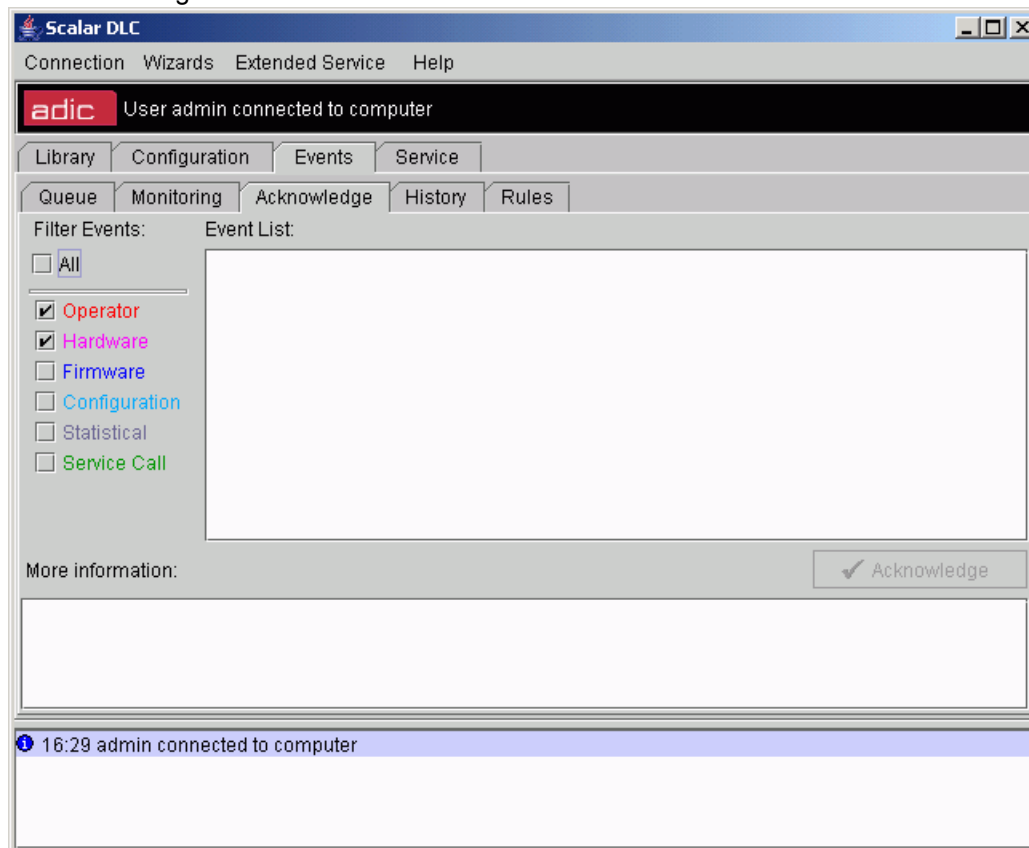

The Acknowledge Tab pane describes the notifications received during current login sessions that require a user acknowledgement.

If the **Acknowledge** button is clicked after an event is selected from the *Event List*, the event is acknowledged by the Scalar DLC software. If a rule associated with the event specifies a service ticket, the Scalar DLC software service generates the service ticket. Refer to [ATAC Calls Tab](#) on page 189 for the description of procedures associated with ticket generation.

In the *Filter Events* area of the pane, there are seven predefined event classes. Each class of event is shown in a different color (see [Table 24](#) on page 176).

In the *Event List* area of the pane, every event is detailed in a series of single rows. The description of the event is copied from the internal table of events. The event information is updated automatically. See [Table 25](#) on page 177.

In the *More Information* area of the pane, additional information about the current session is listed. If the *Event List* area cannot contain the complete message, the entire message appears in the *More Information* area.

History Tab

Figure 125 History Tab

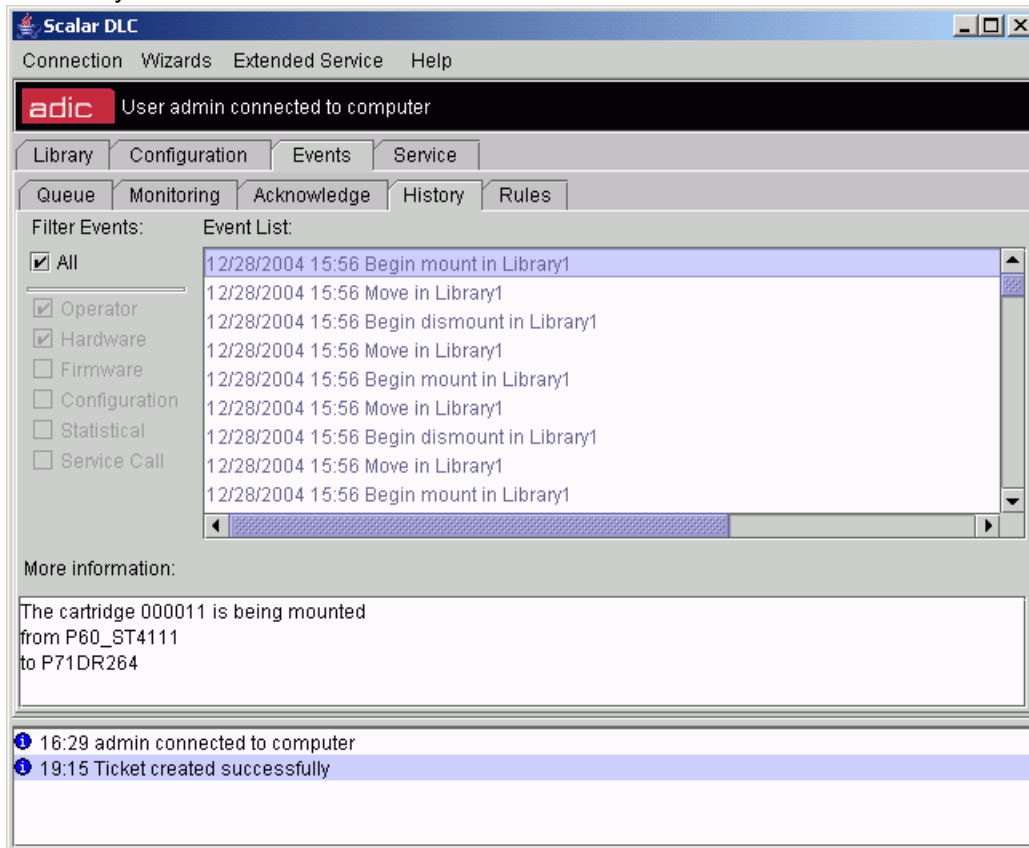

The History Tab pane contains the last 200 notifications that were received during all login sessions.

In the *Filter Events* area of the pane, there are seven predefined event classes. Each class of event is shown in a different color (see [Table 24](#) on page 176).

In the *Event List* area of the pane, every event is detailed in a series of single rows. The description of the event is copied from the internal table of events. The event information is updated automatically. See [Table 25](#) on page 177.

In the *More Information* area of the pane, additional information about the current session is listed. If the *Event List* area cannot contain the complete message, the entire message appears in the *More Information* area.

Rules Tab

The Rules pane displays the list of both pre-defined and user-created rules along with their properties.

 **Note** This section is available only for the users with the rules management rights.





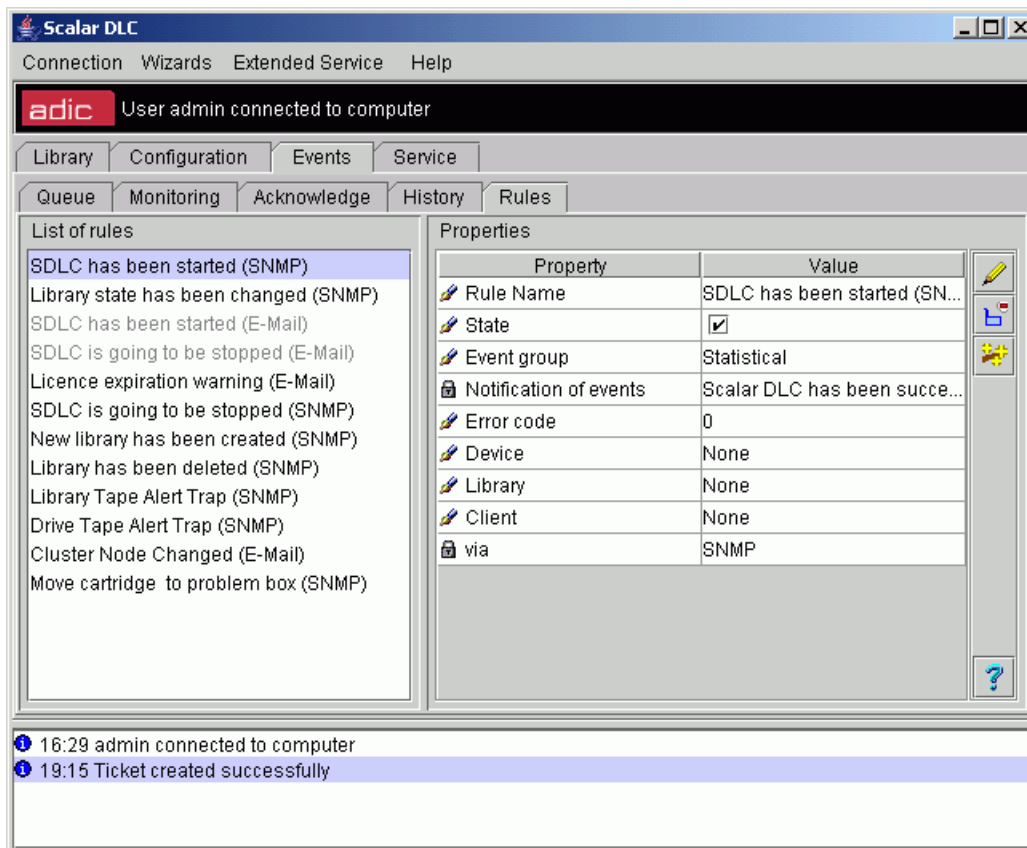

The rules are used to act when a specific event occurs. The actions include simple notification of event, notification of events that require acknowledgment, and service call ticket generation.

It is also possible to launch the wizard-based process for adding user-defined rules. Refer to [Create Rule](#) on page 45.

Figure 126 Rules Tab



Field/Button	Icon	Operation	Description
Rule Name		Enter	Rule name.
State		Check	Whether the rule is active.
Event group		Select	The event group. See Table 8 on page 45.
Notification of events		Select	The event to notify. See Table 8 on page 45.
Error code		Select	Error code. Refer to Error Codes on page 251 and Table 8 on page 45.
Device		Select	Physical library. See Table 8 on page 45.
Library		Select	Logical library. See Table 8 on page 45.
Client		Select	Client. See Table 8 on page 45.
via		Supplied	The method of sending notifications: Email, SNMP, or GUI. The notification method can not be changed.
Email Destination		Select	The notification email destination (<i>email</i> only).
Email Template		Select	The notification email template (<i>email</i> only).

Field/Button	Icon	Operation	Description
User		Select	The user who should acknowledge the notification (<i>GUI</i> only).
Generate ticket		Check	Whether a ticket should be generated after acknowledge (<i>GUI</i> only).
Update		Click	Save the rule properties after edit.
Remove		Click	Remove the rule.
Wizard		Click	Launch the Rule wizard. Refer to Create Rule on page 45.
Help		Click	Open online help for the current pane.

 Note The rules configured to send email notifications cannot be activated when the *Email Notifications* field in the Registration Info pane is not checked. Refer to [Registration Information](#) on page 55.

 Note The rules configured to send SNMP notifications cannot be activated when the SNMP service is not started. Refer to [SNMP Tab](#) on page 199.

8

Service Tab

The Service Tab is designed for the Customer Engineer (CE) and Admin users. The Service Tab has an additional level with the following tabs:

- **Logs Tab.** Monitoring the library command log and error log. Refer to [Logs Tab](#) on page 183.
- **Diagnostic Tab.** Executing the library diagnostics. Refer to [Diagnostic Tab](#) on page 187.
- **ATAC Calls Tab.** Managing the service requests (tickets). Refer to [ATAC Calls Tab](#) on page 189.
- **Operator Panel Tab.** Executing operator panel commands from a remote console. Refer to [Operator Panel Tab](#) on page 195.
- **Cluster Tab.** Viewing and changing the cluster settings. Refer to [Cluster Tab](#) on page 198.
- **SNMP Tab.** Managing the SNMP service settings. Refer to [SNMP Tab](#) on page 199.

Logs Tab

This pane allows the user to view the error log and the command history for the selected robot of the physical library. When a specific event is selected, the information that has been collected can be sent to a specified email address.

This section provides an additional level with the following tabs:

- **Command Log.** The commands executed by the physical library. Refer to [Command Log](#) on page 184.
- **Error Log.** The errors occurred in the physical library. Refer to [Error Log](#) on page 186.



Note The Command Log and Error Log features are not available for the Scalar 1000 library.





Note The Scalar 10K DA library has two robots, so it contains two different Command logs and Error logs.

Command Log

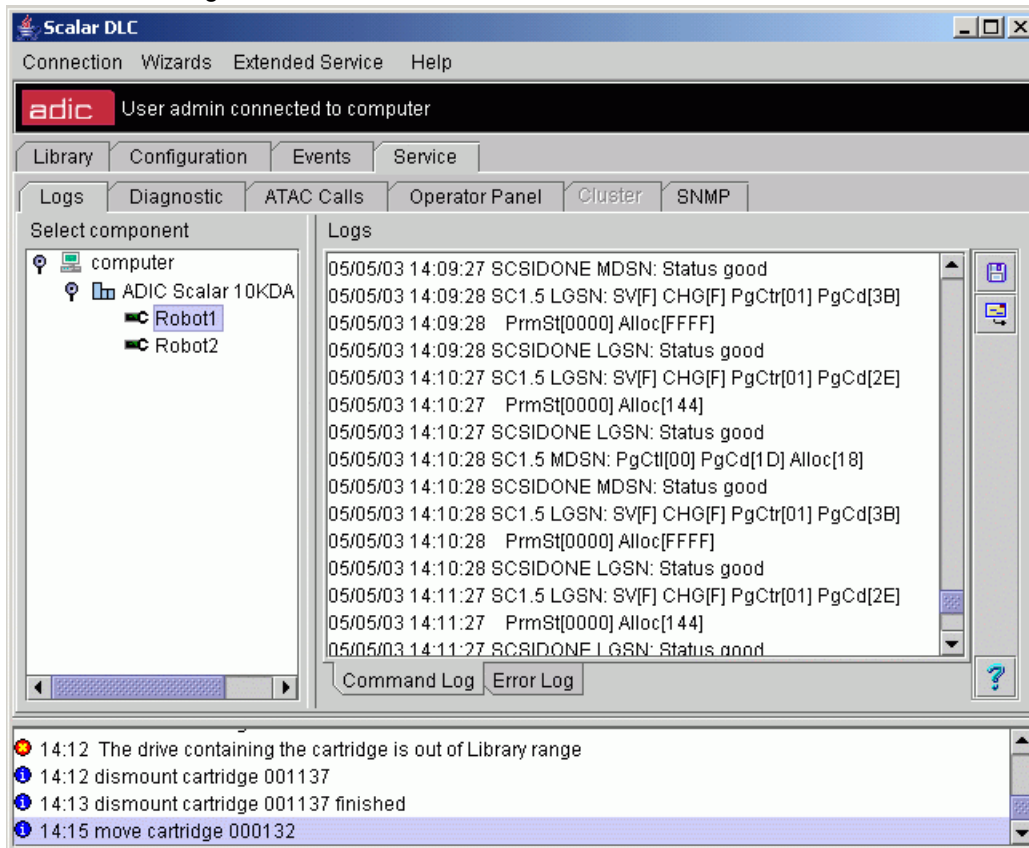
Figure 127 Command Log





Button	Icon	Operation	Description
Save to file		Click	Save log to file.
Send email		Click	Send the log via email. Refer to Send Log via Email on page 185.
Help		Click	Open online help for the current pane.

Send Log via Email

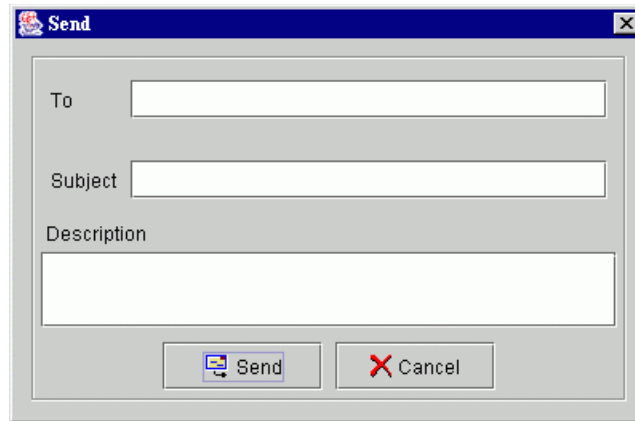
Figure 128 Email Data



Field/Button	Icon	Operation	Description
To		Enter	The recipient email address associated with the data. Multiple email addresses must be separated with semicolons.
Subject		Enter	The subject of the email.
Description		Enter	The email message text (the data will be attached in a separate file).
Send		Click	Send the email to the recipient.
Cancel		Click	Close the Email dialog without sending email.







Note

The email will be sent successfully only if the email parameters of the current user are valid. Refer to [User](#) on page 131 for the details on the user's email parameters.

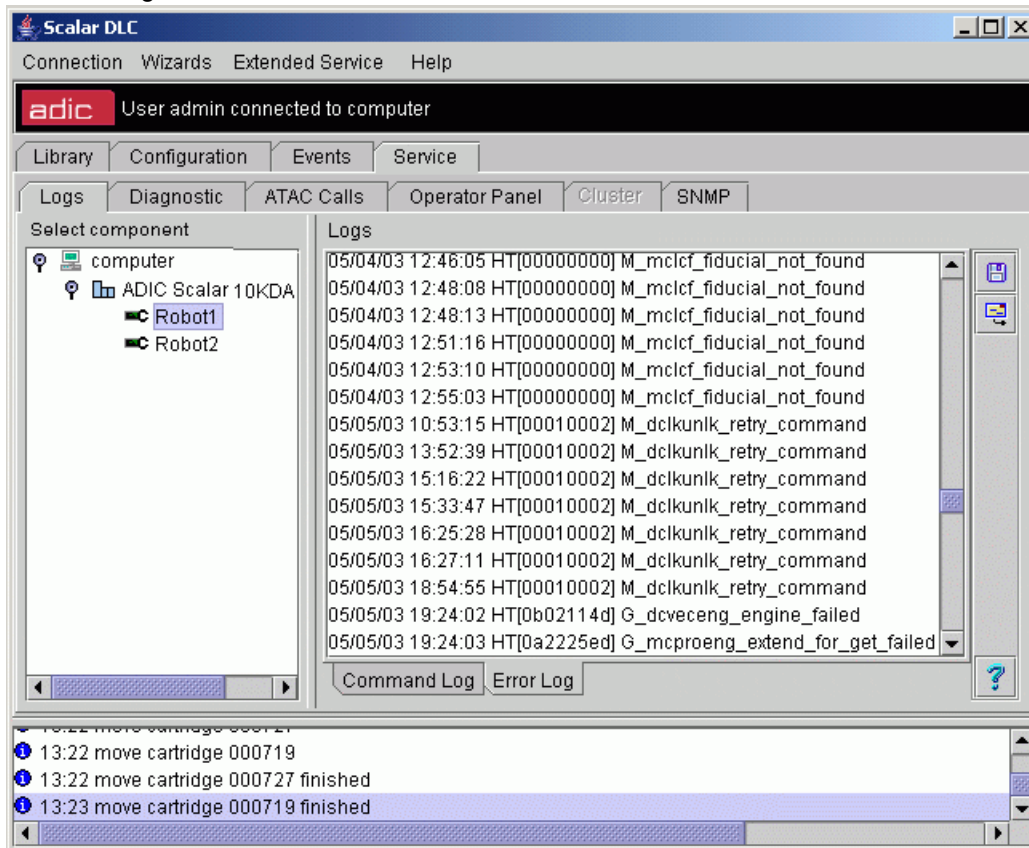
Error Log

Figure 129 Error Log



Button	Icon	Operation	Description
Save to file		Click	Save log to file.
Send email		Click	Send the log via email. Refer to Send Log via Email on page 185.
Help		Click	Open online help for the current pane.

Diagnostic Tab

Figure 130 Diagnostic Tab

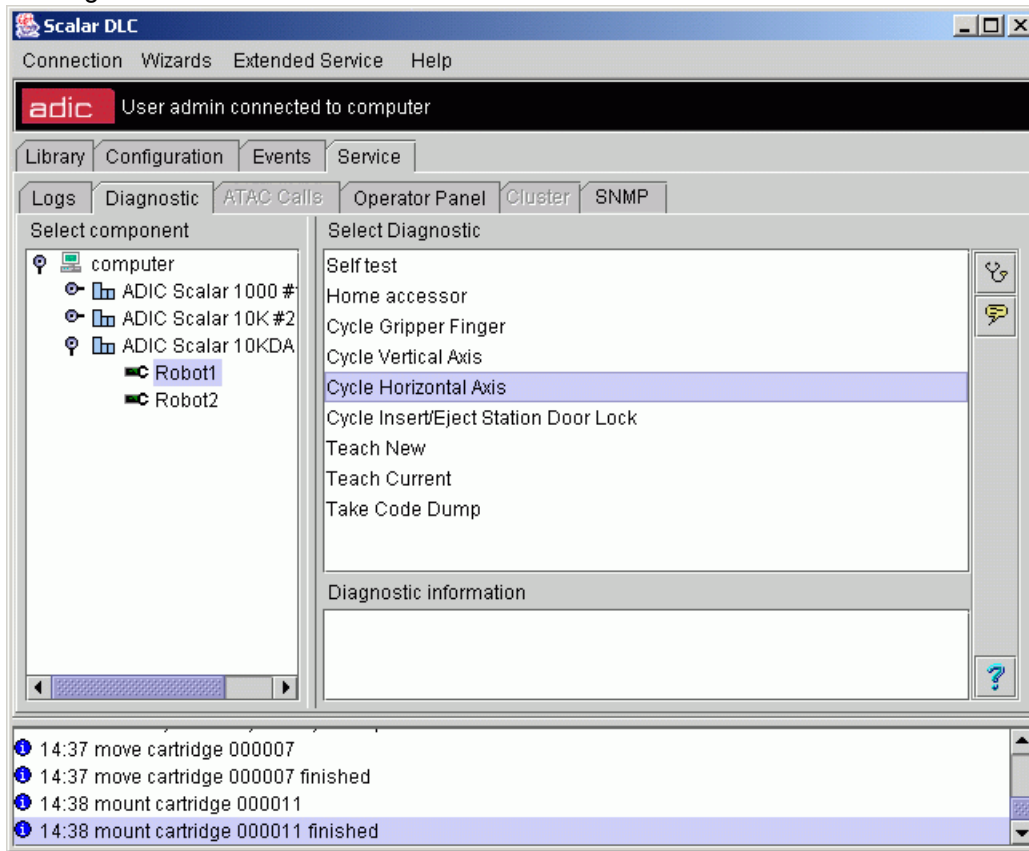

This Diagnostic pane specifies diagnostic tests that can be executed on a robot.

Select the diagnostic test and click on **Execute** button to launch it.

The result of the diagnostic test appears in the *Diagnostic Information* area on the right.





Field/Button	Icon	Operation	Description
Select Diagnostic		Select	<p><i>Self test</i> is the complete test included in all of the steps described in the following text.</p> <p><i>Home Accessor</i> moves the accessor to the home position on the vertical and horizontal axes.</p> <p><i>Cycle Gripper Finger</i> opens and closes the gripper fingers.</p> <p><i>Cycle Vertical Axis</i> moves the accessor to the home position on the vertical axis, then to the top of the vertical axis, and returns it to the home position.</p> <p><i>Cycle Horizontal Axis</i> moves the accessor to the home position on the horizontal axis, then to the far right of the horizontal axis, and returns it to the home position.</p> <p><i>Cycle Insert/Eject Station Door Lock</i> locks and then unlocks the Insert/Eject solenoid.</p> <p><i>Teach New</i> reteaches the library configuration.</p> <p><i>Teach Current</i> reteaches the library current configuration.</p> <p><i>Take Code Dump</i> saves the current state of code execution in DRAM.</p>
Diagnostic information		Supplied	The results of the diagnostic test.
Execute		Click	Execute the selected diagnostic test.
Description		Click	Show the selected diagnostic test description. See Figure 131 on page 188.
Help		Click	Open online help for the current pane.

Figure 131 Diagnostic Description

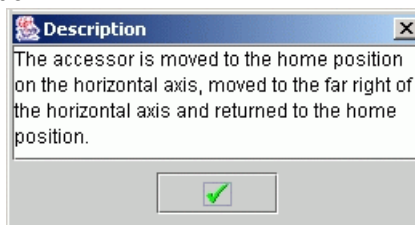

ATAC Calls Tab

The ATAC Calls tab shows the list of report issues (tickets) either created by the customer or generated automatically.

 **Note** This tab is accessible only by Customer Engineers (CE) and the users with the ticket management rights. All CEs are a part of the ADIC Technical Assistance Center (ATAC).

Selecting the ATAC Calls Tab pane is the first step to solving a problem. A written description of the problem is shown under the ticket properties.

Tickets can be generated manually by the customer or automatically by a notification rule.

The customer creates tickets with the help of the Ticket wizard launched from the Management GUI main menu. Refer to [Create Ticket](#) on page 40.

Figure 132 ATAC Calls Tab

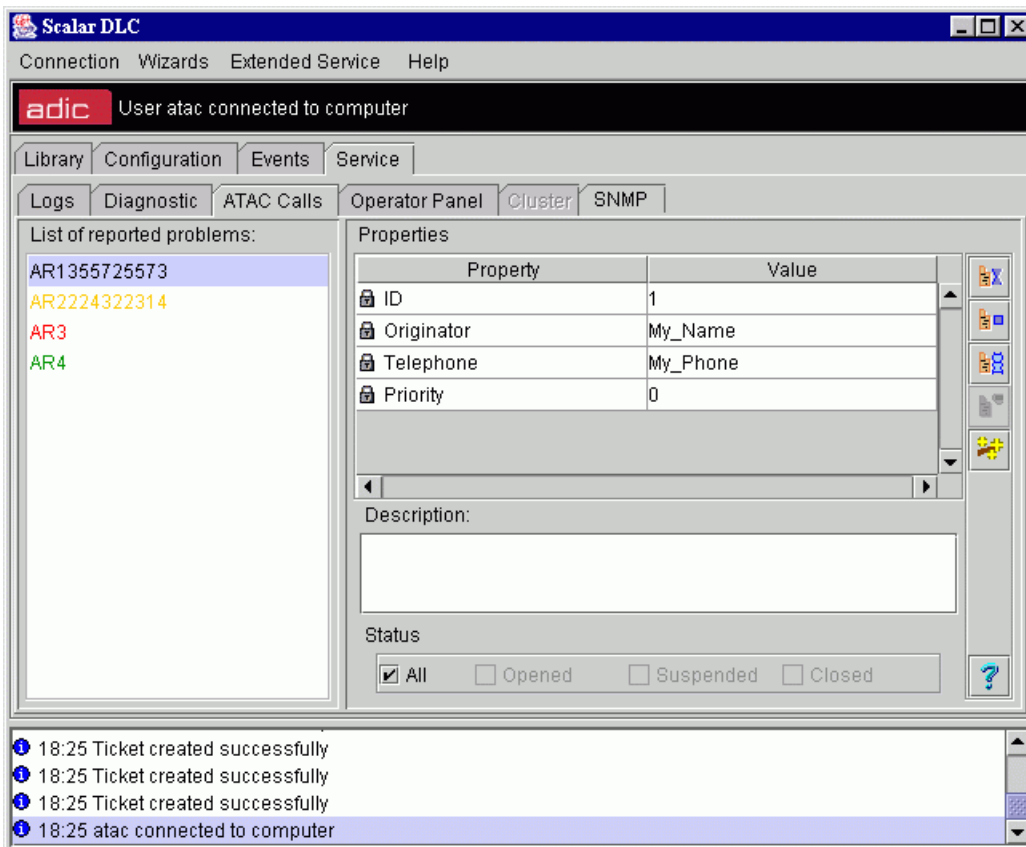

In the *List of reported problems* area of the pane, all of the reported problems are listed. The ticket reports are color-coded for identification.

List	Color	Description
Open	Red	This color indicates an opened problem. The CE has not start working under the issue.
Suspended	Black	This color indicates a solved problem but the ticket has not been closed.

List	Color	Description
In Process	Yellow	This color indicates that a CE is working on the problem.
Closed	Green	This color indicates a solved problem, and the ticket has been closed.

In the *Properties* area of the pane, the ticket properties are shown for the selected problem report.











Field/Button	Icon	Operation	Description
ID		Supplied	The ticket ID (generated by the Scalar DLC software or applied manually by the CE).
Originator		Supplied	The ticket originator.
Telephone		Supplied	The originator's phone number.
Priority		Supplied	The problem priority selected by the originator.
Description		Supplied	The brief description of the problem entered by the originator.
Status, All problems		Check	Display all problems.
Status, Opened		Check	Display all opened problems.
Status, Suspended		Check	Display all suspended problems.
Status, Closed		Check	Display all closed problems.
Start Repair		Click	Display the Start Repair dialog (for the <i>opened</i> tickets only). See Figure 133 on page 191.
Under Repair		Click	Display the Repair dialog (for the <i>suspended</i> or <i>in process</i> tickets only). See Figure 134 on page 192.
Close		Click	Close ticket (for the <i>opened</i> or <i>suspended</i> tickets only).
History		Click	Display the History pane. See Figure 137 on page 194.
Remove		Click	Remove ticket (for the <i>closed</i> tickets only).
Wizard		Click	Launch the Ticket wizard. Refer to Create Ticket on page 40.
Help		Click	Open online help for the current pane.

Figure 133 Start Repair

Field/Button	Icon	Operation	Description
CE Name		Enter	The CE name. It indicates a person assigned by ATAC as responsible for solving a problem.
Start Time		Supplied	The start time of the repair.
Service Code		Select	<p><i>Do not know</i> means the CE cannot make a problem determination based on the service ticket information.</p> <p><i>Unscheduled Repair</i> means an unexpected repair is required.</p> <p><i>Scheduled Repair</i> means a pre-arranged time has been allocated for the repair.</p> <p><i>Information Call</i> means information is being sent to ATAC.</p> <p><i>Customer Resp.</i> means the problem is caused or belongs to the customer.</p> <p><i>Preventive Maint.</i> means routine preventive maintenance is scheduled.</p> <p><i>Installation</i> means the ticket is generated to notify ATAC about the installation of the system.</p> <p><i>De-Installation</i> means the ticket is generated to notify ATAC about a system de-installation.</p> <p><i>EC/Field Bill</i> means a service call is the result of an EC/Field build installation.</p> <p><i>Feature Code Change</i> means a new feature or function is added to the system.</p>
Ticker AR		Enter	The AR registration number supplied by ATAC support.
Start Time		Supplied	The time when the CE start the work.
OK		Click	Accept entered information.
Cancel		Click	Return to the ATAC Calls pane, changes discarded.

Figure 134 Repair

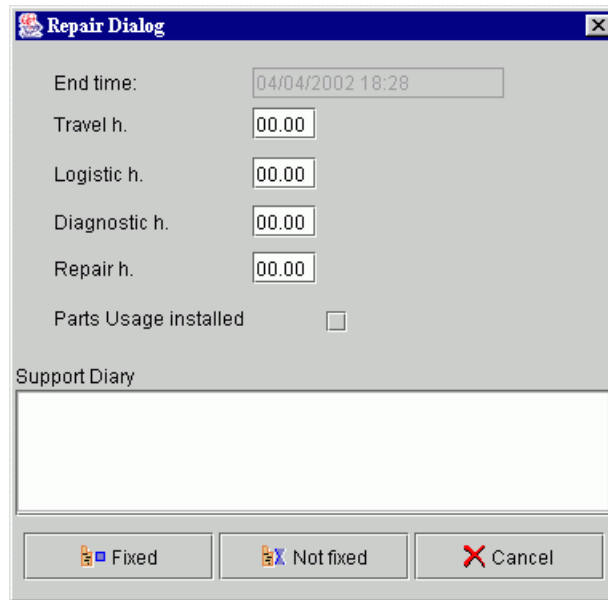

Field/Button	Icon	Operation	Description
End Time		Supplied	The time repair ended.
Travel h.		Enter	The time required to travel to the customer site.
Logistics h.		Enter	The time for administrative functions associated with the repair. Parts ordering is an example of the logistics associated with a repair.
Diagnostic h.		Enter	The time it took to diagnose the problem.
Repair h.		Enter	The time necessary to repair the problem.
Parts Usage Installed		Check	Total repair parts usage.
Support Diary		Enter	Comments about the repair process.
Fixed		Click	The problem is fixed. See Figure 135 on page 193.
Not fixed		Click	The problem is not fixed. See Figure 136 on page 193.
Cancel		Click	Return to the ATAC Calls pane, changes discarded.

Figure 135 Fixed Problem Confirmation

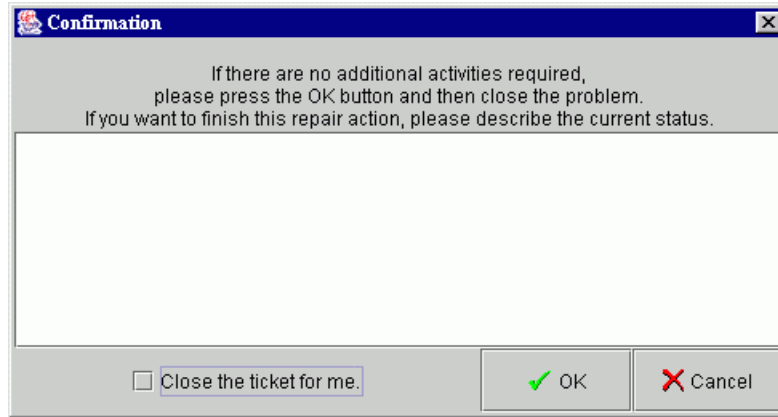

Field/Button	Icon	Operation	Description
Current Status		Enter	A description of the current problem status.
OK	✓	Click	Return to the ATAC Calls pane. The ticket can be closed.
Cancel	✗	Click	Return to the Repair dialog.
Close the ticket for me	<input type="checkbox"/>	Check	The Scalar DLC software closes the problem ticket automatically.

Figure 136 Not Fixed Problem Confirmation

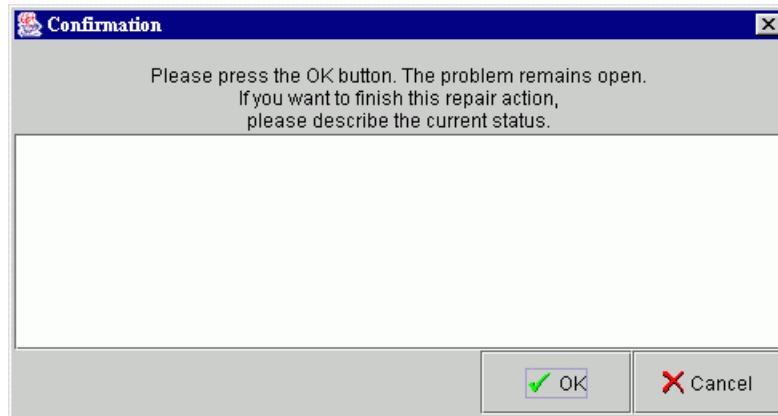

Field/Button	Icon	Operation	Description
Current Status		Enter	A description of the current problem status.
OK	✓	Click	Return to the ATAC Calls pane. The ticket will be <i>In process</i> .
Cancel	✗	Click	Return to the Repair dialog.

The Repair History dialog lists the events associated with a specific repair.

Figure 137 Repair History

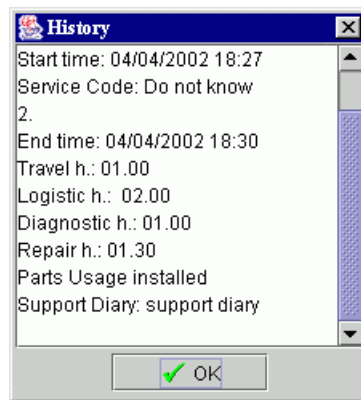

Field/Button	Icon	Operation	Description
Ticket ID		Supplied	The ticket identifier generated by the Scalar DLC software service.
CE Name		Supplied	The ticket originator identification.
Start Time		Supplied	The start time of the repair service.
Service Code		Supplied	<p><i>Do not know</i> means the CE cannot make a problem determination based on the service ticket information.</p> <p><i>Unscheduled Repair</i> means an unexpected repair is required.</p> <p><i>Scheduled Repair</i> means a pre-arranged time has been allocated for the repair.</p> <p><i>Information Call</i> means information is being sent to ATAC.</p> <p><i>Customer Resp.</i> means the problem is caused or belongs to the customer.</p> <p><i>Preventive Maint.</i> means routine preventive maintenance is scheduled.</p> <p><i>Installation</i> means the ticket is generated to notify ATAC about the installation of the system.</p> <p><i>De-Installation</i> means the ticket is generated to notify ATAC about a system de-installation.</p> <p><i>EC/Field Bill</i> means a service call is the result of an EC/Field build installation.</p> <p><i>Feature Code Change</i> means a new feature or function is added to the system.</p>
Ticket AR		Supplied	The AR registration number supplied by ATAC support.
End Time		Supplied	The Scalar DLC software service supplies the end time.
Travel h.		Supplied	The travel time for arriving at the customer location.

Field/Button	Icon	Operation	Description
Logistics h.		Supplied	The time for administrative functions associated with the repair. Parts ordering is an example of the logistics associated with the repair.
Diagnostic h.		Supplied	The time to diagnose the problem.
Repair h.		Supplied	The time necessary to repair the problem.
Parts Usage Installed		Supplied	The total repair parts.
Support Diary		Supplied	Comments about the repair process.
OK		Click	Return to the ATAC Calls pane.

Operator Panel Tab

This tab mimics the operator panel on the actual device and provides an interactive path between the operator and the library indicators and push-buttons that control the library.









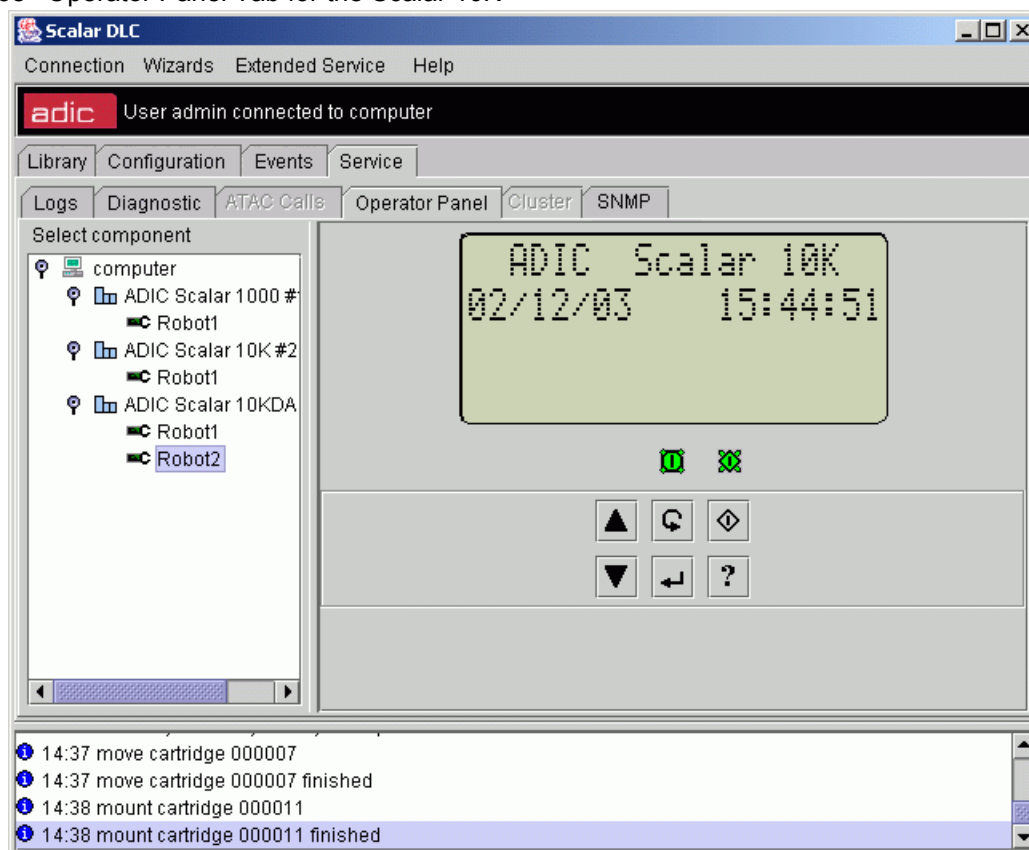

 **Note** The Scalar 10K DA library has two different robots and respectively two different operator panels.

Figure 138 Operator Panel Tab for the Scalar 10K



Item	Description
LCD Screen	The vendor ID, library type, date, and time are shown on the operator LCD screen. The operations with push-buttons are indicated here, too.
	The Locked indicator is lit whenever the I/E station is locked (only for Scalar 1000 libraries).
	The Power On indicator is lit whenever the Control Module is connected to the power source, the Control Module switch, and the AC Power Compartment(s) circuit breakers are ON.
	The Ready indicator is lit whenever Power is available in the aisle and the library is ready to perform motion commands from the host.
	<p>The Up Arrow push button:</p> <ul style="list-style-type: none"> • scrolls the display to show previous line(s). • moves the cursor (>) up from selection to selection. • increases the current value to the next value when used in an entry field.
	<p>The Down Arrow push button:</p> <ul style="list-style-type: none"> • scrolls the display to show the next line(s). • moves the cursor (>) down from selection to selection. • decreases the current value to the previous value when used in an entry field.
	<p>The Escape push button:</p> <ul style="list-style-type: none"> • leaves the current display and returns to the previous display, if it exists. • moves from the Initial Screen to the Main Menu.
	<p>The Enter push button:</p> <ul style="list-style-type: none"> • selects the current option as the next action to be performed by the library, the cursor (>) indicates the chosen option. • acts as a TAB button to the next required entry field when multiple field entries are being entered. In this case, the button cycles through all the entry locations until the Accept option is chosen (with Y).
	<p>The Ready push button:</p> <ul style="list-style-type: none"> • transitions the library from a Ready state to Not Ready or Not Ready to the Ready state.
	<p>The Help push button:</p> <ul style="list-style-type: none"> • displays help text for the current selected item if available. In this mode, the Arrow buttons scroll through the help text, and the Escape button is used to exit the help display.

 **WARNING**

LOOK INTO THE AISLE TO MAKE SURE THERE ARE NO OBSTRUCTIONS OR PERSONNEL PRESENT PRIOR TO APPLYING LIBRARY POWER. MOVEMENTS OF MECHANICAL COMPONENTS IN THE LIBRARY CAN CAUSE SERIOUS INJURY.



Note

Refer to *Scalar 1000 Operator Guide* and *Scalar 10K Operator Guide* for detailed description of LCD Operator Screen

Figure 139 Operator Panel Tab for the Scalar 1000

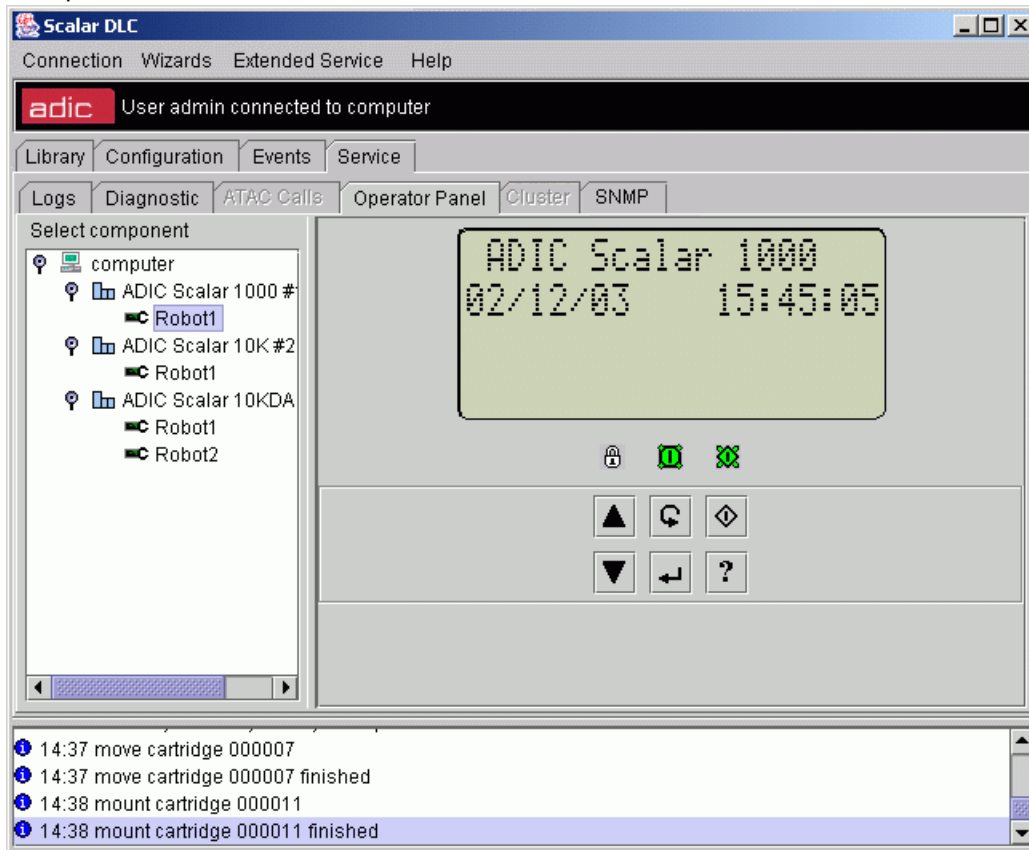

Cluster Tab





The Cluster tab shows current Scalar DLC Cluster settings.

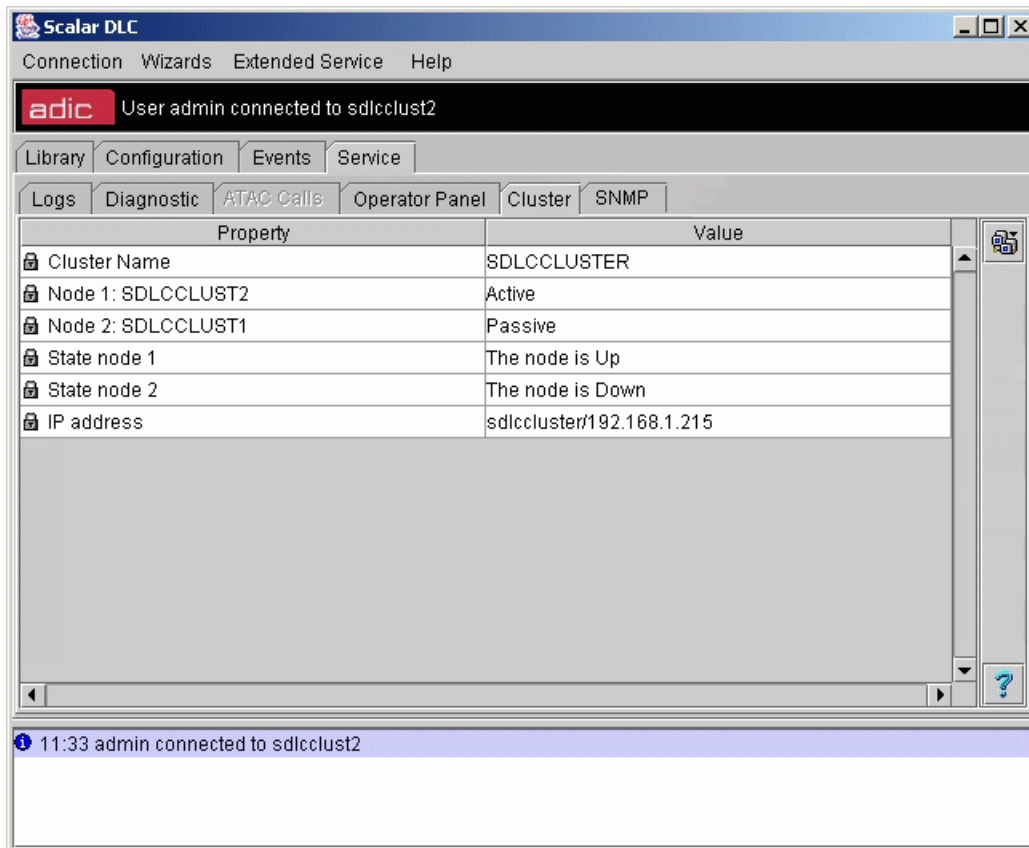

 **Note** This tab is available only when the Scalar DLC is installed as a failover (redundant) solution.

When the Scalar DLC software is installed on the host, it can be accessed by this host name (for example, **computer**). In a Cluster solution, there are two ways: either login to the active host (for example, **sdlcclust2**) or use a cluster virtual name (for example, **sdlccluster**). ADIC strongly recommends the second way because there is no way to predict what host is active when the customer tries to access the Scalar DLC host.

Figure 140 Cluster Tab



Field/Button	Icon	Operation	Description
Cluster name		Supplied	The virtual host name used to access both cluster nodes.
Node1		Supplied	Cluster Node1 name and status.
Node2		Supplied	Cluster Node2 name and status.
State node1		Supplied	Scalar DLC state on Node1.
State node2		Supplied	Scalar DLC state on Node2.

Field/Button	Icon	Operation	Description
IP address		Supplied	The IP address of the current cluster host.
Change cluster node		Click	Change active cluster node. The node that is currently active goes down and the node currently passive goes up. Note that this operation will be successful only when <u>both</u> node PCs are running.
Help		Click	Open online help for the current pane.

SNMP Tab

The SNMP tab displays current SNMP Service settings.



Note

This tab is available only when the SNMP Agent service is successfully started on Scalar DLC host PC.

To install the missing SNMP service, use **Control Panel > Add-Remove Windows Components > Management and Monitoring Tools > Simple Network Management Protocol**. Windows 2000 / 2003 system disk is required.

SNMP (Simple Network Management Protocol) is a network protocol used to manage TCP/IP networks. In Windows, the SNMP service is used to provide status information about a host on a TCP/IP network.

The SNMP Tab provides the same service as the SNMP Service options (**Windows Desktop > Start > Settings > Control Panel > Administrative Tools > Services > SNMP Service Properties**). It contains three additional tabs with the following properties:



- *Agents* is used to configure the settings for SNMP agents. Refer to [Agents](#) on page 200.
- *Traps* is used to configure the settings for SNMP traps. Refer to [Traps](#) on page 201.
- *Security* is used to configure the settings for SNMP security. Refer to [Security](#) on page 203.

Agents

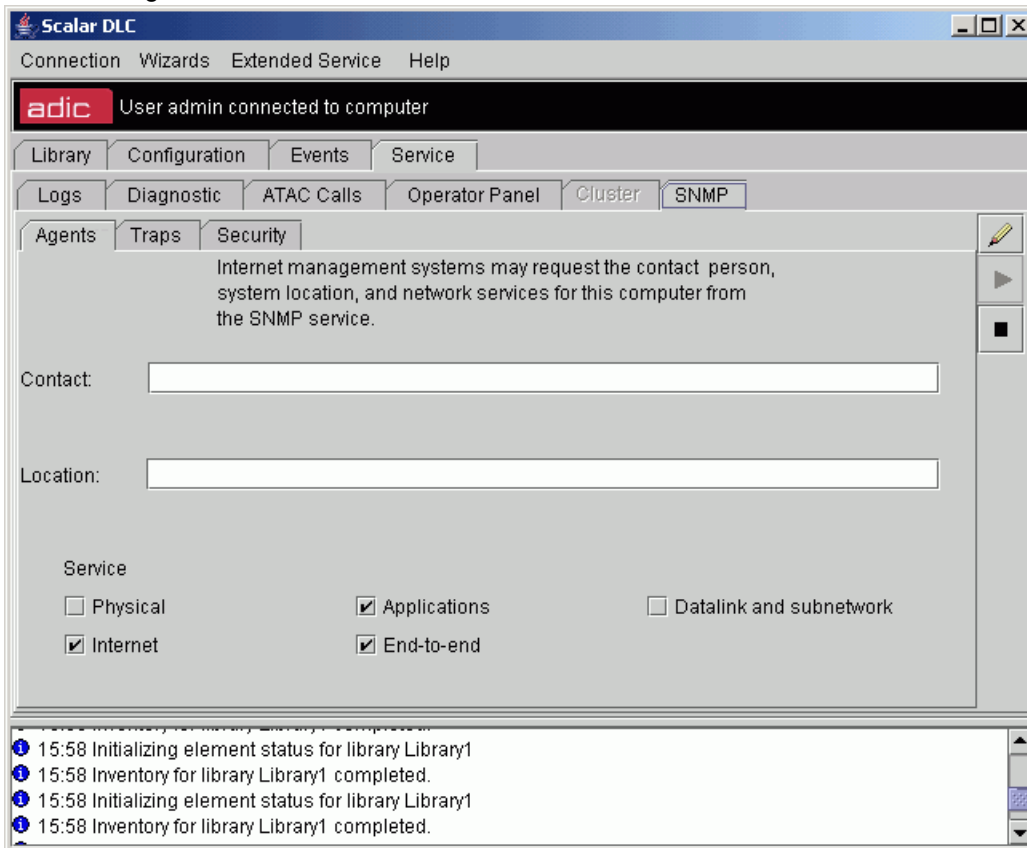
Figure 141 SNMP Agents



Agent is a computer running simple network management protocol (SNMP) agent software. In the Windows implementation of SNMP, agent information includes comments about the user, the physical location of the computer, and the types of service to report, based on the computer's configuration.

Field/Button	Icon	Operation	Description
Contact		Enter	Administrator or user (network account, local or domain) with the SNMP settings managing rights.
Location		Enter	Physical location of the computer or contact.
Service		Supplied	SNMP agent service settings
Physical		Do not check	Manage physical devices, such as a hard disk partition.
Internet		Check	IP gateway (router).
Applications		Check	Use any applications that send data using the TCP/IP protocol suite. This service should always be enabled.
End-to-end		Check	IP host. This service should always be enabled.
Datalink and subnet		Do not check	Manage a bridge.
Update		Click	Save SNMP properties after edit.
Start SNMP		Click	Start SNMP service (active when SNMP service is <i>stopped</i>).

Field/Button	Icon	Operation	Description
Stop SNMP	■	Click	Stop SNMP service (active when SNMP service is <i>started</i>).
Help	?	Click	Open online help for the current pane.



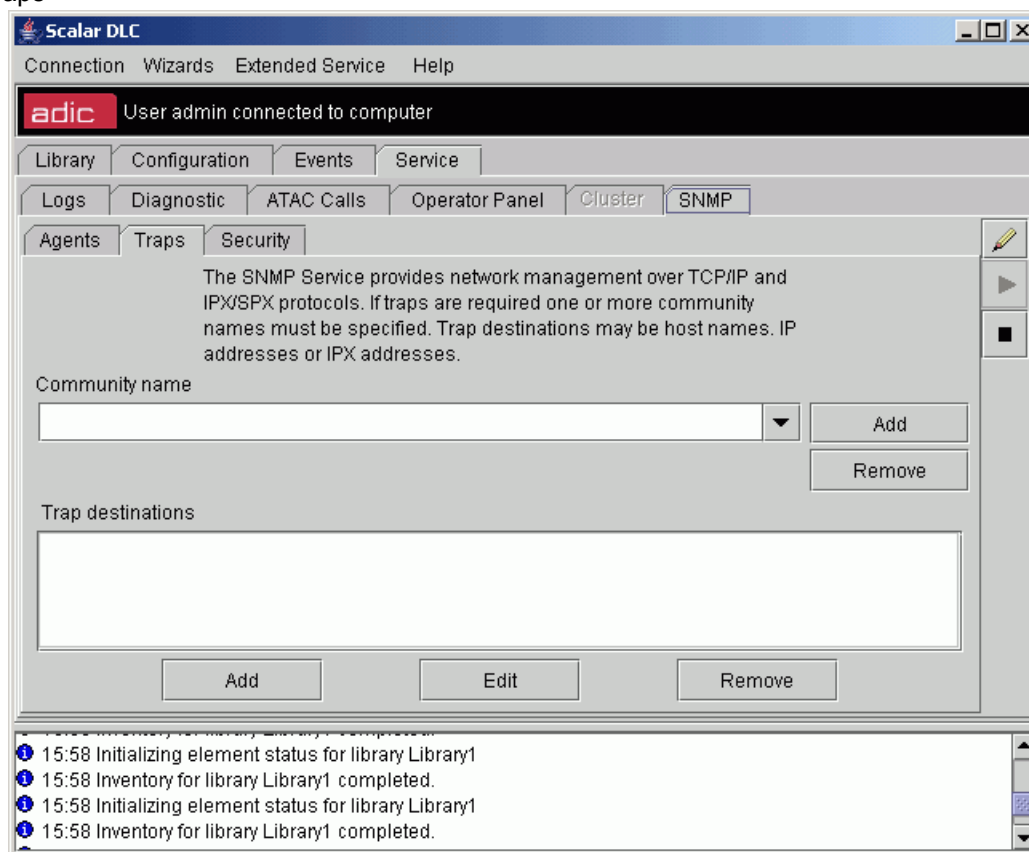

Traps

SNMP Traps



Trap is a message sent by an agent to a management system indicating that an event has occurred on the host running the agent. For example, the SNMP service can be configured to send a trap when it receives a request for information that does not contain the correct community name and does not match an accepted host name for the service.

Field/Button	Icon	Operation	Description
Community name		Enter/Select	Community to send traps.
Add		Click	Add new Trap community
Remove		Click	Remove community from list.
Trap destinations		Click to select	Current trap destinations
Add		Click	Add new trap. Pop-up SNMP Service Configuration dialog opens, see Figure 142 on page 202.

Field/Button	Icon	Operation	Description
Edit		Click	Edit trap. Pop-up SNMP Service Configuration dialog opens, see Figure 142 on page 202.
Remove		Click	Remove trap.
Update		Click	Save SNMP properties after edit.
Start SNMP		Click	Start SNMP service (active when SNMP service is <i>stopped</i>).
Stop SNMP		Click	Stop SNMP service (active when SNMP service is <i>started</i>).
Help		Click	Open online help for the current pane.

SNMP traps can be used for limited security checking. When configured for an agent, the SNMP service generates trap messages any time specific events occur. These messages are sent to a trap destination. For example, an agent can be configured to initiate an authentication trap if a request for information is sent by an unrecognized management system. Trap messages can also be generated for events such as host system startup or shutdown.

Trap destinations consist of the computer name or the IP or IPX address of the management system. The trap destination must be a network-enabled host that is running SNMP management software. Trap destinations can be configured, but the events (such as a system reboot) that generate a trap message are internally defined by the SNMP agent.

Figure 142 SNMP Service Configuration: Trap Destination

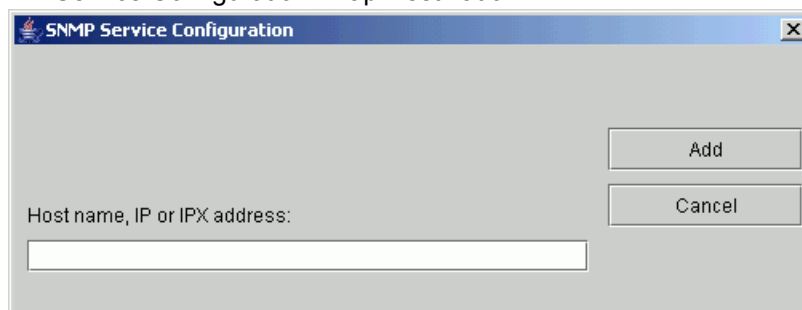



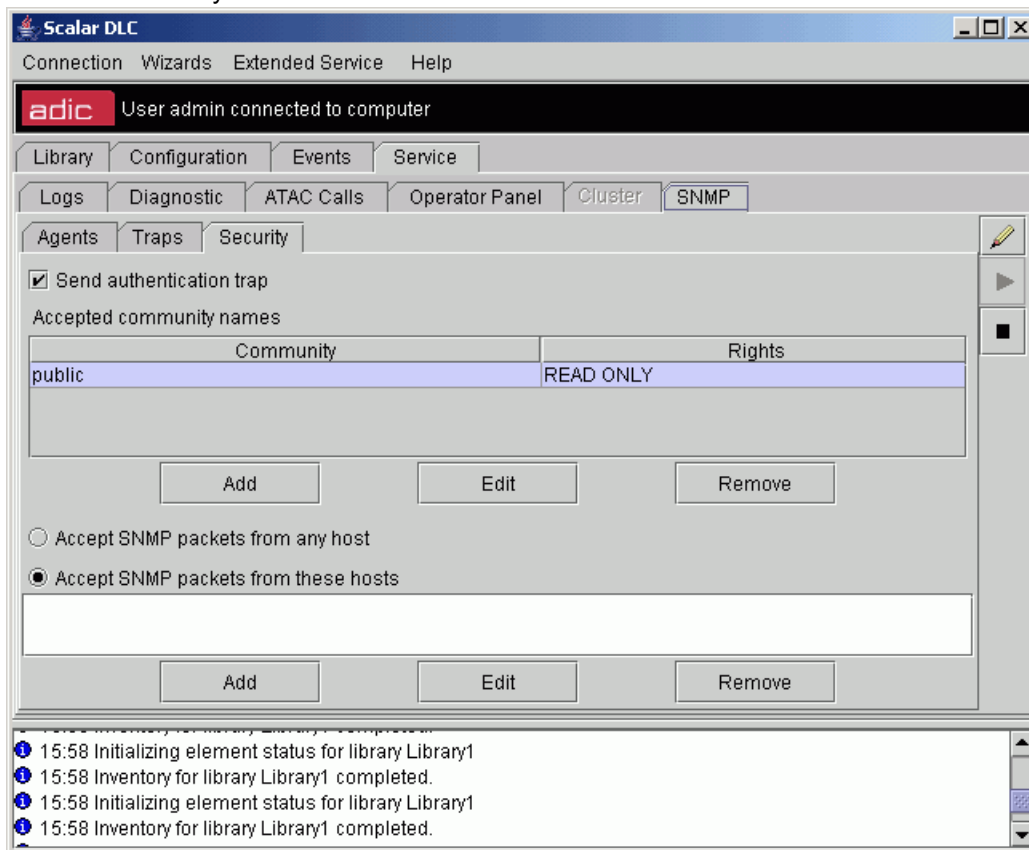

Security

Figure 143 SNMP Security



Field/Button	Icon	Operation	Description
Send authentication trap	<input checked="" type="checkbox"/>	Check	Authentication is the process of verifying that a host name or address is valid. When the SNMP agent receives a request that does not contain the correct community name or is not sent from a member of the acceptable host list, the agent sends an authentication trap message to one or more trap destinations (management systems), indicating the failure of authentication. This option is checked by default.
Accepted community names		Click to select	The service requires at least one default community name. 'Public' is the common community name that is universally accepted in all SNMP implementations. If an SNMP request is received from a community which is not on this list, it will generate an authentication trap.
Rights		Supplied	A permission level can be selected, determining how the SNMP agent processes requests from a selected community. For example, configure the permission level to block the SNMP agent from processing any requests from a specific community.
Add		Click	Add new community. Pop-up SNMP Service Configuration dialog opens, see Figure 144 on page 204.

Field/Button	Icon	Operation	Description
Edit		Click	Edit security settings for the community. Pop-up SNMP Service Configuration dialog opens, see Figure 144 on page 204.
Remove		Click	Remove community from list.
Accept SNMP packets		Select	<p><i>From all hosts</i> means that the source host and list of acceptable hosts are the source SNMP management system and the list of acceptable management systems. No SNMP packets are rejected on the basis of the name or address of the source host or the list of acceptable hosts.</p> <p><i>From these hosts</i> means that the acceptable hosts enlisted the acceptable SNMP management systems. When selected, only SNMP packets received from the hosts in this list are accepted. Otherwise, the SNMP message is rejected and an authentication trap sent. This selection provides greater security than using a community name, which might contain many hosts.</p>
Add		Click	Add new destination. Pop-up SNMP Service Configuration dialog opens, see Figure 142 on page 202.
Edit		Click	Edit destination. Pop-up SNMP Service Configuration dialog opens, see Figure 142 on page 202.
Remove		Click	Remove destination from list.
Update		Click	Save SNMP properties after edit.
Start SNMP		Click	Start SNMP service (active when SNMP service is <i>stopped</i>).
Stop SNMP		Click	Stop SNMP service (active when SNMP service is <i>started</i>).
Help		Click	Open online help for the current pane.



CAUTION

If all the community names will be removed including the default name 'Public', SNMP will not respond to any community names presented.

Figure 144 SNMP Service Configuration: Security

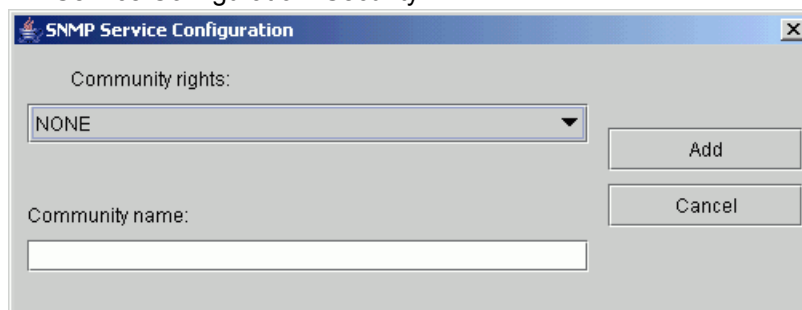

9

Tools and Utilities

This chapter describes the Tools and Utilities used as a part of the Scalar DLC software.

The available tools are:

- [Database Tool](#) on page 206. Managing the database.
- [SCSI Target Port Tool](#) on page 217. Managing SCSI Target Ports/Adapters.
- [Cluster Configurator Tool](#) on page 219. Making cluster configuration.
- [Problem Report Tool](#) on page 220. Preparing report issues for ATAC in case of unusual problems.
- [Log Viewer Utility](#) on page 221. Viewing the Scalar DLC log.
- [Trace Manager Utility](#) on page 226. Configuring the Scalar DLC trace.
- [Trace Viewer Utility](#) on page 230. Tracing the Scalar DLC.
- [Scalar DLC Software Licensing](#) on page 232. Requesting and/or installing the Scalar DLC software license.

Database Tool

To launch the tool, right-click on Scalar DLC status icon, or launch a shortcut: **Start > Programs > ADIC Distributed Library Controller > Scalar DLC DB Tool.**

This tool can execute a backup, a compact or a restore of a database, as well as create schedules for the backup and compact jobs. The following functions are offered:

- [Database Backup](#) on page 207 is for setting up the automatic database backup or executing a manual backup.
- [Extended Mode](#) on page 209 is for setting up the database recovery mode and setting up the transaction logs backup.
- [Database Compact](#) on page 212 is for setting up the database compact or executing the same operation manually.
- [Database Restore](#) on page 214 is for restoring the database with or without transaction logs from a regular backup, or restoring the database and transaction log from device (file).
- [Database Save](#) on page 216 is for saving the database archive excluding the temporary data.

The DB Tool requires a separate log on, as shown in [Figure 145](#).

Figure 145 Log On Dialog

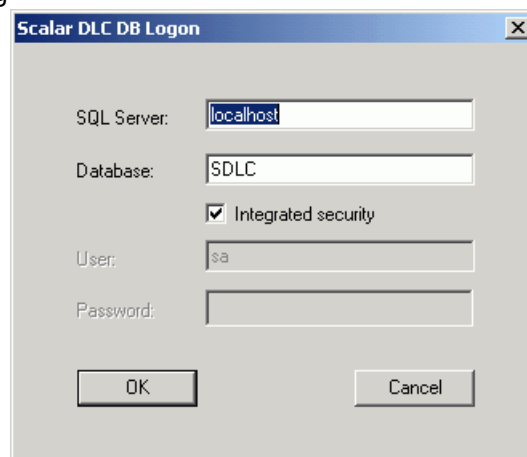

List	Operation	Description
SQL Server	Enter	The SQL server name.
Database	Enter	The database name, 'SDLC' by default.
User	Supplied Enter	SQL user with the admin rights (disabled for the trusted connection).
Password	Supplied Enter	SQL user password (disabled for the trusted connection).
Integrated security	Check Do not check	The user tries to access the database via trusted connection. The SQL Server admin name & password are to be specified.
OK	Click	Log on.
Cancel	Click	Clear the dialog and end the process.



Note

PC administrator rights are required to log on the SQL database via the trusted connection.

After the password is accepted and verified, the *Backup* dialog appears. Refer to [Database Backup](#) on page 207.

Database Backup

Figure 146 Database Backup

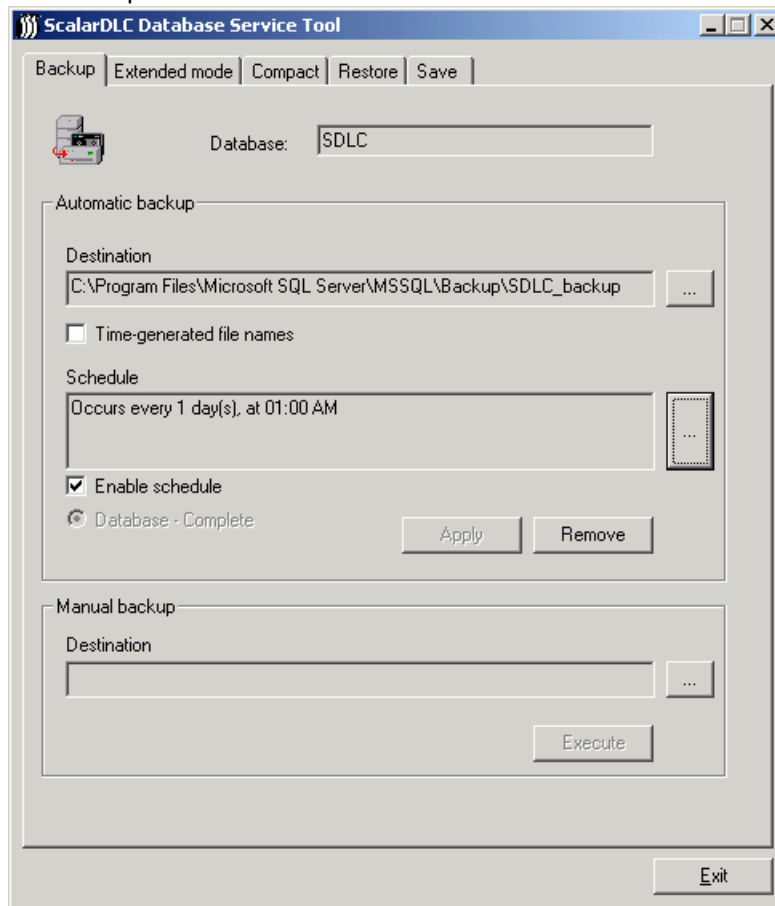

List	Operation	Description
Database	Supplied	The original database name.
Automatic backup		The automatic (scheduled) backup settings.
Destination	Supplied	The backup destination file. The "..." button on the left can be used to change the backup folder and enter the file name manually.
Time-generated file names	Check	If the box is checked, the name of the backup file will end with the backup date in typical SQL format (YYYYMMDDHHMMSS).
Schedule	Supplied	Schedule the automatic backup task. See Figure 147 on page 208.

List	Operation	Description
Enable schedule	Check	The schedule is applied only if this box is checked.
Database - complete	Supplied	Only <i>complete</i> backup is supported in current version.
Apply	Click	Apply automatic backup settings.
Remove	Click	Remove automatic backup job settings. After remove, all backup settings are lost and the backup must be configured again.
Maunal backup		The manual backup settings.
Destination	Supplied	The backup destination file. The "...“ button on the left can be used to change the backup folder and enter the file name manually.
Execute	Click	Execute the backup to a file.
Exit	Click	Exit the dialog without applying any changes.

Figure 147 Backup Schedule Dialog

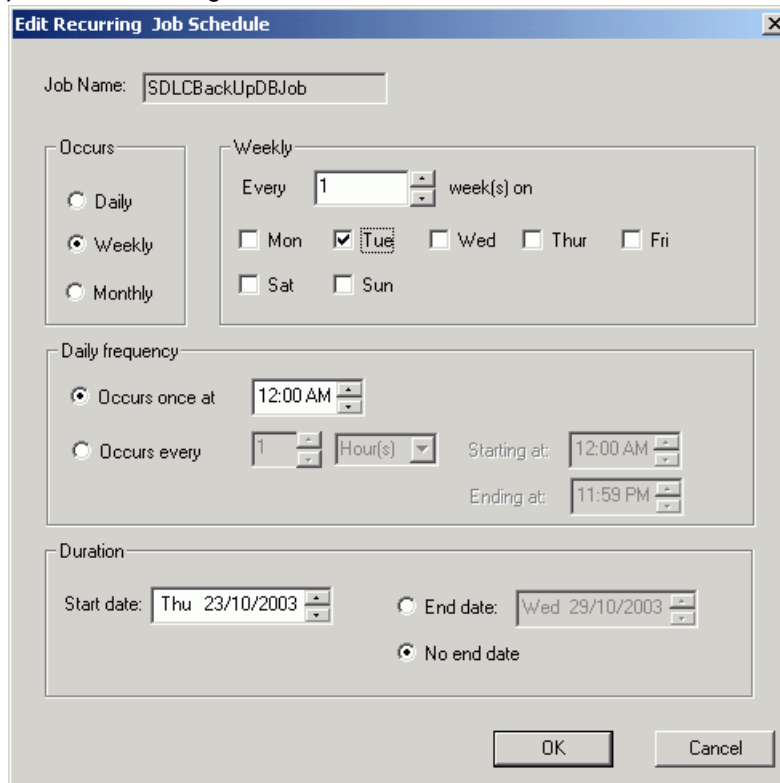

List	Operation	Description
Job Name	Supplied	The original Job name for <i>Backup</i> .
Occurs	Select	A daily backup.
		A weekly backup.
		A monthly backup.

List	Operation	Description
Daily/ Weekly/ Monthly	Select	<i>Daily</i> specifies the job execution days. <i>Weekly</i> specifies how often (in weeks) and the day for job execution. <i>Monthly</i> specifies how often each month or the exact day of each month.
Daily Frequency	Click	The single time or period of occurrence.
Duration	Click	The start and end date. The end date can be left unspecified.
OK	Click	Accept the input and exit.
Cancel	Click	Clear the dialog and exit.



Note

Always schedule different jobs at different times so that they do not overlap and will not conflict with each other.

Extended Mode

The Extended mode page is created to set up the database recovery mode and the log backup schedule.

Figure 148 Database Extended Mode Dialog

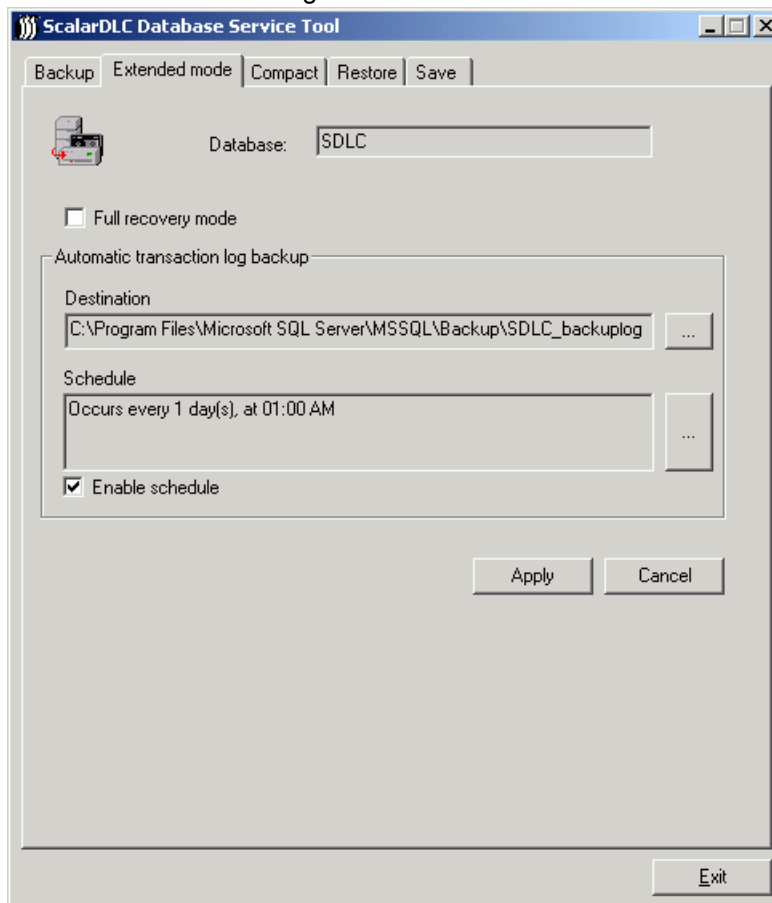

List	Operation	Description
Database	Supplied	The original database name.
Full recovery mode	Do not check	In full recovery mode the database is back up with all its logs which dramatically increase the size of backup file. Use this mode with caution only.
Automatic transaction log backup		The database log backup settings.
Destination	Supplied	The log backup destination file. The "...“ button on the left can be used to change the log backup folder and enter the file name manually.
Schedule	Supplied	Schedule the automatic log backup task. See Figure 149 on page 210.
Enable schedule	Check	The schedule is applied only if this box is checked.
Apply	Click	Accept the input.
Cancel	Click	Clear the dialog.
Exit	Click	Close the dialog without saving the input.

Figure 149 Backup Log Schedule Dialog

The screenshot shows the 'Edit Recurring Job Schedule' dialog box. The 'Job Name' field contains 'SDLCBackUpDBLogJob'. The 'Occurs' section has three radio buttons: 'Daily', 'Weekly' (selected), and 'Monthly'. The 'Weekly' section is expanded, showing 'Every 1 week(s) on' with a numeric spinner set to '1'. Below this are checkboxes for days of the week: Mon, Tue (checked), Wed, Thur, Fri, Sat, and Sun. The 'Daily frequency' section has two radio buttons: 'Occurs once at' (selected) and 'Occurs every'. The 'Occurs once at' option has a time spinner set to '12:00 AM'. The 'Occurs every' option has a numeric spinner set to '1', a unit dropdown set to 'Hour(s)', and 'Starting at' and 'Ending at' time spinners set to '12:00 AM' and '11:59 PM' respectively. The 'Duration' section has a 'Start date' spinner set to 'Thu 23/10/2003' and an 'End date' spinner set to 'Wed 29/10/2003'. There are also radio buttons for 'End date' (selected) and 'No end date'. At the bottom right are 'OK' and 'Cancel' buttons.

List	Operation	Description
Job Name	Supplied	The original Job name for <i>Backup Logs</i> .
Occurs	Select	A daily backup. A weekly backup. A monthly backup.
Daily/ Weekly/ Monthly	Select	<i>Daily</i> specifies the job execution days. <i>Weekly</i> specifies how often (in weeks) and the day for job execution. <i>Monthly</i> specifies how often each month or the exact day of each month.
Daily Frequency	Click	The single time or period of occurrence.
Duration	Click	The start and end date. The end date can be left unspecified.
OK	Click	Accept the input and exit.
Cancel	Click	Clear the dialog and exit.



Note

It is recommended to set the log backup rate higher as the database backup rate. For example, if the database backup is scheduled once a day, then schedule the database transaction logs backup to one an hour or so.



Note

Always schedule different jobs at different times so that they do not overlap and will not conflict with each other.

Database Compact

This feature reduces the Scalar DLC database file size to save the disk space and increase the database usability. The Compact Database operation can be executed only when the Scalar DLC software is *stopped*. Any attempt to execute the operation when the Scalar DLC software is working shall cause an error message.

Figure 150 Database Compact Dialog

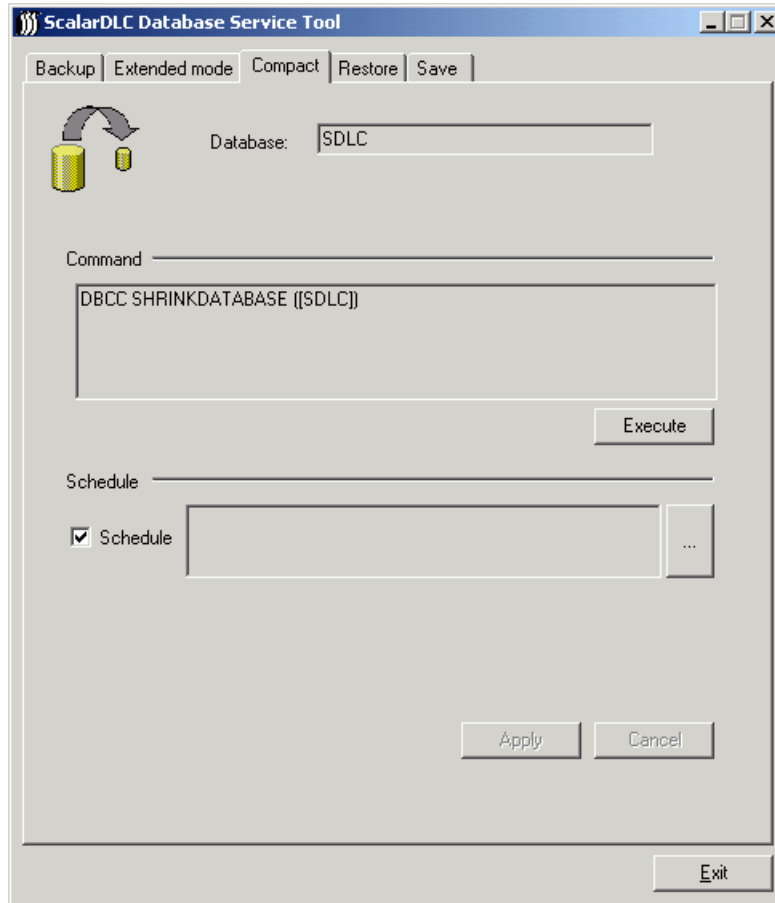

List	Operation	Description
Database	Supplied	The original database name.
Command	Supplied	The command associated with the compact.
Execute	Click	Immediate execution of the command.
Schedule	Check	Schedule the compact task. See Figure 151 on page 213.
Apply	Click	Accept the input.
Cancel	Click	Clear the dialog.
Exit	Click	Close the dialog without saving the input.

Figure 151 Compact Schedule Dialog

List	Operation	Description
Job Name	Supplied	The original Job name for <i>Compact</i> .
Occurs	Select	A daily compact. A weekly compact. A monthly compact.
Daily/ Weekly/ Monthly	Select	<i>Daily</i> specifies the job execution days. <i>Weekly</i> specifies how often (in weeks) and the day for job execution. <i>Monthly</i> specifies how often each month or the exact day of each month.
Daily Frequency	Click	Establish either the single time or period of occurrence.
Duration	Click	Set the start and end date. The end date can be left unspecified.
OK	Click	Accept the input and exit.
Cancel	Click	Clear the dialog and exit.



Note

Always schedule different jobs at different times so that they do not overlap and will not conflict with each other.

Database Restore

This feature imports the Scalar DLC database contents either from the regular backup (databases, see [Figure 152](#)) or external file (disk, see [Figure 153](#) on page 215). The Restore Database command can be executed only when the Scalar DLC software is stopped. Any attempt to execute the operation when the Scalar DLC software is working shall cause an error message.

Restoring database from backup can also include restoring all transaction logs so not only the configuration but the latest command list will be restored, too.

Figure 152 Database Restore Dialog (by backup)

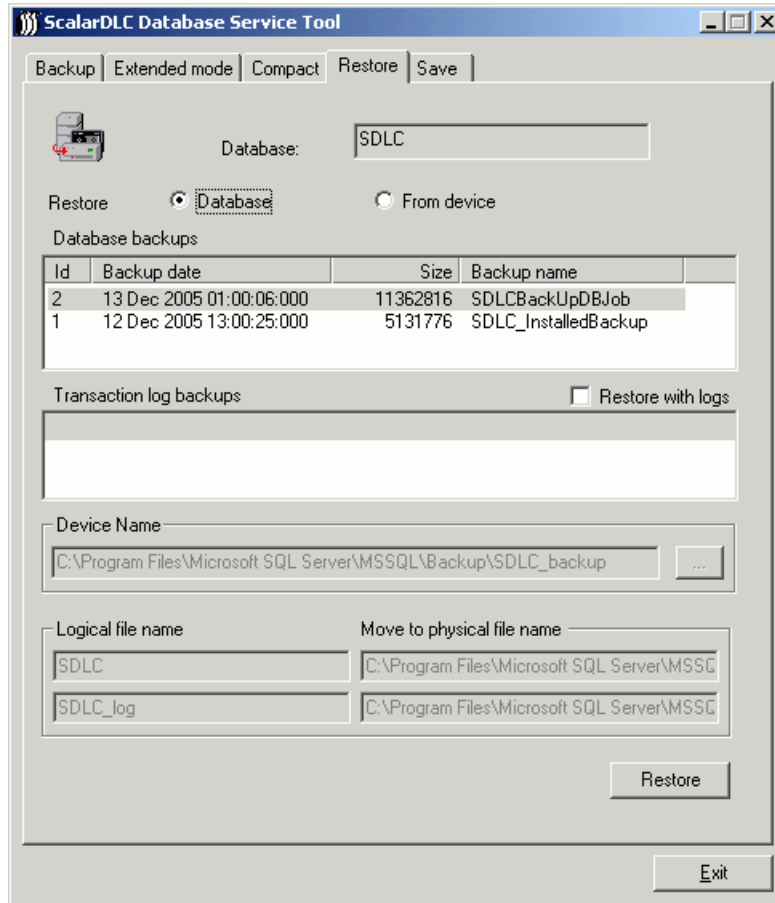

List	Operation	Description
Database	Supplied	The original database name.
Restore	Select	<i>Database</i> is for restoring database by previous backup. See Figure 152 . <i>From Device</i> is for restoring database from file. See Figure 153 on page 215.
Database backups	Select	ID The backup ID. Backup date The date and time of the database backup. Size Database size. Backup name The backup set name.

List	Operation	Description	
Restore with logs	Check	Restore the database with transaction logs if checked.	
Transaction log backups	Select	ID	The backup ID.
		Backup date	The date and time of the transaction log backup.
		Size	Transaction log size.
		Backup name	The transaction log set name.
Restore from file	Select	Device Name	The name of device (file) to restore the database.
		...	The device (file) to restore database from.
		Logical file name	The path to the existing database files.
		Move to physical file name	The file names to restore the database (DB and transaction log) can be entered manually.
Restore	Click	Accept the input and restore the database.	
Exit	Click	Close the dialog.	

Figure 153 Database Restore Dialog (restore from device)

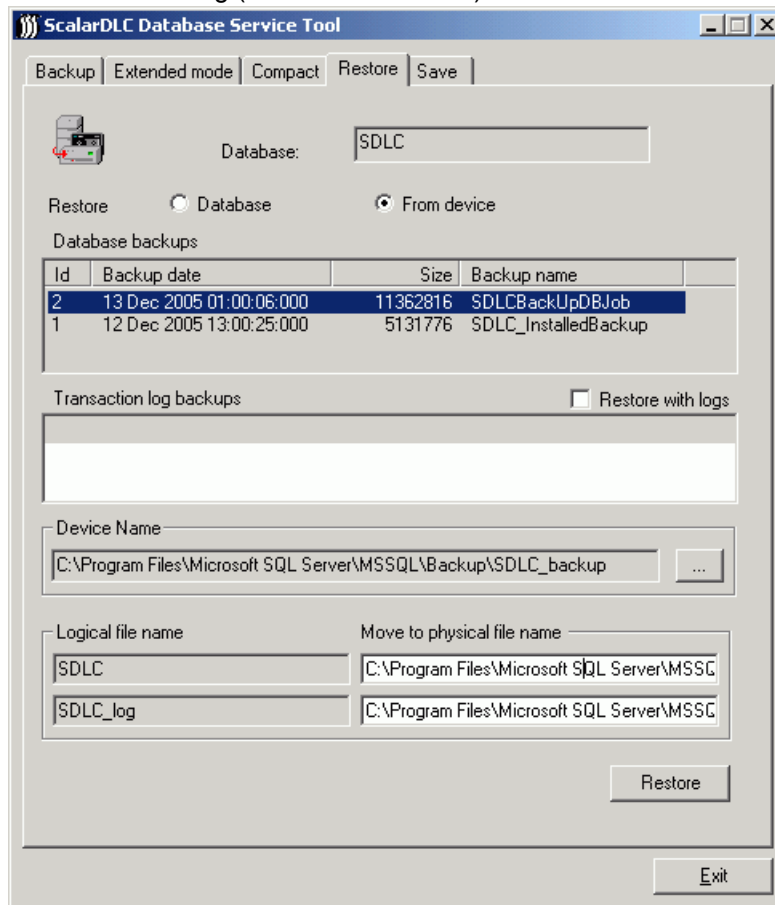

Database Save

This feature creates the archive with the Scalar DLC database backup contents and saves the archive to the destination specified. The database backup however holds only sufficient information, without temporary data (notifications, moves executed, etc.). See [Table 26](#).

Table 26 Database Archive

Data description	Saved
Physical libraries data, statistics, media rules, partitions, logical libraries	Yes
Logical library statistics, pools, mailboxes, drives, cartridges	Yes
Clients, client interface settings, reserve and define ranges, aliasing	Yes
Move commands history, list of notifications sent	No
Users and user settings, registration info; Notification rules, tickets, SNMP settings	Yes

Figure 154 Database Save Dialog

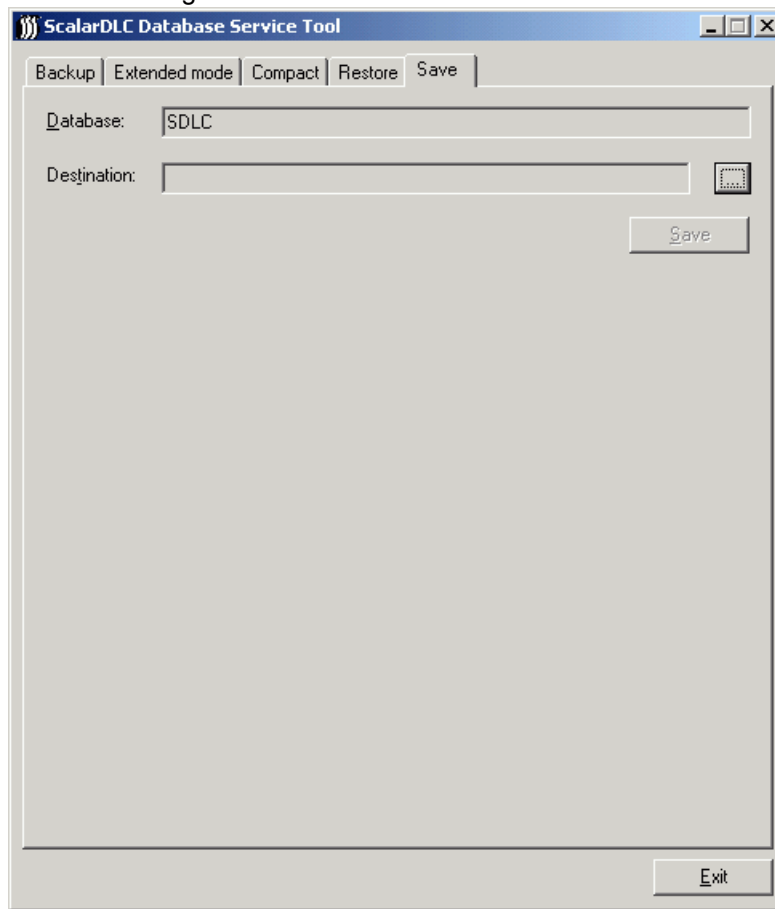

List	Operation	Description
Database	Supplied	The original database name.
Destination	Enter	The archive file destination.
Save	Click	Save database to archive.
Exit	Click	Close the dialog.

SCSI Target Port Tool

To launch the tool, right-click on Scalar DLC status icon and select **Tools > SCSI Target Port Tool**.

The Scalar DLC SCSI Target Port Tool is designed for operating the system SCSI Target ports. If the SCSI port is currently in Target mode and the customer wants to change it to Initiator, the port must be disabled as Target before enabling it as Initiator. This operation is executed via the SCSI Target Port Tool.

Immediately after the Scalar DLC software and the Target drivers are installed, the SCSI Target ports can be disabled. To make them operational, enable the ports via the SCSI Target Port tool.



CAUTION

Enable only the ports that should operate in Target mode. An attempt to use the Initiator port as a Target may cause a system crash (for example, if the hard disk is connected to the adapter, its port must work in Initiator mode).



Note

Do not use two adapters of the same model in different operation modes (Initiator and Target). Otherwise, it is possible to make a mistake and enable an Initiator as a Target.

After disabling the SCSI Target Port, launch the **Device Manager** and enable the SCSI port as an *Initiator*. Restart the system afterwards. Enabling a SCSI port as a *Target* can be done via the SCSI Target Port tool (a reboot may be required).

Figure 155 SCSI Target Port Tool

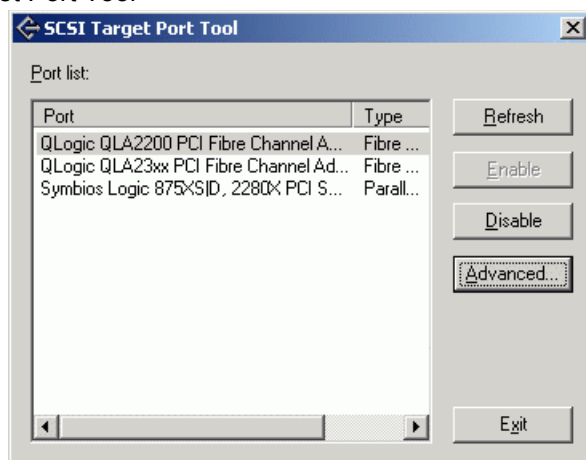

List	Operation	Description
Port list	Select	<i>Port</i> is the port full name. <i>Type</i> is a port type. <i>Status</i> is a port status (enabled/disabled).
Refresh	Click	Refresh the port list.
Enable	Click	Enable the <u>disabled</u> SCSI Target port.
Disable	Click	Disable the <u>enabled</u> SCSI Target port.
Advanced	Click	Advanced port settings (only for Fibre Channel ports). See Figure 156 .
Exit	Click	Close the SCSI Target Port Tool.

Figure 156 Advanced Port Settings

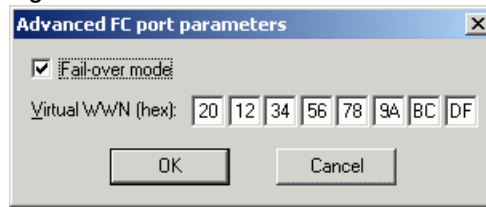

Parameter	Operation	Description
Failover mode	Check	Must be checked if the Scalar DLC failover (cluster) solution has been installed.
Virtual WWN	Enter	Virtual world-wide name that identifies the port from outside.
OK	Click	Update and exit.
Cancel	Click	Exit without update.

Cluster Configurator Tool

This tool should be used only for the Scalar DLC installed as a failover (cluster) solution.

Immediately after the Scalar DLC software is installed on both cluster nodes launch the cluster configurator tool. It can be found on the Scalar DLC Installation CD with the following path:

Scalar_DLC\Cluster\SDLC_ClusterConfig.exe.

Figure 157 Cluster Configuration Utility: no configuration

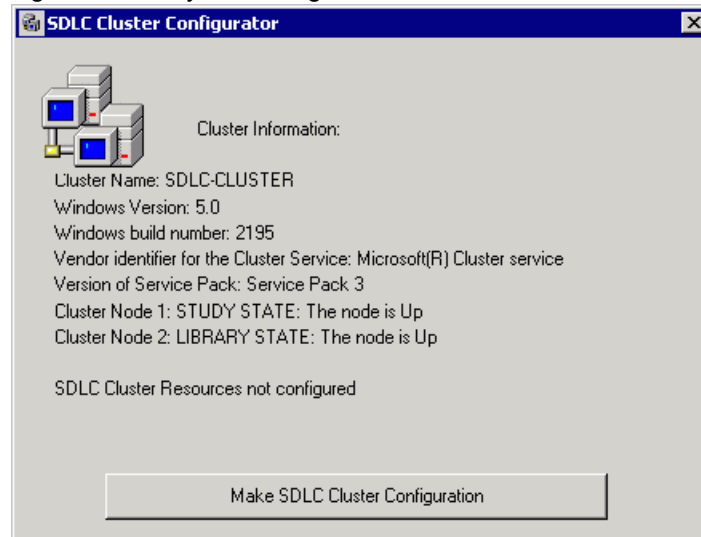

Click **Make SDLC Cluster Configuration** to configure Scalar DLC software for a failover mode. When the configuration is completed, the pop-up “Configuration created successfully” window opens. Click **OK** to return to the SDLC Cluster Configurator.

Figure 158 Cluster Configuration Utility: configuration complete

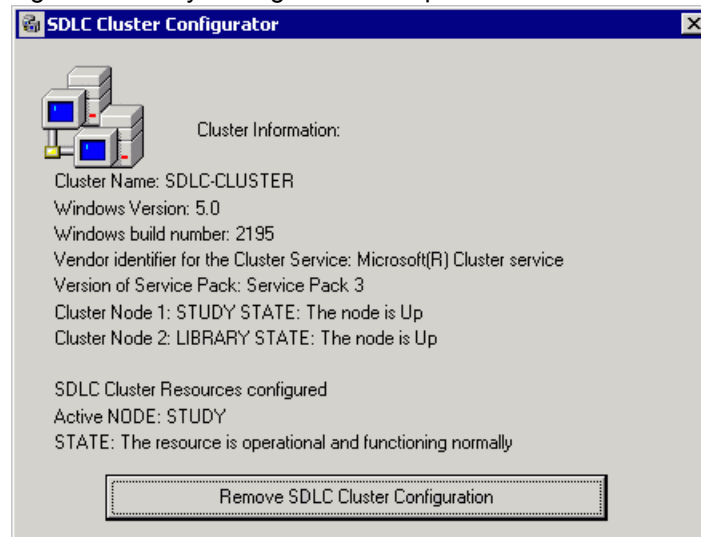

The **Remove SDLC Cluster Configuration** button should be used only to re-configure Scalar DLC software from failover (cluster) to basic (non-cluster) mode. If this is executed on a cluster, the Scalar DLC failover solution will not function. However, the Scalar DLC itself will work in a basic mode (as if it has been installed on standalone PC).

Problem Report Tool

To start the Report Tool launch a shortcut: **Start > Programs > ADIC Distributed Library Controller > Scalar DLC Problem Report Tool.**

Figure 159 Problem Report Tool

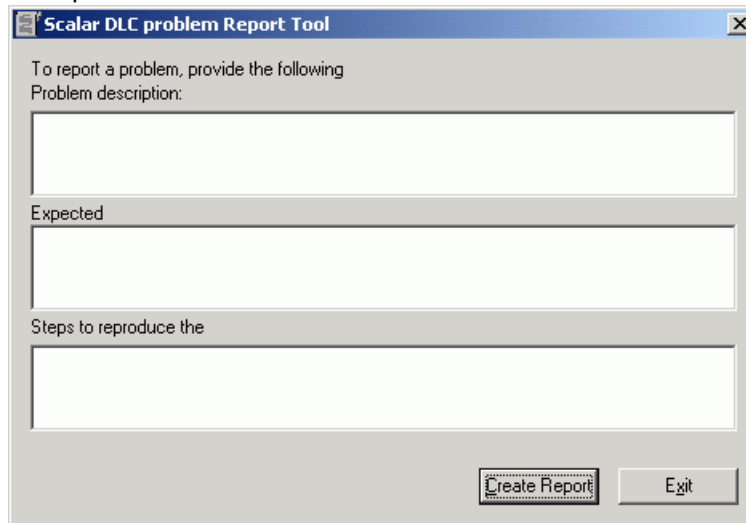

The screenshot shows a Windows-style dialog box titled "Scalar DLC problem Report Tool". The dialog contains three text input fields. The first field is labeled "Problem description:". The second field is labeled "Expected". The third field is labeled "Steps to reproduce the". At the bottom of the dialog, there are two buttons: "Create Report" and "Exit".

Describe the problem step-by-step. Clarify what has been expected and what should be done to reproduce the problem. Then press **Create Report** to save the report file on disk; the report file will include the entered description, the system register, and so forth.

After the report file is saved, it can be sent to the ADIC customer support via email.

Log Viewer Utility

To launch the tool, right-click on the Scalar DLC status icon and select **Tools > Log Viewer**.

Figure 160 Log Viewer Main Window

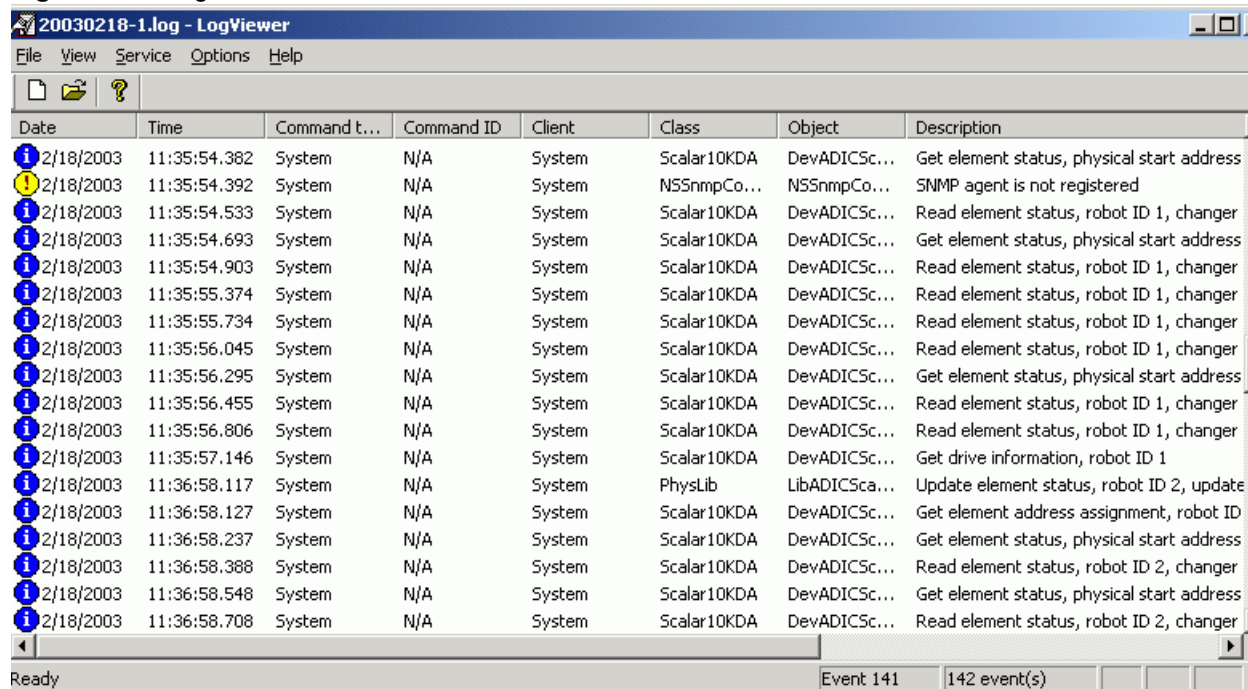

Icon	Name	Description
	Normal	Information messages. They usually contain the description of successfully executed operation.
	Warning	Warning messages. Something is not working as it should; however, there is no danger. The Scalar DLC functions are enabled and the operation has finished successfully.
	Error	Error messages. They typically contain the description of the operation that has been canceled because of error. The error code and description are also contained if they are known.
	Critical failure	Critical error messages associated with an error condition that could cause a software or system failure. An immediate action may be required.

The Log Viewer tool is designed to view the logs of Scalar DLC software operations if an error situation has appeared and the error content is needed.

When an error occurs, find it in the log (for example, filter to show only errors), look by the command ID in what object the first error has appeared and see the error description and error content by the code. Find where and when the error appears and check the states of appropriate logical and physical libraries, robots, and so forth, in the appropriate period of time. Analyze command type, object, and client fields.

In some cases however the log itself does not contain sufficient information to reproduce the problem. The client database may be required. Open **Start > Programs > ADIC Distributed Library Controller > Scalar DLC DB Tool**, select *Backup* tab, save it to a specified location (see [Figure 146](#) on page 207) and send the file via email.

The command tracking feature eases the search for an error. See [Figure 161](#) for the illustration and [Table 27](#) on page 223 for the feature description.

Figure 161 Log Viewer: Command Tracking

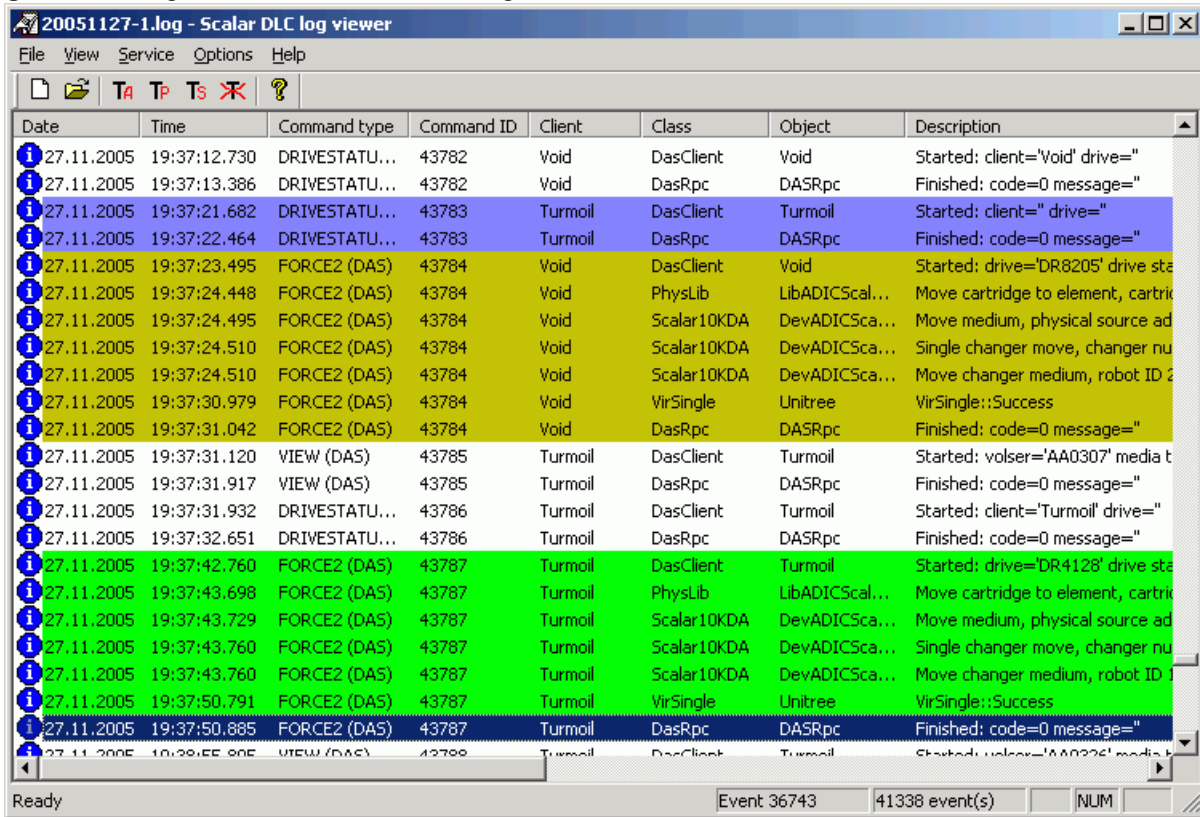

Double-click on the log message to display the event context (see [Figure 162](#)).

Figure 162 View Event

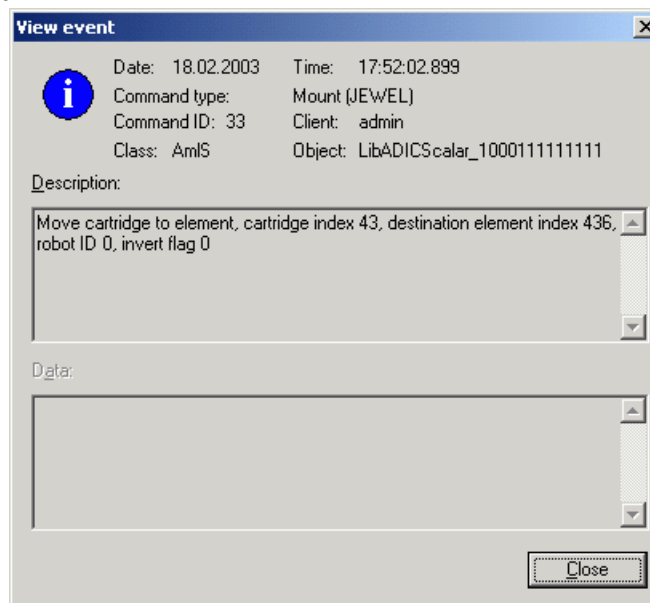

The menu operations available in Log Viewer Utility are shown in [Table 27](#) on page 223. Note that some operations are also available via the tool bar buttons and/or keyboard shortcuts.

Table 27 Log Viewer Operations







Menu	Description	Button	Shortcut
File	<ul style="list-style-type: none"> • <i>Current</i> - open the current (latest) Scalar DLC log file in its default location. 		<Ctrl+C>
	<ul style="list-style-type: none"> • <i>Open</i> - browse for the log. 		<Ctrl+O>
	<ul style="list-style-type: none"> • <i>Exit</i> - close the Log viewer tool. 		
View	<ul style="list-style-type: none"> • <i>Current event context</i> - open the details for the selected event (see Figure 162 on page 222). 		<Enter>
	<ul style="list-style-type: none"> • <i>Show/hide tool bar</i> - show or hide the toolbar. 		
	<ul style="list-style-type: none"> • <i>Show/hide status bar</i> - show or hide the status bar. 		
	<ul style="list-style-type: none"> • <i>Refresh</i> - refresh the current log. 		<F5>
Service	<ul style="list-style-type: none"> • <i>Result description</i>, as indicated by Figure 163 on page 224 - lookup for the error code description. 		
	<ul style="list-style-type: none"> • <i>Search</i>, as shown in Figure 164 on page 224 - search engine. 		<Ctrl+F3>
	<ul style="list-style-type: none"> • <i>Search next</i> - search for the same item again. 		<F3>
	<ul style="list-style-type: none"> • <i>Goto event</i>, as shown in Figure 165 on page 224 - go to certain event. 		<F4>
	<ul style="list-style-type: none"> • <i>Track active item / stop tracking</i> - track the command of the selected event. All events for the command will be shown in light-green color. Selecting another event in the log results the tracking of another command. Click the button again to stop tracking. 		
	<ul style="list-style-type: none"> • <i>Track item / stop tracking</i> - select the event to track. All events for the command will be shown in light-green color. Selecting another event will NOT move the tracking. Click the button again to stop tracking. 		<Ctrl+A>
	<ul style="list-style-type: none"> • <i>Track secondary item / stop tracking</i> - select the secondary event to track (when it is required to track more than one command). All events for the secondary command will be shown in dark-yellow color, then in blue, then in pink (see Figure 161 on page 222). Tracing only up to three secondary commands is allowed (tracking the fourth command results removing the tracking of the first one). Selecting another event will NOT move the tracking. Click the button again to stop tracking. 		<Ctrl+D>
	<ul style="list-style-type: none"> • <i>Cancel tracking</i> - stop all tracking. 		
Options	<ul style="list-style-type: none"> • <i>Logging</i>, as shown in Figure 166 on page 224 		
	<ul style="list-style-type: none"> • <i>Filtering</i>, as shown in Figure 167 on page 225. 		
	<ul style="list-style-type: none"> • <i>Viewing</i>, as shown in Figure 168 on page 225. 		
Help	<ul style="list-style-type: none"> • <i>About</i> - Log Viewer current version. 		

Figure 163 Result Description



Enter the error number (for example, 0x00000005) and click **Lookup** to see the error content (in the example code, *Access is denied*).

Figure 164 Search

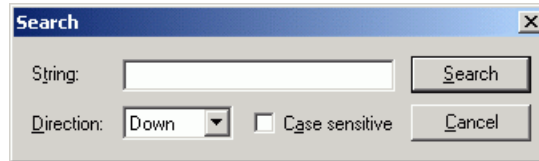

Typical search engine. Enter the string to find, specify options and click **Search**.

Figure 165 Goto Event



The Goto event pane allows user to jump on event with the specified number.

Figure 166 Logging Options

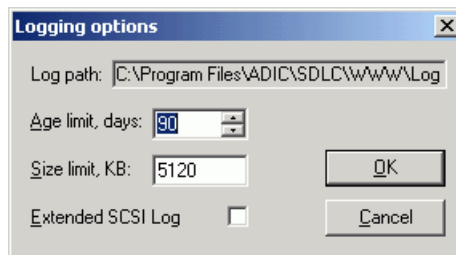

List	Operation	Description
Log path	Supplied	The log file path.
Age limit, days	Enter	The age limit in days. Only natural numbers are allowed. All the log files older than the age limit will be removed automatically at midnight. "0" means "no age limit."
Size limit, KB	Enter	The size limit in KB. Only natural numbers are allowed. If the log file size exceeds the size limit, the new log file is created for current session. "0" means "no size limit."
Extended SCSI log	Do not check	When the box is <u>checked</u> , in no more than 180 sec all Scalar DLC objects will log the extended SCSI data concerning executed operation (CDB, command ID, etc.). The size of log file greatly increases, so use this feature only when the SCSI communications work unstable and there is needed to locate the weak phase.
OK	Click	Save the options and exit this pane.
Cancel	Click	Close the pane without saving the changed options.

Figure 167 Filtering Options

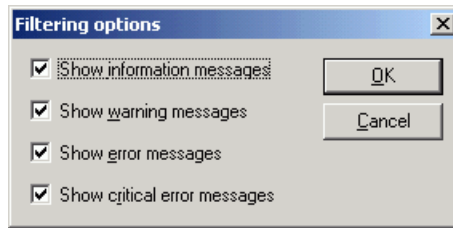

List	Operation	Description
Show information messages	Check	Normal messages are shown.
Show warning messages	Check	Warning messages are shown.
Show error messages	Check	Error messages are shown.
Show critical error messages	Check	Critical error messages are shown.
OK	Click	Save the options and exit this pane.
Cancel	Click	Close the pane without saving the changed options.

Figure 168 Viewing Options

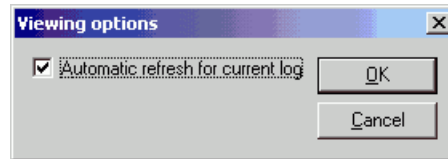

Check the box to auto-refresh the current log.

Trace Manager Utility

To launch the tool, right-click on Scalar DLC status icon and select **Tools > Trace Manager**.

Trace Manager tool is designed for tracing the execution of Scalar DLC software objects.



CAUTION

Tracing the Scalar DLC slows its work as well as the work of client backup applications that use the Scalar DLC as server software. The higher is the configured trace level the slower is the work of the Scalar DLC itself, so use the tracing feature only when needed.

Figure 169 Trace Manager Main Window

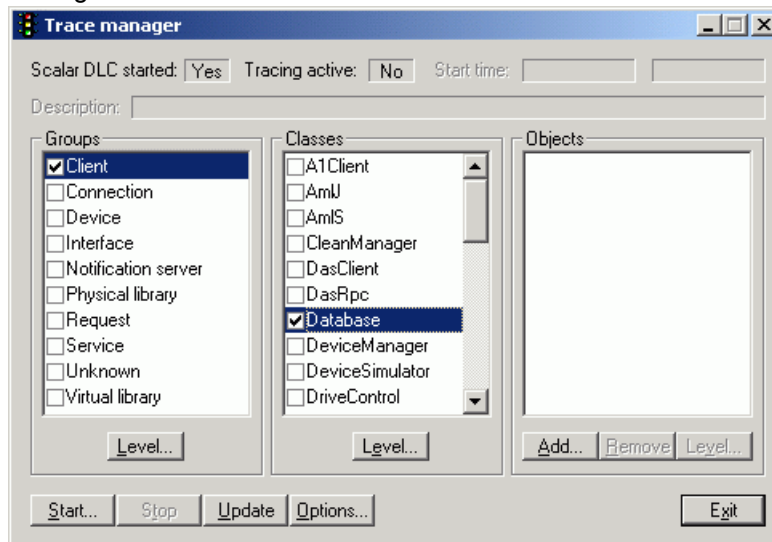

Field/Button	Operation	Description
Scalar DLC started	Supplied	Shows Yes if the Scalar DLC is started, No if it is stopped.
Tracing Active	Supplied	Shows Yes if the Tracing process is started, No if it is not.
Start time	Supplied	Shows the start time and current time for the Tracing process.
Description	Supplied	Shows the description of current tracing process.
Groups	Check	The object groups list. If the selected group is checked, the button Level becomes active.
Level	Click	Choose the sensitivity level for the tracing current group. See Figure 170 on page 227.
Classes	Check	The object classes list. If the selected class is checked, the Level button becomes active.
Level	Click	Choose the sensitivity level for the tracing current class. See Figure 171 on page 227.
Objects	Check	The objects list. If the selected object is checked, the Level button becomes active.
Add	Click	Adds the objects for tracing. See Figure 172 on page 228.

Field/Button	Operation	Description
Remove	Click	Removes the objects from tracing list.
Level	Click	Chooses the sensitivity level for the tracing current object. See Figure 174 on page 228.
Start	Click	Start the tracing. See Figure 175 on page 229.
Stop	Click	Stop the tracing.
Update	Click	Save the current trace manager options as default.
Options	Click	Show the trace manager options pane. See Figure 176 on page 229.
Exit	Click	Close the pane without saving the changed options.

Figure 170 Group Level

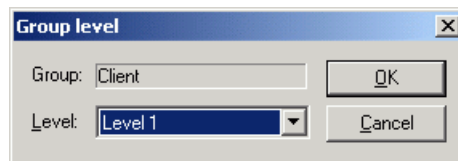

List	Operation	Description
Group	Supplied	Group name.
Level	Select	The sensitivity level where one is minimum and five is maximum.
OK	Click	Save the options and exit this pane.
Cancel	Click	Close the pane without saving the changed options.

Figure 171 Class Level

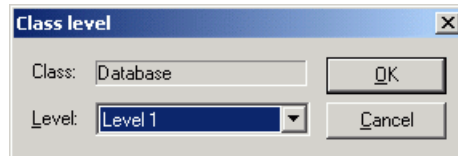

List	Operation	Description
Class	Supplied	Class name.
Level	Select	The sensitivity level where one is minimum and five is maximum.
OK	Click	Saves the options and exit this pane.
Cancel	Click	Closes the pane without saving the changed options.

Figure 172 Add Object



List	Operation	Description
Object	Enter	Object name.
Trace level	Select	The sensitivity level where one is minimum and five is maximum.
Add	Click	Add object and close the pane.
Cancel	Click	Close the pane without adding object.
Existing	Click	Choose the existing object to trace. See Figure 173 on page 228.

Figure 173 Add Existing Object

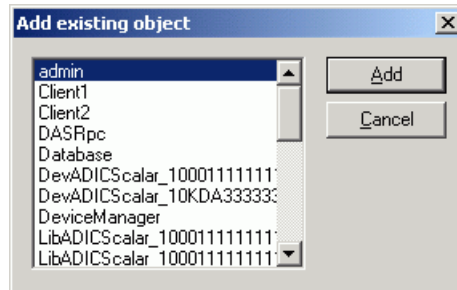

List	Operation	Description
Object list	Select	The objects to add.
OK	Click	Add the selected object.
Cancel	Click	Close the pane without adding the object.

Figure 174 Object Level

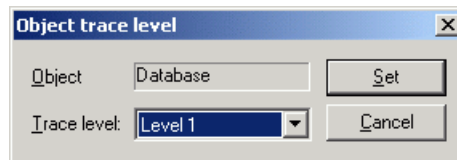

List	Operation	Description
Object	Supplied	Object name.
Level	Select	The sensitivity level where one is minimum and five is maximum.
Set	Click	Save the options and exit this pane.
Cancel	Click	Close the pane without saving the changed options.

Figure 175 Start Tracing

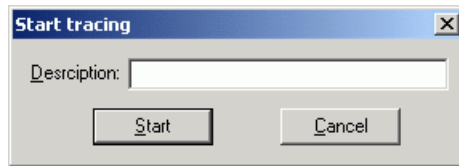

List	Operation	Description
Description	Enter	The tracing description should be entered here.
Start	Click	Start the tracing process.
Cancel	Click	Close the pane without starting the tracing.

Figure 176 Tracing Options

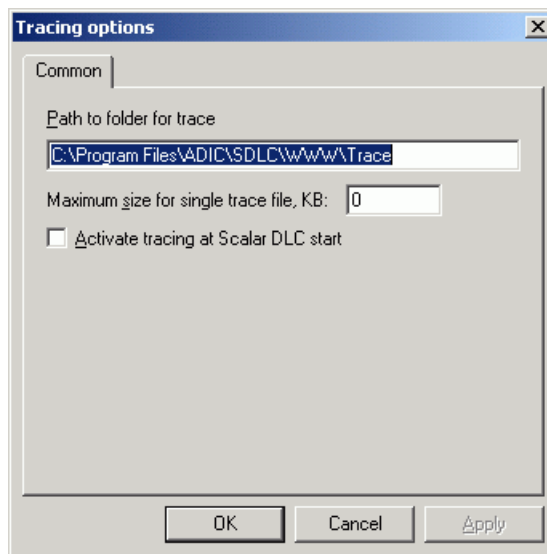

List	Operation	Description
Path to folder for trace	Enter	A trace path. .. \ADIC\SDLC\WWW\Trace is the default path.
Maximum size for single trace file, KB	Enter	The size limit in KB is shown here. Natural numbers are allowed only. If the trace file size exceeds the size limit, the new trace file is created for current session. '0' means 'no size limit'.
Activate tracing at Scalar DLC start	Check	Check if the tracing should start automatically when Scalar DLC supervisor starts.
OK	Click	Save options and close the pane.
Cancel	Click	Close the pane without saving options.
Apply	Click	Set the current tracing options as default.

Trace Viewer Utility

To launch the tool, right-click on Scalar DLC status icon and select **Tools > Trace Viewer**.

The Trace Viewer tool is designed for viewing the trace files generated by [Trace Manager Utility](#) on page 226 during execution of the Scalar DLC software.

Figure 177 Trace Viewer Main Window

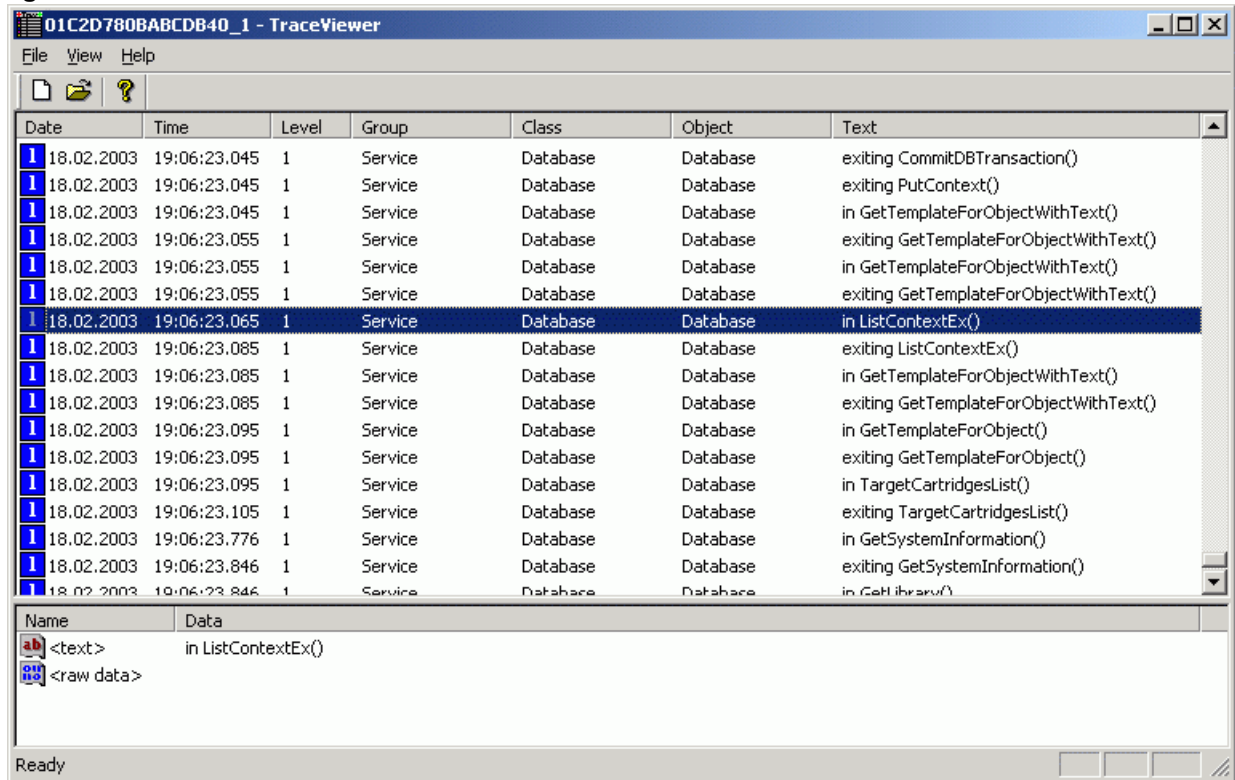

Menu	Description
File	Typical trace-file operations: current, open, exit.
View	Viewer options: show current record context using <Enter> (see Figure 178 on page 231), show tool bar, show status bar, refresh using <F5>.
Help	Trace Viewer current version.

Double-click on the trace record to display the trace in a more detailed form ([Figure 178](#) on page 231).

Figure 178 View Trace Record

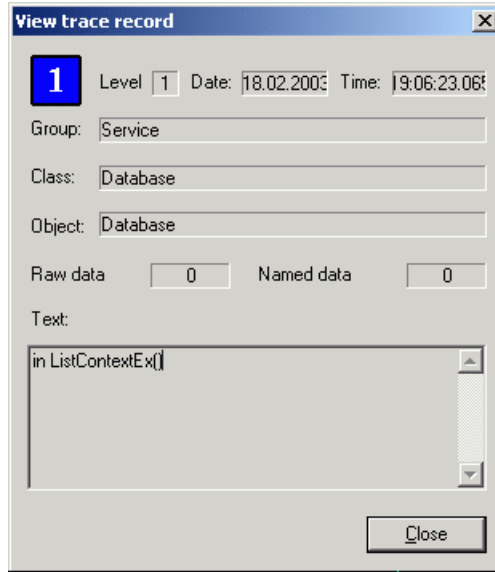

List	Operation	Description
Level	Supplied	The sensibility level needed to trace the event. The level is also shown inside the color icon.
Date	Supplied	Record date.
Time	Supplied	Record time.
Group	Supplied	Group name.
Class	Supplied	Class name.
Object	Supplied	Object name.
Raw data	Supplied	The binary record data.
Named data	Supplied	The text record data.
Text	Supplied	Record text.
Close	Click	Close the pane.

Scalar DLC Software Licensing

The Scalar DLC software will run for a “grace period” of 30 days after installation without a license. Thereafter, a license key is required to keep the software running. This key should be obtained by contacting ATAC before the 30-days trial period expires.

To request a license, contact ADIC by either email or fax.

- Send the license request by email from the license application module.
- Print the license request text file, license.lic, and fax the file to ATAC at 1.303.792.0056.

The Licensing tool is used for both Scalar DLC Basic solution ([Standard License](#) on page 232 and Failover solution ([Cluster License](#) on page 237).

Standard License

Refer to [Obtaining License](#) on page 232 to request a Scalar DLC license.

The license request can be sent either by email or fax. For a fax, the file is located at <%SystemDrive%>\Program Files\ADIC\SDLC\docs\license.lic.

Once the license request is received and is validated by ADIC, a license string is sent back to the sender to be entered into Scalar DLC software.

Refer to [Installing License](#) on page 236 for registering the Scalar DLC license.

Obtaining License

The Scalar DLC license request can be resolved in one of two ways. During the installation process, execute the ADIC Licensing application and click **Request**.

The Licensing dialog is also available through **Start > Programs > ADIC Distributed Library Controller > ADIC Licensing**.

Figure 179 Licensing Dialog

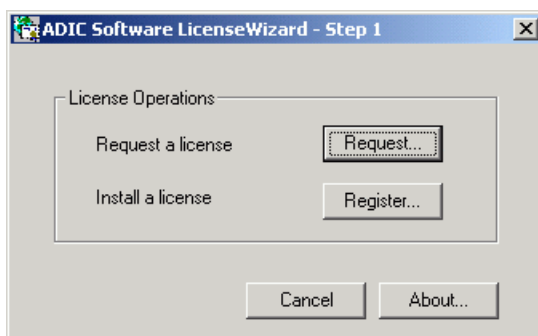

List	Operation	Description
Request	Click	Request a license string. See Figure 181 on page 233.
Register	Click	Install the license string. See Figure 185 on page 236.
Cancel	Click	Clear the dialog and exit.
About	Click	Provide a brief description of the license wizard. See Figure 180 on page 233.

Figure 180 About License



At the first step of License request process the customer must choose the license request file.

Figure 181 License Request File

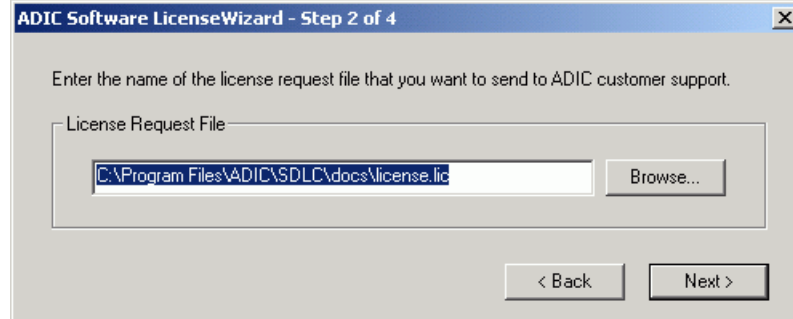

List	Operation	Description
License Request File	Enter	The license request file name and path. The default file is <%SystemDrive%\Program Files\ADIC\SDLC\docs\license.lic
Browse	Click	Browse for the license request file.
Back	Click	Return to the previous dialog
Next	Click	Open the next dialog pane.

The next step is the Licensing Review.

Figure 182 Licensing Review

List	Operation	Description
Product Information	Supplied	Scalar DLC version is shown here.
Product Serial #	Enter	Scalar DLC serial number.
Customer Information	Supplied	Customer information obtained from Scalar DLC Database.
Company	Supplied	Company name.
Address	Supplied	Company address.
Contact	Supplied	Contact person.
Email	Supplied	Contact email address.
Phone	Supplied	Contact phone number.
Fax	Supplied	Contact fax number.
ADIC mailing list	Supplied	Add user to the ADIC mailing list.
Support Information	Supplied	Windows NT/2000/2003 Support Information.
Operating System	Supplied	Operating system version.
Service Pack	Supplied	Service pack currently installed.
Libraries	Supplied	Licensed ADIC libraries.
Back	Click	Return to the previous dialog.
Clear	Click	Clear all editable fields.
Save File Only	Click	Save license request to file and exit. See Figure 184 on page 235.
Send Email	Click	Send license request to ADIC via email. See Figure 183 .



CAUTION

Changing the editable fields is possible, but not recommended.

Figure 183 Send License via Email

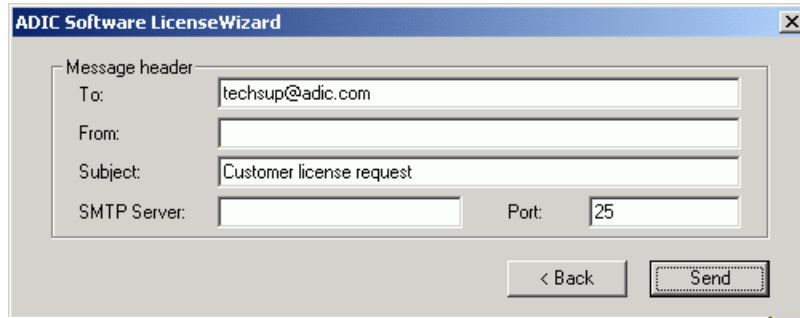

List	Operation	Description
Message header	Supplied	Email parameters for sending email.
To	Enter	Email receiver. <i>ADIC technical support</i> is the default.
From	Enter	Sender email. <i>Contact email</i> is the default.
Subject	Enter	Email subject. <i>Customer license request</i> is the default.
SMTP server	Enter	SMTP server name.
Port	Enter	SMTP port.
Back	Click	Return to the previous dialog
Send	Click	Send email and finish. See Figure 184 .



CAUTION

Changing the editable fields is possible, but not recommended.

Figure 184 Licensing Before Installation



Installing License

After obtaining the License string from ADIC Technical support, perform the following:

- Step 1** Before applying the license make sure the Scalar DLC service is *stopped*.
- Step 2** Launch ADIC Licensing through **Start > Programs > ADIC Distributed Library Controller > ADIC Licensing**. See [Figure 179](#) on page 232.
- Step 3** Press **Register**. The Register wizard starts with the Authorization string dialog. See [Figure 185](#).
- Step 4** Follow the steps as they are described.
- Step 5** Restart the Scalar DLC supervisor for the changes to take effect.

Figure 185 Authorization String

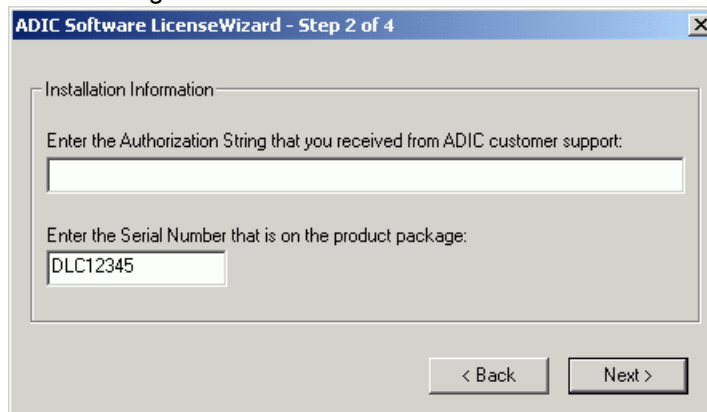

List	Operation	Description
Authorization string	Enter	The authorization string must be entered here.
Serial number	Enter	The Scalar DLC serial number must be entered here.
Back	Click	Return to the previous dialog.
Next	Click	Open the next dialog pane. See Figure 186 .

Figure 186 Time-based License

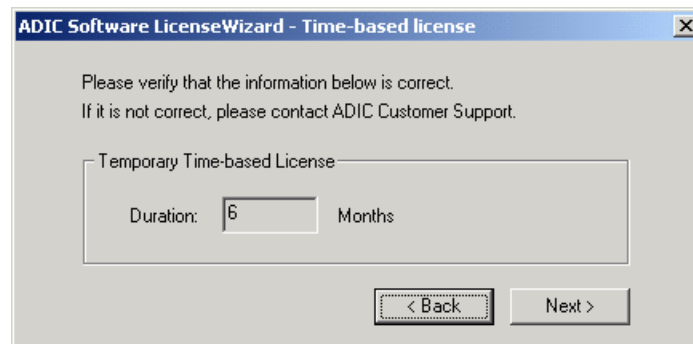

Note

Although the typical ADIC license is permanent, it may be only time-based. This means that after the specified period of time, the Scalar DLC software will not function unless a new license is installed.

List	Operation	Description
Duration	Supplied	The Scalar DLC software duration period (months).
Back	Click	Return to the previous dialog.
Next	Click	Open the next dialog pane. See Figure 187 .

Figure 187 Finishing License

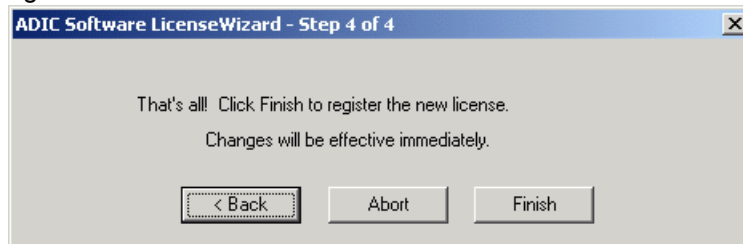

Note

When the license is installed, the tape device must be online. Otherwise, the license will not be applied.



CAUTION

After the license string is installed, restart the Scalar DLC service for the changes to take effect.

Cluster License

Although there is no special license wizard for Scalar DLC Failover solution, a special sequence must be performed in order to install the license for the cluster.

- Step 1** Start Scalar DLC software on Node1. Request the license. Refer to [Obtaining License](#) on page 232.
- Step 2** Send the license request file to ADIC customer support. The authorization string (`string1`) will be returned.
- Step 3** Change the active node to Node2. Request the license here as well. Refer to [Obtaining License](#) on page 232.
- Step 4** Send the license request file to ADIC customer support. The authorization string (`string2`, different from `string1`) will be returned.
- Step 5** Register the license on Node1 with the `string1`. Refer to [Installing License](#) on page 236. Take the Scalar DLC supervisor *offline*, so the active node will be changed to Node2.
- Step 6** Register the license on Node2 with the `string2`. Refer to [Installing License](#) on page 236. Take the Scalar DLC supervisor *offline*, so the active node will be changed back to Node1.



Application Notes

This topic contains the following important information.

- [Glossary](#) on page 239 provides the glossary of significant terms.
- [Element Addressing](#) on page 244 describes the element addressing.
- [Application Notes](#) on page 245 shows the media and element types and enlists the error codes.

Glossary

Table below contains all specific terms used throughout the document and their brief explanation.

Table 28 Terms

Term	Explanation
Adapter	The hardware (card) for the SCSI or FC connection. Also required for the connection between the Scalar DLC host and the tape device. The adapter for the library connection operates in the <i>Initiator</i> mode. The client connection requires that the adapter(s) operating mode should be <i>Target</i> .
admin	The default Scalar DLC user who has an <i>Admin</i> access level.
Admin	The Scalar DLC user level with the greatest access rights. Also refer to <i>Administrator</i> .
Administrator	<i>Local Administrator</i> or <i>Domain Administrator</i> is the access right granted to the Windows 2000/2003 user. Contact the network administrator for details.
aisle	Same as <i>Robot</i> .
atac	The default Scalar DLC user with <i>CE</i> access level. Cannot be removed.
ATAC	ADIC Technical Support Center. The customers should contact ATAC in case of any problems.
Barcode	The label on cartridge where its name (volser) is written. Also usually contains the cartridge media type (for example, 3590).
Barcode reader	The built-in robotic device that scans the cartridge barcode.

Table 28 Terms (Continued)

Term	Explanation
Cartridge	Typically means <i>Data cartridge</i> .
CE	The Management GUI user level with the rights of ticket manipulation. Also refer to <i>Customer engineer</i> .
Clean pool	A logical set of cleaning cartridges (single media type only). It should be assigned to the appropriate drive to perform the drive cleaning operation, either manually or automatic.
Cleaning cartridge	The tool that has overall dimensions of a data cartridge that performs the drive cleaning operations.
Cleaning medium	Same as <i>Cleaning cartridge</i> .
Client	Either a person or backup application that is connected to the Scalar DLC via the client interface. Each client is assigned to a logical library, and from the client side this library appears as the actual device.
Client interface	The method of the client-send and client-received commands interpretation. Three client interfaces are available: <i>SCSI</i> , <i>DAS</i> , and <i>ROBAR</i> .
Command log	The list of commands executed by the <i>Physical library</i> .
Customer engineer	A person (usually from ATAC) that is responsible for the service maintenance.
dasadmin	The application provided by ADIC that represents the client part of the <i>DAS</i> interface, as well as the Scalar DLC software that represents the server part.
DAS	Distributed Automatic media library Server. A widely used client interface. Requires only valid TCP/IP connection between server (Scalar DLC host) and client PC.
Data cartridge	The data carrier. Depending on the media type, it provides a different amount of data (for example, LTO cartridge can hold up to 10 Gb).
Dismount	The operation of moving a single cartridge from drive to a home position. Some drive models require <i>Unload</i> to be executed before this operation.
Drive	The slot designed to temporary store a data cartridge and execute read/write operations from/to it.
Drive slot	Same as <i>Drive</i> .
Dual-aisle	The physical library with two robots. Contains at least one storage tower that can be accessed by both robots.
EIF, E/I/F	Export/Import Frame. Same as <i>Mailbox</i> .
Eject	The operation of move the cartridge(s) from storage or drive to <i>Mailbox</i> . Each cartridge will be either <i>ejected</i> or <i>unloaded</i> .
Element	Same as <i>Slot</i> .
Error log	The list of errors that the <i>Physical library</i> has encountered.
Event	Any action performed by the Scalar DLC, for example, “move medium” or “start the software service”. Every event is shown in the <i>Scalar DLC log</i> .

Table 28 Terms (Continued)

Term	Explanation
Event notification	When the specific event has occurred, the Scalar DLC can send an appropriate message to the customer via email or Management GUI. The message format depends on the appropriate <i>Event rule</i> .
Event rule	A pre-defined pattern that selects the specific event from all actions that have occurred. It can also send a notification to the specified destination. See also <i>Event</i> and <i>Event notification</i> .
Export	Same as <i>Eject</i> .
FC	Same as <i>Fibre Channel</i> .
Fibre Channel	An optical connection operating with the SCSI protocol. Currently has the largest carrying capacity among all other interfaces and virtually no distance limitations. Also refer to <i>SCSI</i> .
Generic Mount	The operation of loading a single cartridge into the first free drive of the appropriate type. Also refer to <i>Mount</i> .
GUI log	The list of notification messages visible to all users who are currently logged on the Management GUI. No archive available.
HCC/MVS	Also called HACC/MVS. Host (Automatic) Control Component / Multiple Virtual Storage. Some installations use this software solution on MVS platforms in addition to the ROBAR client.
Home position	The slot (typically a storage slot) where the cartridge will be automatically returned after <i>Insert</i> and <i>Dismount</i> commands are executed.
I/O unit	Input/Output unit. The device that contains a pack of insert/eject slots which can be accessed from outside the library only as a single unit. The physical library usually contain several I/O units.
Import	Same as <i>Insert</i> .
Insert	The operation that moves the cartridge(s) from the insert/eject area to the storage area. Each cartridge is placed into the home position.
Insert/eject area	All available insert/eject (mailbox) slots in the library.
Insert/eject slot	The slot that serves as a temporary storage for a cartridge that should be either placed into the library (insert operation) or removed from it (eject operation).
Interface adapter	Same as <i>Adapter</i> .
Library	<ol style="list-style-type: none"> 1 Refer to <i>Logical library</i>. 2 Refer to <i>Physical library</i>.
Library log	Refer to <i>Command log</i> and <i>Error log</i> .
Linear shelf	Same as <i>Linear storage</i> .
Linear storage	A device that consists of storage slots. If the library is dual-aisle, each linear storage device can be accessed by one robot only.

Table 28 Terms (Continued)

Term	Explanation
Logical library	The logical representation of the <i>Physical library</i> (or its part) as it can be seen by the customer via the <i>Client interface</i> .
LSCI coordinate	The element (slot) physical coordinate in LSCI format (device-section-row-column-position).
LUN	Logical Unit Number. Each LUN can represent a device for the client. That means after the configuration is complete the SCSI client will see the assigned logical library as the SCSI device connected to a certain LUN.
Mailbox	The logical set of insert/eject slots. Should be created in the <i>Logical library</i> to represent its <i>I/O unit</i> .
Mailbox area	Same as <i>Insert/eject area</i> .
Mailbox slot	Same as <i>Insert/eject slot</i> .
Media domain	This characteristic indicates the cartridges that can be stored into the same storage slot even if their media type is different (for example, both NCTP and 3590 cartridges are of the 'half-inch' domain). And vice versa: the media domain characteristic indicates slots that could be the possible container for the cartridge.
Media type	The cartridge characteristic that indicates its dimensions, capacity, etc.
Medium, media	Same as <i>Cartridge</i> .
Mount	The operation of loading a single cartridge into a drive.
Move	The operation of getting the cartridge from a target slot and putting it to the destination slot. This operation can change the cartridge home position.
Multi-port adapter	Some models of the SCSI adapters have more than one port that can be used to accept commands. The Management GUI shows any two-port adapter as two single-port adapters, although it is physically single hardware.
Notification	Same as <i>Event notification</i> .
Offline cartridge	The cartridge that has been removed from the library and remains currently only in the archive list.
Partition	The continuous range of slots that are of the same type (for example, Generic DLT). A set of partitions must be assigned to the <i>Logical library</i> .
Physical library	The automated robotic device that serves as a cartridge store. It contains a large number of slots where the cartridges can be inserted, and where the robotic accessory (manipulator) moves cartridges from one slot to another.
Port	Represents the SCSI <i>Adapter</i> in the Management GUI because every adapter has the port that is configured to accept commands. See also <i>Multi-port adapter</i> .
ROBAR	ROBotic ARchive. Requires valid TCP/IP connection between server (Scalar DLC host) and client PC.

Table 28 Terms (Continued)

Term	Explanation
Robot	The automatic system that consists of a manipulator that is moving back and forth as well as up and down on the rails to access all library slots and move the cartridges from/to them. Also contains a <i>Barcode reader</i> to identify the accessed cartridges.
Robotic accessor	Same as <i>Robot</i> .
Rule	Same as <i>Event rule</i> .
Scalar DLC log	The list of notification messages that describe the Scalar DLC working process. Can be viewed from outside even when the Scalar DLC software itself is stopped.
Scanner	Same as <i>Barcode reader</i> .
Scratch cartridge	The data cartridge that is considered as empty and ready-to-write.
Scratch medium	Same as <i>Scratch cartridge</i> .
Scratch pool	A logical set of scratch cartridges (single media type only). Each data cartridge assigned to the scratch pool will be considered as <i>scratch</i> .
SCSI	Small Computer System Interface. A widely used interface with the large carrying capacity. Requires additional hardware (SCSI adapter(s), cables, etc.) and software (SCSI Target Mode driver).
SCSI coordinate	Element (slot) physical coordinate in SCSI format (0 - 65535).
Single-aisle	The <i>Physical library</i> with a single robot.
Single-port adapter	The <i>Adapter</i> that contains a single port to send/receive commands.
Slot	The part of the physical library that receives a cartridge. There are three groups: <i>Storage slot</i> , <i>Insert/eject slot</i> (mailbox), and <i>Drive</i> .
Storage area	All available storage slots in the library.
Storage slot	The slot is designed to keep a cartridge as long as it is required.
Storage tower	A device that consists of storage slots. Its capacity is larger than of the linear storage (for example, DLT-tower contains up to 18 rows of slots, and DLT-shelve only 6). If the library is dual-aisle, there always is at least one storage tower that can be accessed by both robots and therefore called shared. However the tower can be non-shared, too.
Tape	A synonym for <i>Cartridge</i> . All tapes are cartridges, however some cartridges are not tapes.
Tape device	Same as <i>Physical library</i> .
Target	Depending on the adapter properties, each Target has a number of LUNs. That means each Target can be connected to this number of the devices, or represent such a number of connected devices to the client as well.

Table 28 Terms (Continued)

Term	Explanation
Ticket	Mostly a report issue. It is usually created by a customer who encounters a problem and calls for ATAC help.
Unload	The operation of ejecting the cartridge from drive to prepare it for a move. Most Scalar drives execute this command automatically.
User	A person that can log on the Scalar DLC Management GUI and monitor the commands to execute or perform certain operations manually. Different users may have different access levels and/or different rights. Also refer to <i>Admin</i> and <i>Customer engineer</i> .
Volser	The cartridge name (from “volume serial number”) as shown to the customer. Can also indicate the cartridge type (data/cleaning). The optical disks acting as two-side cartridges are represented with two volsers.

Element Addressing

The slots in the tape libraries are mapped to the SCSI elements of physical library by the Scalar DLC physical library object. In the single-aisle libraries, the mapping is identical to the original picture.

Table 29 Element Mapping (Single-aisle libraries)

Section	Robot1 Start Coordinate	Robot2 Start Coordinate	Scalar DLC Start Physical Coordinate
I/E	16	None	16
Drive	256	None	256
Storage	4096	None	4096

Figure 188 Element Addressing (single-aisle library)

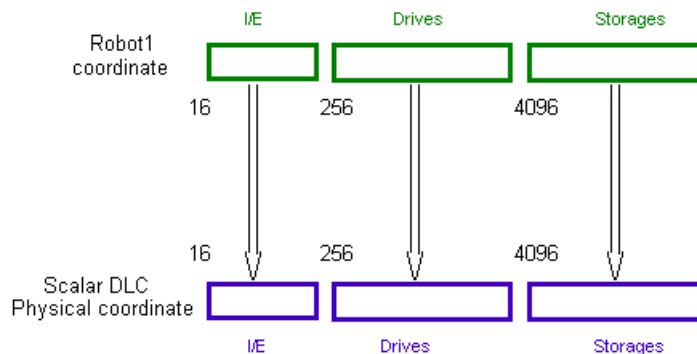

In the dual-aisle libraries the picture is much more complicated.

Table 30 Element Mapping (Dual-aisle libraries)

Section	Robot1 Start Coordinate	Robot2 Start Coordinate	Scalar DLC Start Physical Coordinate
I/E	16	None	1024 (Robot1 I/E)
	None	16	2048 (Robot2 I/E)
Drive	256	None	4096 (Robot1 drives)
	None	256	8192 (Robot2 drives)
Storage	4096	None	32768 (Robot1 storage)
		4096	16384 (shared storage)
	None		49152 (Robot2 storage)

Figure 189 Element Addressing (dual-aisle library)

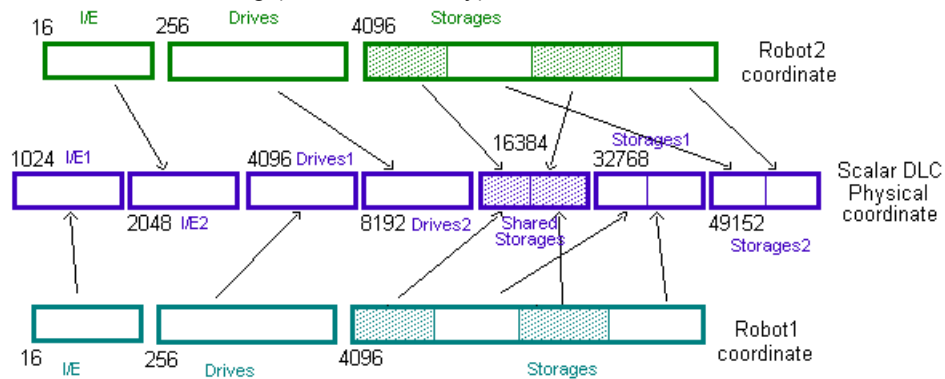

The Management GUI also indicates the LSCI coordinates used by ROBAR and (sometimes) DAS software.

The LSCI coordinates consists of 5 character pairs. The first four characters signify the 'name' or the number of the device. The third pair of characters signifies the column in which the position is located. The fourth pair of characters signifies the row of the position and the last two characters show the position in this row.

These coordinates are mapped from the coordinates of the physical library by the following way:

- Device type and number (four symbols): for example, LW01 means 'storage shelve number 1', D006 means 'drive number 6', etc.
- Column-row-position (six digits): for drives always 000000, for other types of slots something like 011006 or 120804.

Example: the LSCI coordinate "LW02060210" means "a slot that can be found at storage shelve 2, rack 6, column 2, position 10".

Application Notes

This section holds various supplemental information concerning different parts of the Scalar DLC software and clients as well.

- [Media Types](#) on page 246.
- [Storage Types](#) on page 247.

- [Mailbox Types](#) on page 248.
- [Drive Types](#) on page 249.
- [Error Codes](#) on page 251.

Media Types

The Scalar DLC software and the client applications recognizes used media in different ways. Refer to [Table 31](#).



Note

The asterisk (*) means the medium is supported by the **Scalar 1000** library. The plus (+) means the medium is supported by the **Scalar 10K** and **Scalar 10K DA** libraries (this is actually one tape library but two models: single- and dual-aisle).

Table 31 Media Types

Media	Manufacturer	Description	Media Domain	Media Type			Used in Library
				Scalar DLC	DAS	AMU	
3480	3M	0.5" tape	Half-inch	3480	3480	C0	*
3490	3M	0.5" tape	Half-inch	3480	3480	C0	*
3490E	3M	0.5" tape	Half-inch	3490E	3480	C0	*
NCTP	Philips	0.5" tape (Philip new compatible product)	Half-inch	NCTP	3480	C0	*
DLT Compac Tape III	Digital	Digital Linear Tape	DLT	DLT III	DECDDL	C1	*
DLT Compac Tape IV	Quantum	Digital Linear Tape	DLT	DLT IV	DECDDL	C1	* +
DLT Compac Tape III XT	Maxell	Digital Linear Tape	DLT	DLT IIIXT	DECDDL	C1	*
Super DLT	Quantum	Digital Linear Tape	DLT	SDLT	DECDDL	C1	* +
3590	3M	0.5" tape (NTP - New tape product)	Half-inch	3590	3590	C2	*

Table 31 Media Types (Continued)

Media	Manufacturer	Description	Media Domain	Media Type			Used in Library
				Scalar DLC	DAS	AMU	
3590E	3M	0.5" tape (Condor 3590, double capacity)	Half-inch	3590E	3590	C2	*+
LTO 1	Ultrium	LTO L1	LTO	LTO	LTO	C3	* +
LTO 2	Ultrium	LTO L2	LTO	LTO 2	LTO	C3	* +
LTO 3	Ultrium	LTO L3	LTO	LTO 3	LTO	C3	+
Super DLT II	Quantum	Digital Linear Tape	DLT	SDLT II	DECDLT	C5	*
3592 RW	IBM	0.5" tape read/write	Half-inch	3592 R/W	3592 R/W	C7	+
3592 RW short	IBM	0.5" tape read/write, short	Half-inch	3592 short R/W	3592 R/W	C7	+
3592 WORM	IBM	0.5" tape write once / read many	Half-inch	3592 WORM	3592 WORM	C8	+
3592 WORM short	IBM	0.5" tape write once / read many, short	Half-inch	3592 short WORM	3592 WORM	C8	+
SONY AIT	Sony	8mm tape	8mm	AIT	8MM	V1	* +
SONY AIT2	Sony	8mm tape	8mm	AIT	8MM	V1	* +
SONY AIT3	Sony	8mm tape	8mm	AIT	8MM	V1	* +

Storage Types

The different storage elements holds different media. Refer to [Table 32](#) on page 248.



Note

The asterisk (*) means the storage slot is supported by the **Scalar 1000** library. The plus (+) means the storage slot is supported by the **Scalar 10K** and **Scalar 10K DA** libraries (this is actually one tape library but two models: single- and dual-aisle).

Table 32 Storage Types

Storage Name	Manufacturer	Loaded Media (Scalar DLC type)	Used In Library
Generic DLT	ADIC	<ul style="list-style-type: none"> • DLT III • DLT IV • DLT IIIXT • SDLT • SDLT II 	* +
Generic 8mm	Sony	<ul style="list-style-type: none"> • AIT 	* +
LTO	IBM	<ul style="list-style-type: none"> • LTO • LTO 2 • LTO 3 	* +
Generic half-inch	ADIC	<ul style="list-style-type: none"> • 3480 • 3490E • 3590 • 3590E • NCTP • 3592 RW • 3592 WORM • 3592 short R/W • 3592 short WORM 	* +

Mailbox Types

The different insert/eject elements holds different media Refer to [Table 33](#).



Note

The asterisk (*) means the mailbox slot is supported by the **Scalar 1000** library. The plus (+) means the mailbox slot is supported by the **Scalar 10K** and **Scalar 10K DA** libraries (this is actually one tape library but two models: single- and dual-aisle).

Table 33 Mailbox Types

Mailbox Name	Manufacturer	Loaded Media	Used In Library
Generic DLT I/E	ADIC	<ul style="list-style-type: none"> • DLT III • DLT IV • DLT IIIXT • SDLT • SDLT II 	* +
Generic 8mm I/E	Sony	<ul style="list-style-type: none"> • AIT 	* +
LTO I/E	IBM	<ul style="list-style-type: none"> • LTO • LTO 2 	* +

Table 33 Mailbox Types

Mailbox Name	Manufacturer	Loaded Media	Used In Library
Generic half-inch I/E	ADIC	<ul style="list-style-type: none"> • 3480 • 3490E • 3590 • 3590E • NCTP • 3592 RW • 3592 WORM • 3592 short R/W • 3592 short WORM 	* +

Drive Types

The different drives are recognized by the client applications in different ways. The different drives also accepts different media. Refer to [Table 34](#).



Note

The asterisk (*) means the drive is supported by the **Scalar 1000** library. The plus (+) means the drive is supported by the **Scalar 10K** and **Scalar 10K DA** libraries (this is actually one tape library but two models: single- and dual-aisle).

Table 34 Drive Types

Drive Name	Manufacturer	Drive Type			Loaded Media	Used In Library
		Scalar DLC	DAS	AMU		
HP LTO	HP	HP LTO	LTO Drive	D1	• LTO	a
IBM LTO1	IBM	IBM LTO	LTO Drive	D1	• LTO	* +
IBM LTO1 Fibre Channel	IBM	IBM LTO FC	LTO Drive	D1	• LTO	+
IBM LTO2 SCSI	IBM	IBM LTO-2 SCSI	LTO Drive	D1	• LTO • LTO 2	* +
IBM LTO2 Fibre Channel	IBM	IBM LTO-2 FC	LTO Drive	D1	• LTO • LTO 2	+
IBM LTO3 SCSI	IBM	IBM LTO-3 SCSI	LTO Drive	D1	• LTO • LTO 2 • LTO 3	+
IBM LTO3 Fibre Channel	IBM	IBM LTO-3 FC	LTO Drive	D1	• LTO • LTO 2 • LTO 3	+

Table 34 Drive Types (Continued)

Drive Name	Manufacturer	Drive Type			Loaded Media	Used In Library
		Scalar DLC	DAS	AMU		
IBM 3592	IBM	IBM 3592	IBM 3592	D6	<ul style="list-style-type: none"> • 3592 RW • 3592 WORM • 3592 short R/W • 3592 short WORM 	+
Quantum DLT 4000 with DCI	Quantum	Quantum DLT 4000	DLT (Low Profile)	DG	<ul style="list-style-type: none"> • DLT IV • DLT III • DLT IIIXT 	*
Quantum DLT 7000 with DCI	Quantum	Quantum DLT 7000	DLT (Low Profile)	DG	<ul style="list-style-type: none"> • DLT IV • DLT III • DLT IIIXT 	*
Quantum DLT 8000 with DCI	Quantum	Quantum DLT 7000	DLT (Low Profile)	DG	<ul style="list-style-type: none"> • DLT IV • DLT III • DLT IIIXT 	*
SONY AIT Drive (SDX 310)	Sony	Sony SDX 310/500	AIT drive	DM	<ul style="list-style-type: none"> • AIT 	* +
SONY AIT2 Drive (SDX 500)	Sony	Sony SDX 310/500	AIT2 drive	DM	<ul style="list-style-type: none"> • AIT 	* +
SONY AIT3 Drive (SDX 700-C)	Sony	Sony SDX 700-C	AIT3 Drive	DM	<ul style="list-style-type: none"> • AIT 	* +
3590 Magstar	IBM	IBM 3590	IBM 3590 (Magstar)	DN	<ul style="list-style-type: none"> • 3590 • 3590E 	* +
NCTP Drive	Philips	NCTP	Philips LMS (3490)	DQ	<ul style="list-style-type: none"> • NCTP 	*
3480 Drive	ADIC	Philips 3610/ADIC 8490	Philips LMS (3490)	DQ	<ul style="list-style-type: none"> • 3480 • 3490E 	*
8490 Drive	ADIC	Philips 3610/ADIC 8490	Philips LMS (3490)	DQ	<ul style="list-style-type: none"> • 3480 • 3490E 	*
SDLT 220	Quantum	Quantum SDLT 220	DLT (Low Profile)	DR	<ul style="list-style-type: none"> • DLT IV • SDLT 	* +
SDLT 320	Quantum	Quantum SDLT 320	DLT (Low Profile)	DR	<ul style="list-style-type: none"> • DLT IV • SDLT 	* +
SDLT 600	Quantum	Quantum SDLT 600	Quantum DLT	DY	<ul style="list-style-type: none"> • DLT IV • SDLT • SDLT II 	*

a. Currently used only in Scalar 100 Dell series.

Error Codes

The Error Codes described in the [Table 35](#) are used with the [Rules Tab](#) on page 179 and [ATAC Calls Tab](#) on page 189.

Table 35 Error Codes

Error Code	Description
0	No error
200	NULL
201	NULL
202	RPC problem
203	NULL
204	Unable to Recover
205	The robot is not ready (or switched off logically)
206	Request link failure
207	Invalid robot number
208	Invalid arguments
209	Invalid client name
210	Invalid request id
211	The request was canceled
212	General software failure
213	Invalid pool name in scr_info (use with scr_info only!)
214	The cartridge is in use
215	The accessor couldn't put a cartridge - inventory dst cell
216	The accessor couldn't get a cartridge - inventory src cell
217	General hardware problem
218	Physical problem with cartridge
219	Physical problem with drive
220	Unrecoverable hardware problem
221	The accessor couldn't put a cartridge and rejected it to IE station - inventory dst cell, update IE station cells
222	The source cell is empty - update src cell, retry?
223	The destination cell is full - update dst cell, retry?
224	The door was opened and closed - do a complete inventory, retry
225	The insert/eject station was opened and closed - update IE station cells, retry
226	Unexpected hardware failure - retry

Table 35 Error Codes (Continued)

Error Code	Description
227	Invalid volser
228	Invalid drive name
229	The drive is in use
230	Prowler is not active
231	Invalid area name
232	The dynamic area became full, insertion stopped
233	The drive is allocated for another client
234	The cartridge is not mounted
235	The cartridge belongs to another pool
236	The drive is in cleaning
237	Invalid pool name
238	The area is full (occurs during ejecting)
239	The drive is allocated exclusively for another client
240	One or more coordinates are wrong
241	The area is empty?
242	Barcode read error
243	The client is not authorized to make this request
244	No drive available to do generic mount
245	No available cleaning cartridge to clean the drive
246	Media type doesn't match the volser
247	Library needs teaching - need to specify actions!
248	Library is becoming ready
249	Nothing to eject
250	Open configuration failed
251	Close configuration failed
252	Create configuration key failed
253	Delete configuration failed
254	Query configuration value failed
255	Update configuration value failed
256	Out of memory
257	Invalid user name or password
258	Invalid user

Table 35 Error Codes (Continued)

Error Code	Description
259	Invalid client type
260	User can't rename himself
261	Supervisor can't create object
262	Supervisor can't update object
263	Supervisor can't remove object
264	Supervisor can't start object
265	Supervisor can't stop object
266	Search for client in database failed
267	List clients in database failed
268	Create client failed in database
269	Get client failed in database
270	Update client failed in database
271	Remove client failed in database
272	Listing of mailboxes has failed in database
273	Creating of mailbox failed in database
274	Assigning volser to mailbox failed
275	List cartridges failed in database
276	Get cartridge failed in database
277	Get property of cartridge failed in database
278	Create destination failed in NS
279	List destinations failed in NS
280	Remove destination failed in NS
281	Requested virtual library not found
282	List elements failed in database
283	Get element failed in database
284	Get element properties failed in database
285	Assign cartridge to element failed in database
286	Internal error
287	Object is not ready
288	Initialization of request failed
289	Can't query object interface.
290	Getting of mailbox failed in database

Table 35 Error Codes (Continued)

Error Code	Description
291	List physical libraries failed in database
292	Get physical library property failed in database
293	List partitions failed in database
294	Get partitions failed in database
295	Create partition failed in database
296	Mapping of virtual elements to physical failed in database
297	List media pools failed in database
298	Get media pool failed in database
299	Create media pool failed in database
300	Remove cartridge from media pool failed in database
301	Add cartridge to media pool failed in database
302	List service actions failed in database
303	List of virtual libraries failed in database
304	Create virtual library failed in database
305	Create library failed in database
306	Get property of virtual library failed in database
307	Search of notification failed in NS
308	Load history failed in NS
309	Unknown type of notification
310	Acknowledging of notification failed in NS
311	Invalid action type
312	Get template failed in NS
313	Create template failed in NS
314	List templates failed in NS
315	Remove template failed in NS
316	Get list of rules failed in NS
317	Get rule's properties failed in NS
318	Create new rule failed in database
319	Remove rule failed in database
320	List tickets failed in SCM
321	List ticket states failed in SCM
322	List ticket states entries failed in SCM

Table 35 Error Codes (Continued)

Error Code	Description
323	Get ticket context value failed in SCM
324	Add ticket state failed in SCM
325	Add ticket state value failed in SCM
326	Mark the ticket state as deleted failed in SCM
327	Context value not found in SCM
328	Find all libraries failed in configuration module
329	The volser requested is not in the client assigned volserrange
330	Deletion of mailbox has failed
331	Deletion of virtual library has failed
332	Deletion of physical library has failed
333	Deletion of partition has failed
334	Deletion of media pool in library has failed
335	Impossible to remove or change user level of last admin
336	This item already exists
337	Impossible to create ticket
338	The volser is allocated for another client
339	The library contains mailboxes
340	The library contains pools
341	The library contains partitions
342	Updating of mailbox has failed
343	Getting pool's properties has failed
344	Updating pool has failed
345	Updating partition has failed
346	Operation has failed
347	One or more clients use this library
348	Impossible to get dump
349	Impossible to get data
350	Insertion of cartridge has failed
351	Exporting to alias has failed
352	Initialization of element status has failed
353	Mount has failed
354	Dismount of cartridge has failed

Table 35 Error Codes (Continued)

Error Code	Description
355	Dismount of drive has failed
356	Control of library has failed
357	Query of library status has failed
358	Invalid destination for move operation.
359	Element is not inventoried
360	Robot could not move
361	General bus problem
362	Resource pended
363	Invalid field in CDB
364	Coordinate not found
365	No clean cartridges are available for drive
366	Move cartridge to problem box
367	Volser is ejected
368	Insert/Eject station door is open
369	Volser is unchanged
370	Volser is duplicated
371	Volser contains invalid characters
372	Move cartridge to problem box
373	Volser is allocated to another coordinate
374	The cartridge already in place
375	The cartridge is not accessible
376	Command was aborted
377	Invalid home position
378	Mismatch to use the clean media within scratch pool
379	Element is unavailable
380	The drive did not unload the cartridge
381	Cannot lock I/E station
382	Command not supported
383	The volser is already allocated
384	The drive is already allocated
385	The drive requested is not available for this client
386	A mechanical positioning error occurred

Table 35 Error Codes (Continued)

Error Code	Description
387	The accessor dropped a cartridge
388	Could not erase EEPROM
389	Could not program EEPROM
390	Cartridge in gripper at power-on
391	Component failure
392	Gripper error
393	The accessor could not move on the vertical (Y) axis
394	Could not home the vertical (Y) axis
395	The accessor could not move on the horizontal (X) axis
396	Could not home the horizontal (X) axis
397	The accessor lost power
398	Internal target failure
399	A drive did not load or unload a tape
400	Cannot lock the I/E station
401	Cannot unlock the I/E station
402	Label too short, too long or duplicate
403	Cannot read a barcode label due to scanner problem
404	Firmware error
405	Parameter list length error (Illegal Request).
406	Illegal operation code in CDB (Illegal Request).
407	Invalid element address in CDB (Illegal Request).
408	Attempt to write a read only buffer (Illegal Request).
409	Illegal LUN (Illegal Request).
410	Invalid field in Parameter List (Illegal Request).
411	Invalid parameter in Parameter List (Illegal Request).
412	Parameter data checksum failure (Illegal Request).
413	Incompatible media installed (Illegal Request).
414	Source of MOVE MEDIUM command cannot be accessor (Illegal Request).
415	Cartridge stuck in tape drive (Illegal Request).
416	Source cartridge loaded into tape drive and not accessible (Illegal Request).
417	Media type does not match destination media type (Illegal Request).
418	Invalid bit in "Identify" message (Illegal Request).

Table 35 Error Codes (Continued)

Error Code	Description
419	Incorrect LUN configuration (Illegal Request).
420	Firmware detected an internal logic failure (Illegal Request).
421	Cartridge rejected in the Insert/Eject station because it was not properly loaded (Illegal Request).
422	Cell status and barcode questionable (Illegal Request).
423	Medium removal prevented because storage element is unavailable (Illegal Request).
424	Cartridge magazine is not installed (Illegal Request).
425	Data transport device is not installed (Illegal Request).
426	Data transfer element is varied offline (Illegal Request).
427	Message received at inappropriate time (Abort error).
428	Host rejected "Identify" message sent for reselection (Abort error).
429	Message system was disabled during parity error detection on SCSI bus (Abort error).
430	Received an "Initiator Detected Error" or initiator rejected "Restore Data Pointer" (Abort error).
431	Disconnect during command processing (Abort error).
432	The command was cancelled due to a state change (Abort error).
433	Destination element full for MOVE MEDIUM command (Illegal Request).
434	Source element empty for MOVE MEDIUM command (Illegal Request).



DAS Guide

This topic provides an overview of the DAS Client software that is a part of Scalar DLC software product.

The sections are:

- [System Description](#) on page 259.
- [Commands Overview](#) on page 260.
- [DAS Commands](#) on page 263.

System Description

DAS Client software runs as an application under Windows 2000/2003, Windows NT, Unix, Windows 9x, and so forth. This is a client software product designed to provide shared access to a member of the ADIC library family by up to 50 separate clients who run from entirely separate platforms while using various media in the library system. The DAS software makes it possible for backup, document management or HSM applications to have direct access to the media in the library systems.

The library system is controlled by the Scalar DLC software. The data from the applications is sent directly to the drives. The DAS software supports a wide variety of UNIX systems, Windows NT, and Windows 2000/2003. Connection to other operating systems such as MVS, VM or Tandem has been made across another interface of the Scalar DLC.

The client software consists of a library of functions and an administration program (*dasadmin*). The software is available for various platforms. A new client requires the standard TCP/IP functions with ONC Remote Procedure Calls (RPC) support and an ANSI C compiler. The applications access the open interface (ACI).

Each client can be assigned specific access privileges to the library:

- Basic, extended, or all functions
- Drives
- Volume Serial Number (Volsers)
- Ranges of the I/O units
- Scratch pools

The installation instructions for the DAS Client software can be found in the *Scalar DLC Installation Guide*, *Installing DAS Client* section.

Starting DAS Client Software

From WinNT / Win2000 / Win2003, launch **Start > Programs > ADIC Distributed Library Controller > Scalar DLC DAS-Client**. The *dasadmin* starts immediately.

However, the *dasadmin.exe* program can be launched manually as well.



Note

If the DAS Administration Utility has been installed under the firewall connection, the main executable file is *dasadmin_fw.exe*, not *dasadmin.exe*.

Commands Overview

DAS administrator commands can be divided into four areas: Media management, DAS management, Client management, and Scratch pool management

Media Management

- Mount and dismount
- Change sides on the optical disk in the drive
- Insert and eject
- Move medium
- Inventory
- View the available media
- View the media status
- View the logical ranges for insert/eject
- Catalog or remove foreign media
- Clean the drive
- Insert and eject the cleaning cartridge
- View the element status

Refer to [Table 37](#) on page 263 for the details.

DAS Management

- Delete command
- View outstanding commands
- Send message
- Activate and deactivate barcode reading for mount, move and eject from DAS
- Shutdown Scalar DLC supervisor
- Shutdown Scalar DLC and operating system

Refer to [Table 38](#) on page 264 for the details.

Client Management

- Reserve/release a drive for a client
- Reserve/release a volser for a client
- Modify access privileges for a client
- Modify execution parameters

Refer to [Table 39](#) on page 265 for the details.

Scratch Pool Management

- Add volser(s) to the scratch pool
- Remove volser from the scratch pool
- Get volser from the scratch pool
- View scratch pool information

Refer to [Table 40](#) on page 265 for the details.

Define and Reserve

Although the DAS Client may typically access all resources of the library which is configured to it, there are situations when the access rights need to be temporarily modified.

Define means the client may access only the defined drives and/or cartridges. The defined resource could be used by several clients. *No definition* means the client can use all available resources (whole logical library).

Reserve (allocate) means only the specified client may use the reserved drives and/or cartridges. The reserved resource cannot be used by other client until the reservation is removed. *No allocation* means the client uses common resources that can be also accessed by other clients.

[Table 36](#) lists all DAS/ACI commands that use either define or reserve features (or both).

Table 36 Usage of Define and Reserve

Command	Used Define	Used Reserve
allocd	drives	drive
allocv	-	volser
carry	drive, volser	drive, volser
cellinfo	volser	-
clean	drive, volser	drive, volser
dismount	drive, volser	drive, volser
eject	volser	volser
eject2	volser	volser
eject3	volser	volser
ejectcl	volser	volser

Table 36 Usage of Define and Reserve (Continued)

Command	Used Define	Used Reserve
ejectcom	volser	volser
flip	drive, volser	drive, volser
getvolsertodrive	drive	-
getvoltoside	volser	-
insert	volser	volser
insert2	volser	volser
listd	drive	-
listd2	drive	-
listd3	drive	-
listd4	drive	-
listd5	drive	-
listv	-	volser
listv2	-	volser
mount	drive, volser	drive, volser
pausedrive	drive	drive
qvolsrange	volser	volser
scap	drive, volser	-
scr_get	volser	volser
scr_info	volser	volser
scr_insert	volser	volser
scr_mount	drive, volser	drive, volser
scr_set	volser	volser
scr_unset	volser	volser
show	drive, volser	-
show2	drive, volser	-
typelist	drive	-
typelist2	drive	-
unload	drive	-
view	volser	-
view2	volser	-
viewc	drive	-

DAS Commands

DAS commands are divided into:

- Media management
- DAS management
- Client management
- Scratch management

All these commands are called from *dasadmin*.



Note The *dasadmin* application provides a brief help by entering the *-h* option.

Table 37 Media Management

Command	Explanation
carry	moves volsers from one slot to another.
catf	catalogs foreign media.
cellinfo	displays information about devices and cartridges in the system.
clean	cleans drive.
dismount	removes a medium from a drive and returns it to its home position.
eif_conf	returns an information of logical ranges configured in the insert/eject area.
eif_info	returns an information of logical ranges configured in the insert/eject area.
eject	ejects a limited number of media from the library.
eject2	ejects media from the library.
eject3	ejects media from the library.
ejectcl	ejects used cleaning media from the library.
ejectcom	ejects media from the library completely.
flip	flips the optical disk in the drive.
getvolsertodrive	displays the configured assignment of volsers to drives.
getvoltoside	displays information on the association of volsers to an optical disk.
insert	inserts a few cartridges in the library.
insert2	inserts many cartridges, including cleaning cartridges, in the library.
inventory	checks and corrects the whole library system database.
mount	loads medium into a drive.
partinventory	checks and corrects part of the library system database.
pool_list	provides information about clean/scratch pools in the system.

Table 37 Media Management (Continued)

Command	Explanation
pool_data	provides information about volsers assigned to the given pool.
qvolstrange	displays the volser from the Scalar DLC database for a specified range.
rmf	removes foreign media from the catalog.
unload	operates the buttons on the drive (for example, unload button) by the robotics.
view	displays information from the database relating to a volser.
view2	displays information from the database relating to a volserrange.
viewc	displays information from the Scalar DLC database relating to a coordinate
volserinventory	checks and corrects part of the library system database.

Table 38 DAS Management

Command	Explanation
barcode	activates/deactivates the library barcode reader for the mount, carry, and eject commands.
cancel	deletes a command from the command queue.
email	sends the message via email.
hosttype	provides information about the type of the connected host
killamu	terminates Scalar DLC software and OS.
list	displays the DAS command queue.
list2	displays the advanced DAS command queue.
list3	provides enhanced information on executing requests
pausedas	turns dasadmin to a passive state.
pausedrive	logically turns a tape drive disable/enable.
qversion	displays the DAS and ACI version.
robhome	makes the library system inactive.
robstat	makes the library system active or queries status.
rpctest	perform quick portmapper test
shutdown	shuts down Scalar DLC
snmp	sends the message via SNMP.
switch	switches between active and passive cluster nodes.

Table 39 Client Management

Command	Explanation
allocd	drive reservation for a client.
allocv	volser reservation for a client.
listd	displays drive assignment for up to 16 drives.
listd2	displays drive assignment for up to 250 drives.
listd3	displays drive assignment for up to 250 drives.
listd4	displays drive assignment for up to 380 drives.
listd5	displays drive assignment
listf	displays foreign volsers.
listv	displays volser reservations.
listv2	displays volser reservations
scap	temporarily modifies access privileges.
scop	temporarily modifies the working parameters.
scop2	temporarily modifies the working parameters.
show	displays current access privileges and operating parameters.
show2	displays current access privileges and operating parameters.
typelist	shows all drives or specific drives with matching media type
typelist2	shows all drives or specific drives with matching media type

Table 40 Scratch Management

Command	Explanation
scr_get	displays the next available scratch volser from the scratch pool.
scr_info	displays information relating to the scratch pool.
scr_insert	inserts a cartridge and adds it to the scratch pool.
scr_mount	places the next available scratch cartridge in the drive.
scr_set	adds cartridge in the library system to the scratch pool.
scr_set_range	adds cartridges in the library system to the scratch pool.
scr_unset	changes cartridge status from scratch to unscratch.

**Note**

The configuration of scratch pools, clean pools, and insert/eject areas should be executed via the Scalar DLC Management GUI. The configuration of Define Range and Reserve Range can be done from both Management GUI and client side as well.

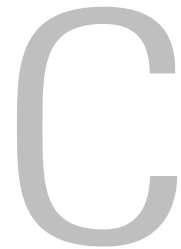

SCSI Guide

This section provides a brief overview for the Scalar 1000 and Scalar 10K Medium Changer Small Computer System Interface (SCSI) protocol, including supported commands and messages.

The topics are:

- [Installation and Configuration](#) on page 267 describes the installation and configuration order for SCSI Client.
- [General Characteristics](#) on page 268 outlines SCSI general information. It also includes:
 - [SCSI Bus](#) on page 269.
 - [SCSI Communications](#) on page 270.
 - [SCSI Message System](#) on page 271.
 - [SCSI Commands](#) on page 272.
 - [SCSI Operations](#) on page 274.

Installation and Configuration

- Step 1** Install the Scalar DLC software with the SCSI support on the server PC. Install the required drivers for the target mode. Refer to *Scalar DLC Installation Guide, Installing Scalar DLC Software* and *Installing SCSI Target Drivers* sections. The server PC requires a restart.
- Step 2** Enable appropriate SCSI target ports via the SCSI Target Port tool. Refer to [SCSI Target Port Tool](#) on page 217. The server PC may ask for a restart.
- Step 3** Start the Management GUI. Refer to [Scalar DLC Management GUI](#) on page 9. Create at least one Target object and at least one LUN. Refer to [SCSI Target Tab](#) on page 162, [Create Target](#) on page 169 and [Create LUN](#) on page 170. The created target is *not active*.
- Step 4** Create the library configuration that the client requires. Refer to [Configuration](#) on page 16. Create additional mailboxes and clean/scratch pools if necessary. Refer to [Create Mailbox](#) on page 110 and [Create Pool](#) on page 109.
- Step 5** Create a SCSI client based on the created Target and LUN, and assign it to the created logical library. Refer to [Create SCSI Client](#) on page 155. The LUN becomes *active*.



Note

Either use LUN 0 or ensure that there already is a SCSI client configured for LUN 0 of the specified target. Otherwise, even when everything is properly configured and installed, the SCSI Client cannot be activated.



CAUTION

It is strongly not recommended either assign the non-SCSI client to the same logical library, or use the library partitions as shared resources in other logical libraries with the non-SCSI client assigned. Should that be done, some SCSI features will not be available for the client, mostly because of home position restrictions used in the Scalar DLC software for non-SCSI clients.

Step 6 Install the client application on the client PC and configure it to work with the appropriate Port-Target-LUN.

Step 7 Now, the Scalar DLC software is ready to accept commands from a SCSI client.

General Characteristics

The Scalar 1000 components include:

- Control Module (CM) - a single cabinet containing an Insert/Eject station, storage cells, and tape drives. The CM uses one or two SCSI ports to connect to a SCSI host.
- Expansion Module (EM) - a single cabinet that is added to a CM to provide additional storage cells and tape drives. The Scalar 1000 can have up to three EM's.
- Operator panel - displays status and provides command entry.
- Accessor - a device that moves cartridges to and from the Insert/Eject station, storage cells, and tape drives.
- Barcode scanner - reads cartridge barcode labels to identify library volumes.

The Scalar 10K components include:

- Control Module (CM) - a cabinet that attaches to the AM. It contains storage cells, tape drives, and the library Operator LCD Panel that displays library status and provides a command entry point. The CM uses one or two SCSI ports to attach SCSI hosts.
- Accessor Module (AM) - a cabinet that contains four rack locations (Control Module, Insert/Eject stations, Tower Module, or Storage Cells), and the Accessor. Each AM can have an Expansion Module added.
- Expansion Module (EM) - a cabinet that is added to an AM or to another EM to provide additional storage cell configurations and attachment capabilities for DMs and TMs. The Scalar 10K can have up to three EM's.
- Accessor - located in the AM, it is a device that moves cartridges to and from Insert/Eject stations, storage cells, or tape drives.
- Barcode scanner - located in the AM, it is a device that teaches the system configuration, and reads cartridge barcode labels to identify library volumes.
- Drive Module (DM) - a cabinet that attaches to an AM or an EM. It contains a maximum of 48 drives.
- Tower Module (TM) - a cabinet that attaches to an AM or an EM. It contains rotating storage locations.



Note The Scalar 10K DA (dual-aisle) library is the same as Scalar 10K, however it contains two CM, two AM, two barcode readers, etc.

There are four Scalar 1000 and Scalar 10K modes of operation:

- ADIC native mode,
- EXABYTE compatibility mode,
- STK compatibility mode,
- EMASS compatibility mode.



Note The mode of operation determines how the library responds to the SCSI INQUIRY command.

The Scalar 1000 and Scalar 10K supports half inch, DLT/SDLT, LTO, and AIT tape cartridges. For the Scalar 1000 library, a storage cell cartridge capacity ranges from 118 cells in the CM and up to 1182 cells with additional EMs. For the Scalar 10K library, a storage cell cartridge capacity ranges from 700 cells in the CM to 15938 cells with additional EMs, DM, and TMs. Total capacities are dependent on the media type configurations.

Associated Documents

For the details of the SCSI operations refer to:

- SCSI Reference Manual for the Scalar 10K library.
- SCSI Reference Manual for the Scalar 1000 library.

The SCSI client should use the document that describes the data format used by his software target application. Refer to [Target](#) on page 166 and [Logical Unit Number \(LUN\)](#) on page 168 for the details.

SCSI Bus

A SCSI Bus is a shared resource that provides a pathway for exchanges between one or more hosts and their peripheral devices. A SCSI bus can be Single Ended, Differential, or Low Voltage Differential and must be terminated at both ends.

SCSI bus components are:

- SCSI initiator (host)
- SCSI target (peripheral)
- Cable connecting host and peripheral
- Bus terminators

Consider the computer system as the host and the Scalar 1000 and Scalar 10K as the peripheral.

Initiator Operation

The SCSI bus adapter card in a host computer is the initiator of SCSI operations. The host initiates commands and messages or sends data to the target. The initiator also receives messages, data, and status from the target.

Target Operation

The Scalar 1000 and Scalar 10K library target respond to control information or data from the host. The library does not:

- Generate unsolicited interrupts to the host
- Initiate its own SCSI commands
- Assert bus resets

Element Addressing

The host references source and target designations with element addresses within the library. Each element within the library has a unique address. The element addresses are established according to the firmware version of the library.

The Scalar 1000 has two firmware versions:

- Firmware earlier than Version 3.0
- Firmware Version 3.0

The addressing scheme of the Scalar 1000 depends on the firmware version that is used.

The Scalar 10K SCSI addressing scheme is:

- One Cartridge Accessor exists. Its assigned address is always 1h.
- The I/E station locations are addressed continuously from top to bottom, station by station.
- Tape drive locations are addressed from lower left to upper right, rack by rack.
- Storage element locations are addressed from the top left to lower right, column by column, rack by rack.

SCSI Communications

Scalar 1000 and Scalar 10K communications are implemented across the SCSI bus. The following paragraphs discuss the bus phases.

Bus Phases

The Scalar 1000 and Scalar 10K conforms to the bus state transition table of the SCSI-2 standard, *Phase Sequences*. Bus phases determine the type of information and direction on the interface as shown in table below.

Phase	Description
Bus Free	The Bus Free phase indicates that the bus is idle.
Arbitration	The Arbitration phase allows devices to compete for bus access.
Selection	The Selection phase allows the host initiator to select the target destination for communication.
Reselection	The Reselection phase allows the target to reconnect to the host initiator after a disconnect has occurred.

Phase	Description
Transfer	<p>The library supports asynchronous data transfer phases with differential and single ended communications. Odd parity is generated during all information transfer phases from the library. Parity is checked during all information transfer phases to the library. Parity checking can be disabled.</p> <p>Information Transfer phases include:</p> <ul style="list-style-type: none"> • The Message In/Message Out phases manage the physical path between the host initiator and target destination. Message In is a message to the host initiator, Message Out is a message to the target destination. • Command Out phase is a command from the host initiator to the target destination. • Data In/Data Out phase is either data sent from the target to the host initiator (Data In) or data sent from the host initiator to the target destination (Data Out). • Status In is a target status byte response to a host-initiated command.

SCSI Message System

The SCSI message system (Message In/Message Out) allows communication between an initiator and a target for the purpose of physical path management.

Message	Code	Description	Direction
COMMAND COMPLETE	00h	The COMMAND COMPLETE message is sent from a target to an initiator to indicate that the execution of a command is complete and valid status has been sent to the initiator.	In
SAVE DATA POINTERS	02h	The SAVE DATA POINTERS message is issued before every disconnect message following a Data In or Data Out phase. The message is not sent when disconnecting after a Command Descriptor Block (CDB) that did not transfer data.	In
RESTORE POINTERS	03h	The RESTORE POINTERS message is sent from a target to direct the initiator to continue sending data.	In
DISCONNECT	04h	The DISCONNECT message is sent by a target to inform an initiator that the present data transfer will be suspended. The target will reselect the initiator at a later time to continue the current operation.	In
INITIATOR DETECTED ERROR	05h	The INITIATOR DETECTED ERROR message is sent from an initiator to inform a target that an error has occurred. This allows the target to retry the operation.	Out
ABORT	06h	The ABORT message is sent from the initiator to the target to clear the current or pending operation. The target goes directly to the BUS FREE phase after successful receipt of this message.	Out

Message	Code	Description	Direction
MESSAGE REJECT	07h	The MESSAGE REJECT message is sent from the initiator or target to indicate that the last message received was inappropriate or not implemented.	Both
NO-OP	08h	The NO-OP message is sent from the initiator to inform the target that no message is valid in response to the target request for a message.	Out
MESSAGE PARITY ERROR	09h	The MESSAGE PARITY ERROR message is sent from the initiator to the target to indicate that one or more bytes in the last message received contained a parity error.	Out
BUS DEVICE RESET	0Ch	The BUS DEVICE RESET message is sent from an initiator to clear all commands, data, and status at the target. When the target recognizes this message, it aborts the command currently being executed, proceeds to the BUS FREE state, and executes a hard reset.	Out
IDENTIFY	80h or C0h	The IDENTIFY messages are sent either by the initiator or by the target to establish (or re-establish) the logical connection path between an initiator and target for a particular logical unit. The Scalar 1000 and Scalar 10K libraries only support a logical unit of 0.	Both

SCSI Commands

The topic provides information on Device Commands, SCSI Commands Format, and SCSI Command Status Byte.

Device Commands

Table below shows the SCSI medium changer commands that are supported by the Scalar 1000 and Scalar 10K libraries.

Operation code	Command
07h	INITIALIZE ELEMENT STATUS
E7h	INITIALIZE ELEMENT STATUS WITH RANGE
12h	INQUIRY
4Ch	LOG SELECT
4Dh	LOG SENSE
15h	MODE SELECT
1Ah	MODE SENSE
A5h	MOVE MEDIUM

Operation code	Command
2Bh	POSITION TO ELEMENT
1Eh	PREVENT/ALLOW MEDIUM REMOVAL
3Ch	READ BUFFER
B8h	READ ELEMENT STATUS
1Ch	RECEIVE DIAGNOSTIC RESULTS
17h	RELEASE
03h	REQUEST SENSE
B5h	REQUEST VOLUME ELEMENT ADDRESS
16h	RESERVE
01h	RE-ZERO
1Dh	SEND DIAGNOSTIC
B6h	SEND VOLUME TAG
00h	TEST UNIT READY
3Bh	WRITE BUFFER

SCSI Command Format

The SCSI command format follows the SCSI-2 and SCSI-3 standard. Table below describes the CDB fields that are common to all commands.

Command	Description
Logical Unit Number	The library has a single Logical Unit Number (LUN). The library always appears as LUN 0. If the LUN is specified in the IDENTIFY message, the LUN field in the CDB is ignored by the library.
Reserved	The word Reserved or Rsvd refers to a field defined by the SCSI standard as 0. The library checks the field for 0. If the field is not 0, the library returns Check Condition status with a sense key of Illegal Request.
Control Byte	The vendor unique portion of the Control Byte is defined in the specific command.
Not Implemented	This description indicates that the field is a SCSI standard but is not supported by the library.

SCSI Command Status Byte

Both the Scalar 1000 and Scalar 10K enter the status phase once per command, unless a retry is requested by the initiator. Table below describes the library return status bytes.

Status	Value	Description
Good	00h	The library successfully completed the command.
Check Condition	02h	An error condition occurred during command processing. The REQUEST SENSE command responds with detailed error information.
Busy	08h	The target is busy. This status is returned when the device is unable to accept a command from an otherwise acceptable initiator. The initiator should reissue the command at a later time.
Reservation Conflict	18h	This status is returned by the library when a SCSI initiator attempts to access the library after it is reserved by another initiator with a RESERVE command.

SCSI Operations

The following detail Scalar 1000 and Scalar 10K SCSI communication behavior.

Parity Checking

To enable parity checking on information received by the library, set the parity bit on the Parity Page of the MODE SELECT command.

Disconnection

The library disconnects from the SCSI bus whenever a command requires a lengthy time to complete. The library receives permission to disconnect from the initiator. The initiator grants permission by:

- Selecting the library with the Attention signal.
- Sending an Identify message with the DiscPriv bit set to 1.

Once the command processing completes, the library reselects the initiator and sends the Identify message.

Resetting the Library

The library is reset by a Power-On Reset (POR) or a SCSI Device Reset.

Power-On Behavior

- The library goes to the Bus Free phase.
- The checksum of the flash EEPROM is validated.
- All library parameters are loaded with either saved or default values.
- A Power On SelfTest is performed.
- The library responds to the SCSI bus within 10 seconds of power on.

SCSI Device Reset Behavior

- The library goes to the Bus Free phase.
- All library parameters are returned to their saved or default values.
- A Self Test is performed.
- The library responds to the SCSI bus within 250 milliseconds.

Unit Attention Condition

Unit Attentions are reported under the following circumstances:

- Reset occurred.
- A firmware (microcode) update completes.
- A library door closes.
- The Insert/Eject station closes.
- Another initiator changes the Mode Parameters.
- Another initiator changes the Log Parameters.



ROBAR Guide

The ROBAR (ROBotic ARchive) software works with the Scalar DLC via the specific ROBAR interface. The ROBAR Client software is a flexible tool that works under various operating systems (Unix-based, Win9x, WinNT, Win2000, and so forth). The ROBAR interface was one of the first methods to operate the Automated Media Libraries and still remains very useful.

The ROBAR Client works with the Scalar DLC server software. Before the connection between the ROBAR Client and Scalar DLC can be established, the ROBAR Client object must be created and configured.

The sections are:

- [Installation and Configuration](#) on page 277.
- [ROBAR Commands](#) on page 278.
- [ROBAR Command Format](#) on page 280.
 - [Command Header](#) on page 280.
 - [Command Structure](#) on page 281.
 - [ROBAR Coordinates](#) on page 283.

Installation and Configuration

- Step 1** Install the Scalar DLC software with the ROBAR Client support on the server PC. Refer to *Scalar DLC Installation Guide, Installing Scalar DLC Software* section (either a Complete installation or a Custom installation with the ROBAR support selected). The server PC requires a restart.
- Step 2** Start the Management GUI. Create the library configuration that the client requires. Refer to [Configuration](#) on page 16. Create additional mailboxes and clean pools if necessary. Refer to [Create Pool](#) on page 109 and [Create Mailbox](#) on page 110.
- Step 3** Configure ROBAR interface to work with an appropriate port. Refer to [ROBAR](#) on page 156.
- Step 4** Create a ROBAR client and assign it to the created library. Refer to [Create ROBAR Client](#) on page 160.
- Step 5** Install the client application on the client PC and configure it to work with the appropriate server and port.

Example1 (for DOS or Windows-based system):

```
C:>\ Set PORT = 1010
C:>\ Set HOST = computer
```

Example2 (for Unix-like systems):

```
#PORT = 1010 export PORT
#HOST = computer export HOST
```

Step 6 If the customer uses HCC/MVS, this also must be configured in the ROBAR client settings. Refer to [ROBAR Client](#) on page 158.

Now, the Scalar DLC software is ready to accept commands from ROBAR Client.

ROBAR Commands

Table 41 ROBAR Commands

Command	Description
ACOM	Checks the communication to the Scalar DLC software and get information about the library status.
AOFF	Programs end of the Scalar DLC software.
AUTO	Switches from manual or test mode to the automatic mode.
BOF	Switches the barcode reading for the sending host off.
BON	Switches the barcode reading for the sending host on.
CLM	Clean manager status and configuration command.
CLU	Closes the flap on a drive.
DL	Changes a archive catalog entry.
EJ	Ejects data cartridges - temporary.
EJT	Ejects data cartridges - complete.
EJTC	Ejects complete - used cleaning cartridges.
FLIP	Toggles the side of a Optical Disk in an Optical Disk drive.
IN	Inserts data cartridges by a logical range.
INC	Verifies the archive with the database by a given coordinate.
INSC	Inserts clean cartridges by a logical range.
INV	Inventory of a given volser.
IVK	Inventory of a given coordinate range.
IVV	Inventory of a given volser.
KE	Moves a cartridge from drive to the home position.

Table 41 ROBAR Commands (Continued)

Command	Description
KEC	Moves a cartridge from drive to a given position.
LJB	Moves a cartridge to the I/O area of a integrated Jukebox.
MAN	Switches from automatic mode to the manual or test mode.
MO	Moves a cartridge to a drive from archive or the Insert/Eject unit.
MOCL	Initiates a drive cleaning.
MV	Moves a cartridge from archive or Insert/Eject unit to a coordinate in the archive or insert/eject unit.
ROPO	Moves the robot to the given coordinate.
ROSA	Displays and change the library status to online.
ROSO	Moves the robot to a park position and set the status to not ready.
SCH	Sends the information of the first occupied compartment to the requester.
SIN	Stops the running insert command.
SIVK	Stops the running inventory command.
SWIT	Toggles the library status passive-active.
UJB	Unloads the I/O unit of a integrated Jukebox.
ULC	Displays a archive catalog entry by a given coordinate.
ULK	Displays a archive catalog entry by a given coordinate.
ULU	Performs the robot to press button(s) on the drive.
ULV	Displays a archive catalog entry by a given volser.
UPC	Changes the archive catalog entry by a given coordinate.
UPK	Changes the archive catalog entry by a given coordinate.
UPV	Changes the archive catalog entry by a given volser.
VI	Inserts the first available Cartridge in the Insert area to the archive.
VICC	Inserts the cartridge from a given coordinate to a given target coordinate.

**Note**

The configuration of clean pools and insert/eject areas should be executed via the Scalar DLC Management GUI. Refer to [Create Pool](#) on page 109 and [Create Mailbox](#) on page 110

ROBAR Command Format

The command is a string that contains:

- Start symbol (<)
- Command header
- Command
- Command parameters
- End symbol (>)

The standard command is a single command with a single answer. There are also block commands that contain one command, some data messages, and one answer.

Also, in some special situations, Scalar DLC will distribute a notification in this command format to all partners using the ROBAR command format.

Command Header

The command header contains the following fields:

- Receiver
- Sender
- Telegram type
- Request ID

The command header format is shown in [Table 42](#).

Table 42 Command Header format

Field	Length	Value/Description		Example
Receiver	2	Name of the Receiver of the telegram.		H1
		Hx	Requester from type "Host".	
		M1	"Major HCC" only after a "Sign of Life" from Host type "HCC/MVS".	
Sender	2	A1, A2	External name of the Scalar DLC host.	A1
		Vx	Virtual host name (for VTLS) This command will only be routed to the VAMU (CentricStor).	
Telegram type	2	A00	Standard command.	A00
		Vxx	Message for the VAMU.	
Request ID	Comma + 4	0 - ZZZ Z	Sequence identifier from the command originator. Notification starts with the Prefix A.	,M085

Command Structure

The command itself contains the following fields:

- Command header
- Command
- Acknowledge
- Returned code
- System
- Robot
- Device
- Volser
- Status
- 1st param
- 2nd param
- Time stamp
- Orig. Host ID
- Orig. Request ID

The details in command format are shown in [Table 43](#).

Table 43 Command format

Field	Length	Value/Description	Example	
Command header	9	Command header with information about sender and requester (refer to Command Header on page 280).	A1H5A00, M875	
Command	4	Name of the command or NTFY for an asynchronous notification.	A01	
Acknowledge	1	Message specific response:	P	
		P		Positive (command successful)
		N		Negative (command unsuccessful)
		D		Data (message in a block command)
		E		End (end of block command)
		M		Asynchronous message ROBS
Return code	4	Error or Status message in the answer/number of the notification.	N005	
System	1 (2)	Library (if larger than 9, replaces the comma with the second digit of the system).	2	
Robot	1	Robot number for a twin robot system (1 or 2).	1	

Table 43 Command format (Continued)

Field	Length	Value/Description		Example
Device	3	Dxx	Drive name.	D0R
		0xx		
		Ixx	Logical range of the Insert/Eject unit.	
		Exx		
		Pxx		
Volser	6	Volume serial number.		GR0815
Status	2	Coordinate/cartridge type (1st byte):		MB
		C	Cleaning cartridge.	
		M	Data cartridge.	
		O	Optical Disk.	
		0	Empty (Null).	
		Coordinate/cartridge status (2nd byte):		
		B	Occupied.	
		E	Ejected.	
		M	Mounted.	
		O	Optical disk mounted other side.	
		J	Optical disk in Jukebox.	
		L	Empty.	
		1/0	Barcode reading on/off.	
1st param	8	First parameter (mainly the source coordinate)		01010101
2nd param	8	Second parameter (mainly, the target coordinate)		00000Z01
Time stamp	9	Actual Day, hour, minute and seconds used for synchronization (ROSA)		26/211501
Orig. Host ID	2	Original Host ID in a HCC/MVS Major-Minor Complex		H7
Orig. Request ID	4	Original Host request ID in a HCC/MVS Major-Minor Complex		0815

The following example represents the typical ROBAR command.

```
<A1H5A00,0010,MO , , ,1,2,D0R,GR0012, 1,02321810, ,26/
211032,H1,0815>
```

Most ROBAR commands return an answer string that has the same structure as the command string. The answer string is returned whether the command is executed successfully or not.

ROBAR Coordinates

For all physical positions in the system, the Scalar DLC software provides a signification coordinate. With the help of this coordinate, the Scalar DLC can compute the physical position. These are LSCI coordinates (the Scalar DLC database contains a coordinate decoder and uses the LSCI coordinate system as well as SCSI coordinates, and others). Refer to [Element Addressing](#) on page 244.

Additionally, for the Insert/Eject unit, Drives, Jukebox, and Problem box, the ROBAR interface uses special coordinates.

Table 44 ROBAR Coordinates

Area	Description	Example
Storage area	typical LSCI coordinate - device, column, row, position	01010101 (device 1, column 1, row 1, position 1)
Insert area	coordinate starts with 0001 followed by row and position	00010510 (row 5, slot 10)
Eject area	coordinate starts with 0002 followed by row and position	00020608 (row 6, slot 08)
Foreign Mount area	coordinate starts with 0003 followed by row and position	00030701 (row 7, slot 01)
Drive/ Jukebox	coordinate starts with 0000 followed by the drive address/name and 01	00000F01 (drive addr. 0F) 0000ZQ01 (drive name ZQ)
Problem box	coordinate starts with 000000 followed by number of the problem box	00000001 (problem box 1)

Index

A	
Associated Documents	1

C	
Command Line Interface	8
Configuration	16, 87
Additional	23
Create User	23
Email Notifications	24
Installing New Slots	25
Update ATAC Settings	24
Advanced	18
Assign Drives to Cartridges	20
Assign Partitions to a Library	19
Configure Additional Libraries	23
Configure Aliasing	22
Configure Clean Manager	22
Create a Logical Library	19
Create Clean Pool	21
Create Client	19
Create Mailbox	19
Create Partitions	18
Create Scratch Pool	21
Define Drives and Cartridges	23
Initialize the Logical Library	20
Inserting New Media	20
Mark Cleaning Cartridges	21
Rescan SCSI Bus	18
Reserve Drives and Cartridges	22
Automatic	17
Clients	134
Create DAS client	144
Create ROBAR Client	160
Create SCSI Client	155
DAS Client	135
DAS Client Aliasing	143
DAS Client Define Drives	140
DAS Client Drives	138
DAS Client Properties	136
DAS Client Reserve/Define Volsers	142
DAS Client Volsers	141

DAS Interface	135
ROBAR Client	158
ROBAR Interface	156
SCSI	146
SCSI Client	147
SCSI Client Drives	152
SCSI Client I/E Slots	153
SCSI Client Mode	150
SCSI Client Properties	148
SCSI Client Storages	154
Database Management	27
Archive Database	28
Backup Database Manually	27
Compact Database Manually	28
Restore Database from Backup	28
Restore Database from File	28
Schedule Database Backup	27
Schedule Database Compact	27
Schedule Transaction Logs Backup	27
Set Up Database Backup Mode	27
Logical	88
Assign Media to Pool	98
Assign Partition	108
Assign Slots to Mailbox	100
Cartridge	94
Create Library	107
Create Mailbox	110
Create Pool	109
Drive	104
Drive Properties	104
Drive Statistics	106
Library	89
Library Properties	89
Library Resource	91
Library Statistics	92
Mailbox	99
Mailbox Slot	102
Partition	93
Pool	97
Storage Slot	101
Manual	18
Operating the Tape Library Doors	26
Front Door	26

I/E Station Door	26	History Tab	179
Physical	112	Monitoring Tab	176
Create Partition	127	Queue Tab	174
Drives	126	Rules Tab	179
Library	113		
Library Properties	113	G	
Library Statistics	117	<hr/>	
Mailboxes	125	Glossary	239
Media Rules	115	Graphical User Interface	8
Offline Cartridge	121	GUI Tabs	61
Partition	119	GUI Tabs Structure	68
Robot	118		
Storage Slots	124	I	
SCSI Target	162	<hr/>	
Create LUN	170	Installation	9
Create Target	169		
LUN	168	L	
Port	164	<hr/>	
Target	166	Library Tab	71
Users	128	Licensing	232
Create User	132	Cluster License	237
User	131	Installing License	236
Configuration Tab	87	Obtain License	232
Clients Tab	134	Standard License	232
Logical Tab	88	Logical Library	71
Physical Tab	112	Cartridges	76
SCSI Target Tab	162	Cartridge State	78
Users Tab	128	Home Position	79
Contact ADIC	2	Move Cartridge to Element	80
		Drives	85
D		Library	73
<hr/>		Library Diagnostics	74
DAS		Random Mount Test	76
commands	263	Random Move Test	75
commands overview	260	Library Properties	73
client management	261	Mailbox	84
DAS management	260	Pool	82
media management	260		
scratch pool management	261	M	
define	261	<hr/>	
reserve	261	Main Menu	30
start	260	Connection	31
system description	259	Extended Service	54
		Connect to RMU	56
E		Registration Information	55
<hr/>		View Log	57
Element Addressing	244	Help	60
LSCI	245	Screen Refresh	31
SCSI	244	Wizards	32
Events	173	Assign Partitions	38
Acknowledge	178	Create Configuration	32
History	179	Create Rule	45
Monitoring	176	Create Ticket	40
Queue	174		
Rules	179	N	
Events Tab	173	<hr/>	
Acknowledge Tab	178	Notes	245

Drive Types	249
Mailbox Types	248
Media Types	246
Storage Types	247

R

Requirements	
Failover Solution	6
PC	5
Tape Library	7
Firmware	7
Operating Mode	7
ROBAR client	
installation and configuration	277
ROBAR command format	
command header	280
command structure	281
ROBAR commands	278
ROBAR coordinates	283

S

Scalar DLC Management GUI	
Browser Applet	14
Firewall and Proxy Issues	15
Browser Pre-Installation	11
Java Plug-In	14
Remote	13
Resizing Windows and Panes	10
Scalar DLC Manager Application	15
SCSI	
Client Installation and Configuration	267
general characteristics	268
SCSI bus	
element addressing	270
initiator operation	269
target operation	270
SCSI commands	
device commands	272
SCSI command format	273
SCSI command status byte	273
SCSI communications	
bus phases	270
SCSI message system	
SCSI operations	274
disconnection	274
other SCSI functionality	
unit attention condition	275
parity checking	274
resetting the library	274
power-on behavior	274
SCSI device reset behavior	274
Service	
Cluster	198
Diagnostic	187
Logs	183

Command Log	184
Error Log	186
Send Log via Email	185
Operator Panel	195
SNMP	199
Agents	200
Security	203
Traps	201
Service and Maintenance Alerts	8
Service Tab	183
ATAC Calls Tab	189
Cluster Tab	198
Diagnostic Tab	187
Logs Tab	183
Operator Panel Tab	195
Symbols	1
System Description	3

U

Utilities	
Cluster Configurator	219
Database	206
Backup	207
Compact	212
Extended Mode	209
Restore	214
Save	216
Log Viewer	221
Problem Report	220
SCSI Target Port Tool	217
Trace Manager	226
Trace Viewer	230

