

# Scalar® 100 User's Guide

---

ADVANCED DIGITAL INFORMATION CORPORATION

Copyright © 2002-2006 ADIC

The information contained in this document is subject to change without notice.

This document contains proprietary information which is protected by copyright. All rights are reserved. No part of this document may be reproduced, modified, distributed, or translated to another language without prior written consent of ADIC.

ADIC USA  
11431 Willows Road NE  
Redmond, Washington  
98052-4952  
Tel.: 1-800-336-1233  
Fax: 1-425-881-2296

This document may describe designs for which patents are pending, or have been granted. By publishing this information, ADIC conveys no license under any patent or any other right.

ADIC shall not be liable for errors contained herein or for incidental or consequential damages (including lost profits) in connection with the furnishing, performance or use of this material whether based on warranty, contract, or other legal theory. ADIC makes no representation or warranty with respect to the contents of this document and specifically disclaims any implied warranties of merchantability or fitness for any particular purpose. Further, ADIC reserves the right to revise or change this document without obligation on the part of ADIC to notify any person or organization of such revision or change.

Every effort has been made to acknowledge trademarks and their owners. All trademarks within this document are the property of their respective owners. Trademarked names are used solely for identification or exemplary purposes, and any omissions are unintentional. ADIC is a registered trademark of Advanced Digital Information Corporation.

# Contents

---

## 1 About This Guide and Your Product 1

|  |   |
|--|---|
| Product Safety Statements . . . . .        | 1 |
| Product Model Number . . . . .             | 1 |
| Explanation of Symbols and Notes . . . . . | 1 |
| Other Documents you Might Need . . . . .   | 2 |
| Getting More Information or Help . . . . . | 2 |

---

## 2 Description 3

|  |    |
|--|----|
| Drive Support and Related Technologies . . . . .         | 4  |
| Front Panel Components . . . . .                         | 4  |
| Front Power Switch . . . . .                             | 5  |
| Door Lock . . . . .                                      | 5  |
| Mailbox . . . . .  | 5  |
| Operator Panel . . . . .                                 | 5  |
| Back Panel Components . . . . .                          | 5  |
| Library Controller (Library Control Path only) . . . . . | 7  |
| Rear Power Switch . . . . .                              | 7  |
| Remote Management Unit . . . . .                         | 8  |
| Storage Networking Controllers (SNCs) . . . . .          | 8  |
| Drive Modules and Filler Plates . . . . .                | 8  |
| Internal Components . . . . .                            | 8  |
| Robotic System and Barcode Scanner . . . . .             | 8  |
| Tape Magazines . . . . .                                 | 9  |
| Slot Numbering . . . . .                                 | 9  |
| Drive Module Numbering . . . . .                         | 10 |
| Host Attachment . . . . .                                | 11 |
| Native Fibre Connections . . . . .                       | 11 |
| SCSI Connections . . . . .                               | 11 |

---

## 3 Setting up your Scalar 100 13

|  |    |
|--|----|
| Quick Start Guide . . . . .                      | 13 |
| Getting Started Road Map . . . . .               | 13 |
| Finding a Location . . . . .                     | 14 |
| Unpacking your Library . . . . .                 | 14 |
| Cabling Library Control Path Libraries . . . . . | 15 |
| Cabling Drive Control Path Libraries . . . . .   | 16 |

|   |    |
|---|----|
| Connecting the Power and Fibre Cables in a Drive Control Path Library . . . . .         | 16 |
| Connecting the Power and SCSI Cables in a Drive Control Path Library . . . . .          | 17 |
| Preparing the Host. . . . .   | 18 |
| Host Coordinate System. . . . .   | 19 |
| Installing a SCSI Adapter . . . . .   | 19 |
| Installing Drivers . . . . .  | 19 |
| Installing Drivers for Microsoft Windows 2000 and Windows Server 2003 Systems . . . . . | 19 |
| Installing Drivers for Microsoft Windows NT 4.0 Systems. . . . .                        | 21 |
| Verifying Communication with the Host. . . . .  | 22 |

---

## 4 Using the Optional Features 23

|   |    |
|---|----|
| Rackmounting Your Library . . . . .           | 23 |
| Installing Side Panels . . . . .              | 26 |
| Installing Casters . . . . .                  | 27 |
| Installing/Removing Drives . . . . .          | 27 |
| Installing a Drive . . . . .                  | 27 |
| Removing a Drive . . . . .                    | 28 |
| Replacing a Drive . . . . .                   | 29 |
| Installing a Secondary Power Supply . . . . . | 29 |
| Installing Bulk Load Mailbox. . . . .         | 30 |
| Removing the Standard Mailbox . . . . .       | 31 |
| Installing the Bulk Load Mailbox . . . . .    | 32 |
| Installing a Storage Column . . . . .         | 33 |
| Partitioning Your Library . . . . .           | 34 |
| Control Path. . . . .                         | 34 |
| Configuring AutoCleaning . . . . .            | 34 |
| Working with AutoClean . . . . .              | 35 |
| Enabling/Disabling AutoClean. . . . .         | 35 |

---

## 5 Using the Operator Panel 37

|   |    |
|---|----|
| Understanding the Operator Panel. . . . .             | 37 |
| Getting General Library Information . . . . .         | 38 |
| Getting Drive Status Information . . . . .            | 38 |
| Working with Buttons . . . . .                        | 41 |
| Getting Library Messages. . . . .                     | 41 |
| Getting Mailbox Status . . . . .                      | 41 |
| Menu Guidelines. . . . .                              | 43 |
| Using the Main Menu . . . . .                         | 44 |
| The Menu Tree. . . . .                                | 44 |
| Using Commands that Require an Offline State. . . . . | 46 |

---

## 6 Getting Information 47

|  |    |
|--|----|
| Viewing Library Information . . . . .                    | 47 |
| Getting Library Statistics. . . . .                      | 47 |
| Getting Firmware and Serial Number Information . . . . . | 48 |
| Getting Sensor Information. . . . .                      | 49 |
| Getting Slot Information . . . . .                       | 50 |
| Getting Tape Cartridge Information . . . . .             | 52 |

|   |    |
|---|----|
| Viewing Drive Information . . . . .     | 52 |
| Getting Logs . . . . .                  | 53 |
| Printing Logs (HyperTerminal) . . . . . | 53 |
| Getting the Command Logs . . . . .      | 54 |
| Getting Error Logs . . . . .            | 54 |
| Getting Drive Logs . . . . .            | 54 |
| Clear Log . . . . .                     | 55 |
| Force Dump . . . . .                    | 55 |
| Copy Dump . . . . .                     | 56 |
| Preserve Dump Dialog . . . . .          | 56 |

---

## 7 Running your Library 59

|  |    |
|--|----|
| Turning on the Library . . . . .             | 59 |
| Turning off the Library . . . . .            | 59 |
| Moving Tape Cartridges . . . . .             | 60 |
| Moving the Picker . . . . .                  | 61 |
| Taking Inventory . . . . .                   | 61 |
| Adding/Removing Tape Cartridges . . . . .    | 62 |
| Importing Tape Cartridges . . . . .          | 63 |
| Manually Inserting Tape Cartridges . . . . . | 63 |
| Exporting a Tape Cartridge . . . . .         | 63 |
| Manually Removing Tape Cartridges . . . . .  | 64 |
| Working with Cleaning Cartridges . . . . .   | 64 |
| Viewing Cleaning Cartridge Status . . . . .  | 64 |
| Importing Cleaning Cartridges . . . . .      | 65 |
| Exporting Cleaning Cartridges . . . . .      | 65 |
| Working with Drives . . . . .                | 65 |
| Unloading a Drive . . . . .                  | 66 |

---

## 8 Configuring your Library 67

|  |    |
|--|----|
| Using AIT WORM Technology . . . . .                | 67 |
| Configuring General Characteristics . . . . .      | 67 |
| Configuring Library Characteristics . . . . .      | 67 |
| Configuring Additional Library Options . . . . .   | 69 |
| Reading Barcodes of Media in Tape Drives . . . . . | 70 |
| Configuring Barcode Length . . . . .               | 70 |
| Setting Drive SCSI IDs . . . . .                   | 71 |
| Setting Drive Loop IDs . . . . .                   | 72 |
| Setting the Date and Time . . . . .                | 72 |
| Password Protecting the Operator Panel . . . . .   | 73 |
| Locking/Unlocking the Mailbox . . . . .            | 73 |

---

## 9 Maintaining your Library 75

|  |    |
|--|----|
| Displaying SACs (Advanced vs Normal Service) . . . . . | 75 |
| Updating Firmware . . . . .                            | 75 |
| Preferred Methods . . . . .                            | 75 |
| Updating Library Firmware . . . . .                    | 75 |
| Updating Drive Firmware . . . . .                      | 76 |

|  |    |
|--|----|
| Creating or Erasing a FUP Tape . . . . .           | 76 |
| Exercising the Picker Fingers . . . . .            | 77 |
| Getting and Putting Tape Cartridges . . . . .      | 77 |
| Opening/Closing and Extending/Retracting . . . . . | 78 |
| Exercising the Barcode Scanner . . . . .           | 79 |
| Exercising the Picker Axes . . . . .               | 79 |
| Moving the Picker in a Motion Pattern . . . . .    | 79 |
| Moving the Picker in Increments . . . . .          | 80 |
| Sending the Picker to the Home Position . . . . .  | 80 |
| Exercising the Library . . . . .                   | 80 |
| Running a Demo . . . . .                           | 80 |
| Running a Self Test . . . . .                      | 81 |
| Teaching the Library . . . . .                     | 81 |
| Resetting a Drive . . . . .                        | 82 |
| Servicing Drives . . . . .                         | 82 |
| Preparing a Drive . . . . .                        | 82 |
| Running Drive Diagnostic Tests . . . . .           | 83 |

---

## 10 Working with Tapes and Barcodes 85

|  |    |
|--|----|
| Selecting Approved Media Types . . . . .   | 85 |
| Write-Protecting Tape Cartridges . . . . . | 85 |
| Tape Use Guidelines . . . . .              | 85 |
| Using Barcode Labels . . . . .             | 86 |
| Applying Barcode Labels . . . . .          | 86 |
| Barcode Label Requirements . . . . .       | 86 |

---

## 11 Using the Remote Management Unit 89

|   |    |
|---|----|
| Supported Browsers . . . . .                      | 90 |
| RMU Requirements . . . . .                        | 90 |
| Setting up the RMU . . . . .                      | 90 |
| Starting the RMU . . . . .                        | 91 |
| Logging into the RMU . . . . .                    | 91 |
| Checking Status and General Information . . . . . | 91 |
| Configuring Network Parameters . . . . .          | 92 |
| Configuring SNMP . . . . .                        | 92 |
| Downloading the SNMP MIB File . . . . .           | 92 |
| Configuring RMU User Accounts . . . . .           | 92 |
| Adding/Removing Users . . . . .                   | 93 |
| Changing a Password . . . . .                     | 93 |
| Configuring the Time and Date . . . . .           | 93 |
| Updating Firmware . . . . .                       | 94 |
| Viewing Diagnostic Files . . . . .                | 94 |
| Using the Operator Panel (via the RMU) . . . . .  | 95 |
| Viewing Logs . . . . .                            | 95 |
| Getting Help . . . . .                            | 95 |
| Replacing the RMU . . . . .                       | 95 |

---

## 12 Troubleshooting and Help 97

|  |     |
|--|-----|
| Service Action Codes . . . . .           | 97  |
| Operator Intervention Messages . . . . . | 105 |
| Operator Information Messages . . . . .  | 109 |
| Interpreting Drive LEDs . . . . .        | 110 |

---

## 13 Specifications 111

|  |     |
|--|-----|
| Power . . . . .  | 111 |
| Tape Cartridge Capacity . . . . .                      | 112 |
| Drive Capacity . . . . .                               | 112 |
| Allowed Tape Cartridges and Storage Capacity . . . . . | 112 |
| AIT . . . . .  | 113 |
| SDLT/DLT . . . . .                                     | 114 |
| LTO . . . . .  | 115 |





## About This Guide and Your Product

---

This guide contains information and instructions necessary for the normal operation and management of the Scalar<sup>®</sup> 100. This guide is intended for anyone interested in learning about or anyone that needs to know how to install, configure, and operate the Scalar 100.



### Note

Be sure to read all operating instructions in this manual and in the *System, Safety, and Regulatory Information Guide* before operating this product.

This guide contains information and instructions necessary for the normal operation and management of the Scalar 100 library. This guide is intended for system administrators, operators, or anyone interested in learning about or using the Scalar 100.

## Product Safety Statements

---

This product is designed for processing magnetic tape cartridges. Any other application is not considered the intended use. ADIC will not be held liable for damage arising from unauthorized use of the product. The user assumes all risk in this aspect.

This unit is engineered and manufactured to meet all safety and regulatory requirements. Be aware that improper use may result in bodily injury, damage to the equipment, or interference with other equipment.



### WARNING

**BEFORE POWERING ON OR USING THIS EQUIPMENT, READ THE SYSTEM, SAFETY, AND REGULATORY INFORMATION GUIDE. KEEP THE GUIDE FOR FUTURE REFERENCE.**

## Product Model Number

---

The Scalar 100 model number is as follows: SC100

## Explanation of Symbols and Notes

---

The following symbols appear throughout this document to highlight important information.

**WARNING**

**INDICATES A POTENTIALLY HAZARDOUS SITUATION WHICH, IF NOT AVOIDED, COULD RESULT IN DEATH OR BODILY INJURY.**

**CAUTION**

**Indicates a situation that may cause possible damage to equipment, loss of data, or interference with other equipment.**

**Note**

Indicates important information that helps you make better use of your system.

## Other Documents you Might Need

---

The following documents are also available for this product. These documents can be found on the product CD or at [www.adic.com/manuals](http://www.adic.com/manuals):

- AMC Online Help
- AMC User's Guide (6-00064-xx)
- SNC 5101 User's Guide (62-0197-xx)
- SNC 6101 Installation and Maintenance Guide (6-00701-xx)
- SNC 450x User's Guide (6-00998-xx)
- SNC Firmware 4 Reference Manual (6-00706-xx)
- System, Safety, and Regulatory Information Guide (6-00618-xx)

**Note**

Release Notes are also available for this product. The Release Notes describe changes to your system or firmware since the last release, provide compatibility information, and discuss any known issues and workarounds. The Release Notes can be found in the product box or at [www.adic.com/manuals](http://www.adic.com/manuals).

## Getting More Information or Help

---

More information about this product is available on the Customer Service Center website at [www.adic.com/csc](http://www.adic.com/csc). The Customer Service Center contains a collection of information, including answers to frequently asked questions (FAQs). You can also access software, firmware, and drivers through this site.

For further assistance, or if training is desired, contact ADIC:

- |                                     |  |
|-------------------------------------|--|
| In the USA:                         | 800-827-3822   |
| In Europe and Japan:                | 00-800-9999-3822   |
| For additional contact information: | <a href="http://www.adic.com/contact">www.adic.com/contact</a> |
| To open a Service Request:          | <a href="http://www.adic.com/techsup">www.adic.com/techsup</a> |

# 2

## Description

---

The Scalar 100 automates the retrieval, storage, and control of tape cartridges. It is designed for use in a standard office environment, with a fully finished appearance, or as a rackmounted unit.

The library supports many different drive types and, depending on the type of drive, can contain up to eight drives. There is a mailbox on the front door for inserting and removing tapes. In addition, the operator panel on the front of the library allows you to fully control and configure your library.

There are two types of Scalar 100 libraries available: Library Control Path and Drive Control Path. Library Control Path libraries connect the host to the library through a SCSI connection. Drive Control Path libraries connect the host directly to the drive. Refer to [Host Attachment](#) on page 11 for more information on Library Control Path and Drive Control Path libraries.

For specific information about your library, including data capacity and tape cartridge capacity, refer to [Specifications](#) on page 111.

**Figure 1** Scalar 100



# Drive Support and Related Technologies

---

Drive Control Path libraries support the following tape drives:

- AIT type drives (AIT-2 HVD & LVD, AIT-3 LVD)
- DLT type drives (7000 HVD, 8000 HVD & LVD, SDLT-220 HVD & LVD, SDLT-320 LVD, SDLT-600 LVD)
- LTO type drives (LTO-1 HVD & LVD, LTO-2 LVD, LTO-3 LVD & Fibre)



## Note

Library Control Path libraries do not support mixing different drives types. This includes different models of the same drive type. Drive Control Path libraries do not support mixing different drive types within the same partition; however, different generations of LTO drives can exist within the same partition. Refer to [Partitioning Your Library](#) on page 34 for more information.

The drive type affects the tape cartridge and overall storage capacity. For specific information about your library storage capacity and allowed tape cartridges, refer to [Specifications](#) on page 111.

With the correct drive and library firmware running, an AIT-3 library supports the Sony® AIT™ WORM (write-once-read-many) technology, which allows for non-rewritable and non-erasable data to be written. This technology provides extra security for your data by preventing accidental erasure.

## Front Panel Components

---

The following graphic shows the front panel components. The following text describes the components in detail.

**Figure 2** Front Panel Components

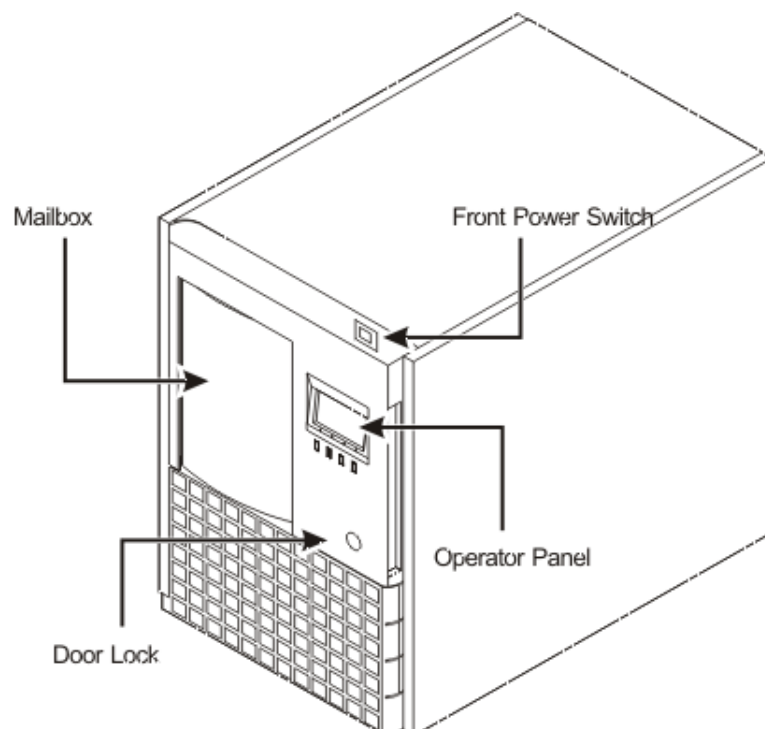

## Front Power Switch

There are two power switches on the library: the front power switch and the rear power switch.

Turning off the front power switch removes power from the internal electronics and removes power from the drives, but the library still contains standby power. The standby power can only be turned off by the rear power switch. Refer to [Rear Power Switch](#) on page 7.



### WARNING

**TO COMPLETELY REMOVE ALL POWER, EITHER USE THE REAR POWER SWITCH OR DISCONNECT THE POWER CORD FROM THE ELECTRICAL SOURCE.**

## Door Lock

The Scalar 100 door lock protects your data from the risk of tampering and prevents unauthorized personnel from entering the mechanical area of the Scalar 100 where serious injury could occur.

When locked, the library door can only be opened from the outside with a key. Authorized personnel are responsible for the security of the key. When shipped, the front door is locked. The key is attached to the back panel of the library.



### WARNING

**THE MECHANICAL COMPONENTS OF THE LIBRARY CAN CAUSE SERIOUS INJURY. ACCESS TO THE LIBRARY SHOULD BE RESTRICTED TO AUTHORIZED PERSONNEL ONLY.**

## Mailbox

The mailbox allows you to import and export tape cartridges without interrupting the normal operation of the library; however, it can also be configured as additional storage slots.

There are two models of the mailbox:

- The standard mailbox has a capacity of one or two tape cartridges. (One tape cartridge for DLT/SDLT and LTO libraries and two tape cartridges for AIT libraries.)
- The optional bulk load mailbox enables you to load multiple tape cartridges at one time.
  - AIT bulk load mailboxes holds 16 tape cartridges in two magazines.
  - LTO bulk load mailboxes holds 12 tape cartridges in two magazines.
  - DLT/SDLT bulk load mailbox holds 10 tape cartridges in two magazines.

## Operator Panel

The operator panel is an LCD screen that enables you to monitor, configure, and service your library. For detailed information on the operator panel, refer to [Using the Operator Panel](#) on page 37.

## Back Panel Components

---

The following graphics show the back panel components of Library Control Path and Drive Control Path libraries. Where appropriate, following the graphics, the components are described in detail.

**Figure 3** Back Panel Components of Library Control Path Libraries

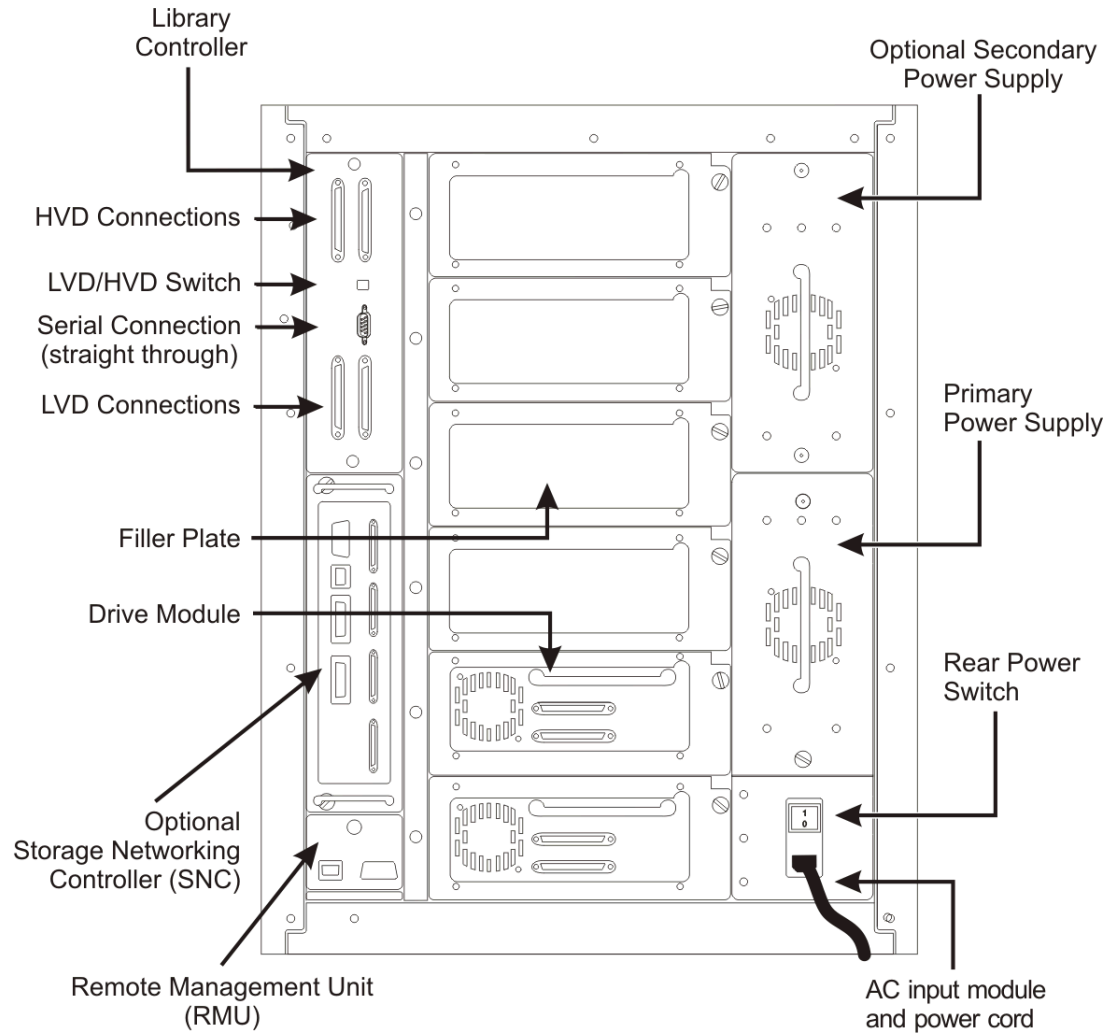

**Figure 4** Back Panel Components of Drive Control Path Libraries

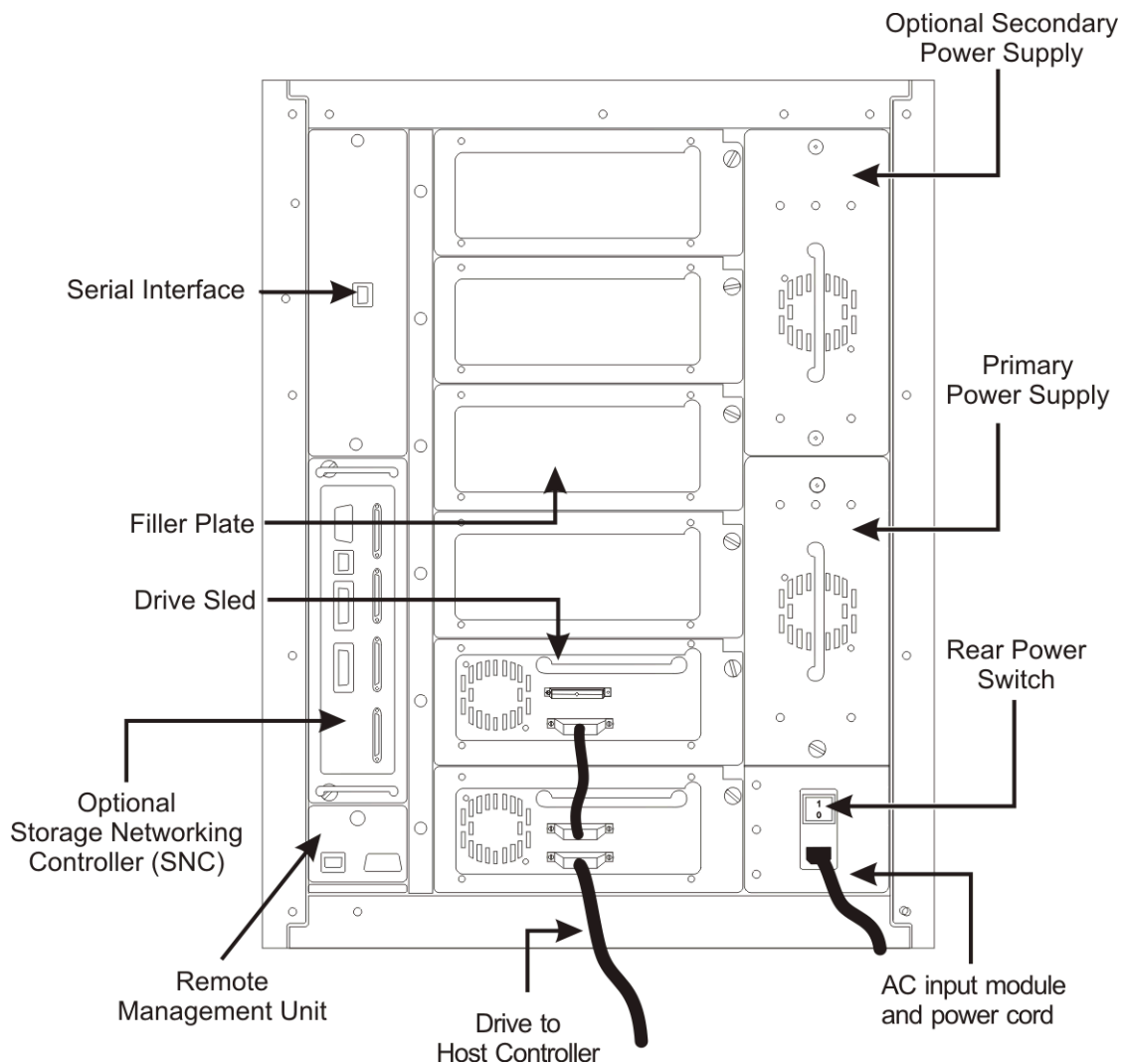

## Library Controller (Library Control Path only)

The library controller is part of Library Control Path libraries. The library controller controls all operations in the library, including the interaction between the library and operators. The library firmware on the library controller creates and maintains the library configuration, the physical location of the robotic system, and the inventory of cartridges. The resulting database is maintained in library controller memory.

The SCSI connections are located on the library controller. A switch on the library controller allows you to switch your library between LVD and HVD connections.

## Rear Power Switch

Turning off the rear power switch removes all power from the library. Turn off the rear power switch whenever you are servicing your library. In the event of danger to personnel or property, immediately turn off the rear power switch.

However, except in emergencies, use the normal shutdown procedure before switching off the rear power switch. ADIC is not responsible for damage caused by improper use of the rear power switch. This risk lies entirely with the user.

## Remote Management Unit

The Remote Management Unit (RMU) allows remote access to the library via a web browser. The RMU resides in each system and is pre-installed at the factory.

The RMU performs the following functions:

- Provides remote operation of all library operator panel functions via a Web browser.
- Allows the user to check the status of the system, firmware levels, and other useful information.
- Updates RMU, drive (LTO only), and library controller firmware.
- Supports Simple Network Management Protocol (SNMP) version 1.0 and acts as an SNMP-server, generating SNMP traps and responding to SNMP requests.
- Supports ADIC Library Management Information Base (MIB) version 2.0.
- Detects a power loss and generates an SNMP trap for notification.
- Enables the retrieval of library logs and library, drive, and RMU diagnostic files.
- Allows RMU configuration changes such as network, users, and date/time changes.

For information on using the RMU, refer to [Using the Remote Management Unit](#) on page 89.

## Storage Networking Controllers (SNCs)

The Scalar 100 offers optional Storage Networking Controllers (SNC) that provide many features for Scalar 100 libraries. For example, they increase data transfer rates, enable you to use and manage your library in a Storage Area Network (SAN) and provide Fibre to SCSI or Gigabit Ethernet to SCSI connectivity.

The available feature set depends on which SNC you integrate into your library. The Scalar 100 supports the SNC 5101, SNC 6101, and the SNC 4500. To learn more about the available SNCs, visit [www.adic.com](http://www.adic.com) or reference the applicable manual(s) on the Scalar 100 product CD.

## Drive Modules and Filler Plates

A drive module is the component that holds the drive and the Fibre or SCSI connections between the drive and the library. Filler plates cover empty drive slots to prevent debris from entering the library.

If you do not have a drive filler plate, contact ATAC before removing a drive.

## Internal Components

---

The robotic system and magazines are the key internal components of the Scalar 100.

### Robotic System and Barcode Scanner

The robotic system identifies and moves cartridges between the storage slots, tape drives, and the mailbox. The robotic arm (picker) has picker fingers that enable it to grab media cartridges and move them into position along X, Y, and Z motion coordinates.

Each tape cartridge contains a barcode that is read by the barcode scanner during the inventory process. The barcode scanner is also used during the teaching process where it reads the fiducial labels to identify the types of storage and tape drives installed in the library.



Every tape cartridge must have a machine and unique operator-readable barcode label attached to it. Tape cartridges cannot have duplicate barcode labels. This barcode identifies the volume serial number (volser). The library stores the physical location of the tape cartridge in an inventory database based on the volser. All library or host requests reference the location of tape cartridges based off of this barcode number.

## Tape Magazines

Tape cartridges are stored in removable magazines in the library. You cannot insert cartridges improperly. The magazines only accept tape cartridges placed in the correct orientation. Once inserted, the tape cartridges will be retained in the magazine even when the magazine is inverted and shaken lightly.

Each magazine has a fiducial barcode label at the bottom of the magazine. This label is read by the barcode scanner during a teach process.

## Slot Numbering

Every slot in the library has a distinct number that identifies it. The format is: column/magazine/slot.

The values are assigned as follows:

- The columns are numbered **1** to **5** clockwise from the mailbox column.
- The magazines within each column are designated **A** to **C** from top to bottom.
- The slots are numbered as follows:
  - The slots within each magazine are numbered **1** to **N** from top to bottom (where N is the number of tape cartridges allowed for that media type).
  - The fixed slots in columns 2, 4, and 5 that do not have a magazine designation are always numbered **0**. For example, the coordinate for the fixed slot in column 2 would be "2 - 0".



Note

For reference, the location for the picker is identified as [0 @ 0] on the operator panel.

**Figure 5** Storage Slot Numbering

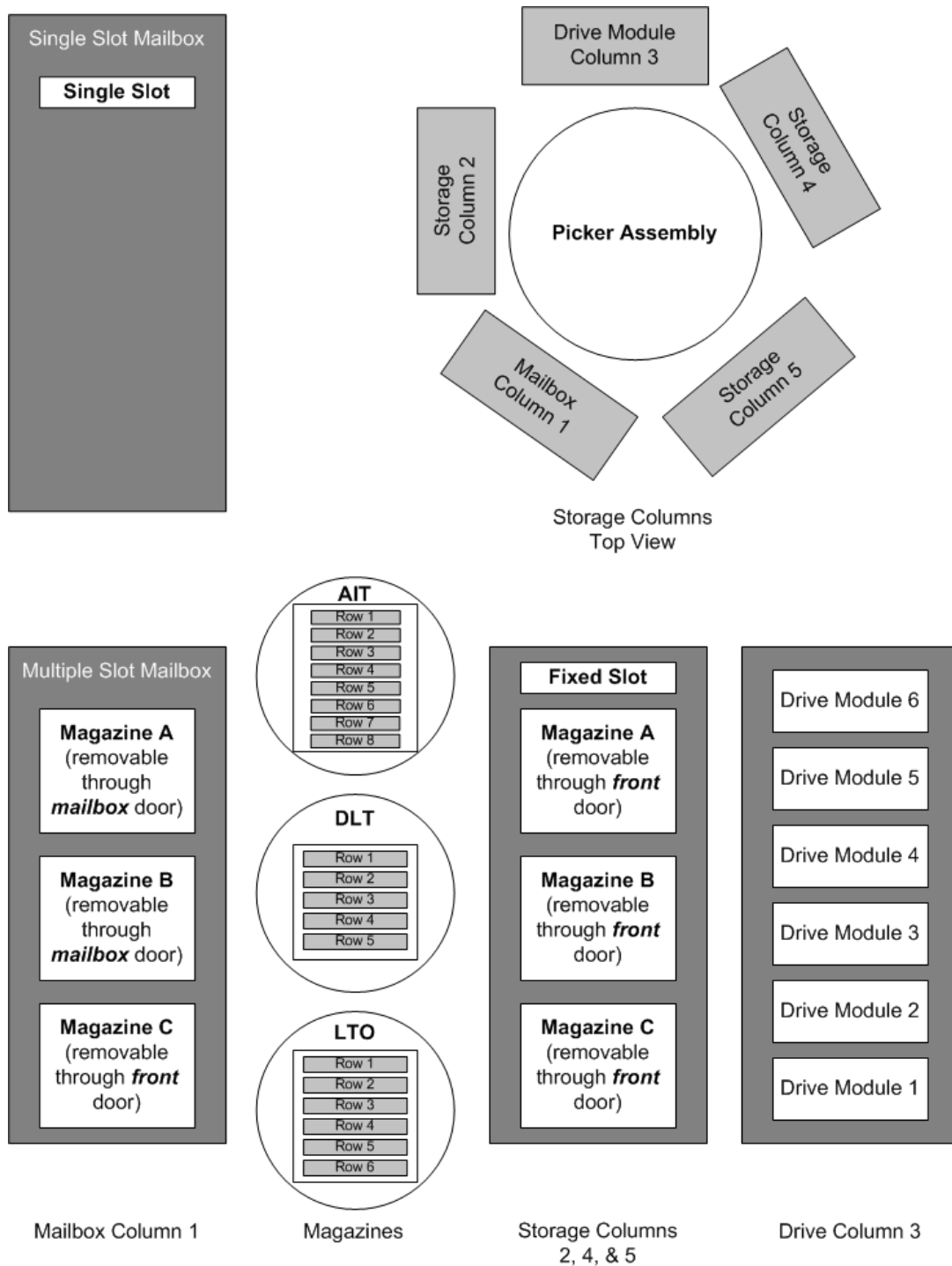

## Drive Module Numbering

The drive modules are numbered **1** to **N** from bottom to top, where N is the number of drives allowed for that media type.

# Host Attachment

---

The Scalar 100 is a SCSI target device supporting communication with a host through fibre or SCSI connections.

## Native Fibre Connections

A library supporting native fibre attachments communicates with a host through an intermediary LUN-1 (Logical Unit Number) interface in one or more installed drives. In this type of connection, a host is connected directly to a drive rather than a library. Communication is accomplished as a host sends commands to and receives status or responses from one or more LUN-1 enabled drives.

LTO-3 drive modules support native fibre connections. Each drive has a single LC fibre connector located in back of the module for attachments.

## SCSI Connections

A library supporting SCSI connections can be connected to LTO-1 or LTO-2 drive modules via a SCSI-2 Low Voltage Differential or High Voltage Differential (LTO-1 only) SCSI bus. Both ends of the bus must be terminated. A terminator is shipped with each library. The SCSI LTO-3 drive module is LVD only. The design of the library allows the SCSI type (LVD or HVD) to be configured at the customer site with a switch located on the Library Controller.

Each LTO drive module has two HD-68 connectors for attachments. (When attaching to a 1-byte host, a 1-byte to 2-byte interposer is required.) Although the library can be attached to a wide SCSI bus, it is not a wide SCSI device and its SCSI ID must be in the range of 0 to 7. The default SCSI ID for the library is 0.

Libraries that do not have native fibre connection capabilities can be connected to a Storage Area Network (SAN) via an optional Storage Networking Controller (SNC), where the SNC converts either Fibre Channel protocol or Gigabit Ethernet (GbE) protocol to parallel SCSI protocol.



# 3

## Setting up your Scalar 100

---

Setting up your library includes actions such as unpacking, connecting power cords and SCSI or Fibre cables, setting SCSI IDs or Loop IDs, and preparing the host computer. The actions discussed here are those you would need the first time you set up your library and if your library is ever moved or reconfigured.

Information on turning on and off the library, is located in [Running your Library](#) on page 59, as it is part of everyday tasks.

### Quick Start Guide

---

For simple setup instructions, refer to the Quick Start Guide available on the *Scalar 100 Documentation and Software CD* or as a printed document in your product box. For more detailed instructions, refer to the [Getting Started Road Map](#) on page 13.

To view the Quick Start Guide, you need to have Adobe® Acrobat® Reader® installed. Go to [www.adobe.com/acrobat/](http://www.adobe.com/acrobat/) to download a free copy.

### Getting Started Road Map

---

To set up your Scalar 100 for the first time, complete all the basic steps listed here.

- 1 Find a location for your library.  
Refer to [Finding a Location](#) on page 14.
- 2 Unpack your library.  
Refer to [Unpacking your Library](#) on page 14.
- 3 Install any optional or additional hardware that you ordered for your library.  
Refer to [Using the Optional Features](#) on page 23.
- 4 Connect the power cords and SCSI or Fibre cables.  
Refer to [Cabling Library Control Path Libraries](#) on page 15 or [Cabling Drive Control Path Libraries](#) on page 16.
- 5 Turn on the library.  
Refer to [Turning on the Library](#) on page 59.
- 6 If necessary, set the SCSI IDs or Loop IDs for the library and drives so that they are unique from any other device on the SCSI bus or Fibre attachments.

Refer to [Configuring your Library](#) on page 67.

7 Prepare the host system.

Refer to [Cabling Drive Control Path Libraries](#) on page 16.

8 Verify communication between the library and the host.

Refer to [Verifying Communication with the Host](#) on page 22.

## Finding a Location

---

When positioning the library, consider the following:

- The location must provide adequate front and rear ventilation (at least two inches, the space provided by the cabling will suffice).
- Situate the product away from heat sources such as radiators, heat registers, furnaces, or other heat-producing appliances.
- Ensure a power source (only of the type directed in the operating instructions or as marked on the product label) is available.
- Route the AC line cord so that it is not likely to be walked on or pinched by items placed upon or against it, paying particular attention to the cord at the wall receptacle, and the point where the cord exits from the product.
- Ensure that objects will not fall and liquids are not spilled into the product's enclosure through openings.
- Do not position in an area that will expose the unit to moisture or high temperatures or extreme low temperatures.
- Keep the unit away from direct strong magnetic fields, excessive dust, and electronic/electrical equipment that generate electrical noise.
- Position the unit on a firm, level surface free from vibration.

## Unpacking your Library

---



**CAUTION**

**If you need to return your library, you must ship it in the original or equivalent packing materials or your warranty may be invalidated.**



**CAUTION**

**Do not move the picker assembly along the rotary axis by hand as it will be damaged. The picker assembly can be rotated by turning the gear on the rotary motor by hand.**

1 Unpack all items from the carton.

Save the packing materials in case you need to move or ship the system in the future.

2 Inspect the items that came with your library and ensure none are damaged.

3 Complete either the written registration card or register the product on the ADIC website at [www.adic.com](http://www.adic.com).

The Scalar 100 serial number is located on the product label on the back of the library and on the inside of the front door.

- 4 Remove the key from the rear panel of the library. Unlock and open the front door.
- 5 Remove the interior packaging or securing material from the library to allow picker movement. (Make sure to remove the rubber band from around the picker.)
- 6 Install tape cartridges into magazines.

## Cabling Library Control Path Libraries

Part of the setup process for Library Control Path libraries is connecting the power and SCSI cables. When setting up your library, ensure that the last device on the SCSI bus is properly terminated. An appropriate terminator is shipped with each library. For specific SCSI connection information, refer to [Host Attachment](#) on page 11.

 **Note** The default SCSI ID is 0 for the library controller, this default value will appear when a new main controller PCBA is installed or after a firmware update.

- 1 Connect the power cord to the power outlet on the rear of the library.
- 2 On the bottom most drive, connect a jumper cable to the top SCSI connector and then to the bottom SCSI connector on the drive above it. Repeat this for all drives in the SCSI bus.

If you have more than two drives, split the drives between SCSI buses so that there are no more than two drives per SCSI bus. Refer to the following steps.

 **Note** AIT libraries cannot have tape drives installed in the bottom-most or top-most drive module slots.

- 3 Terminate the last device(s) on the SCSI bus(es) with an appropriate terminator (LVD or HVD). Refer to [Figure 6](#).

**Figure 6** SCSI Bus Terminator

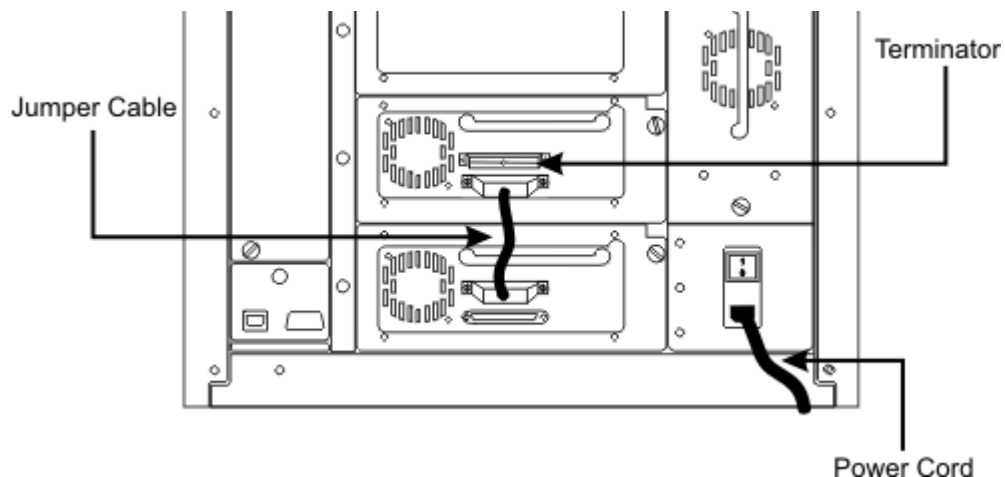

- 4 Install the cables between the bottom drive and the library controller and between the Library Controller and the host. Refer to [Figure 7](#).

If you have more than one SCSI bus, connect a cable between the bottom drive on the SCSI bus to the host.

**Figure 7** SCSI Cabling in a Library Control Path Library

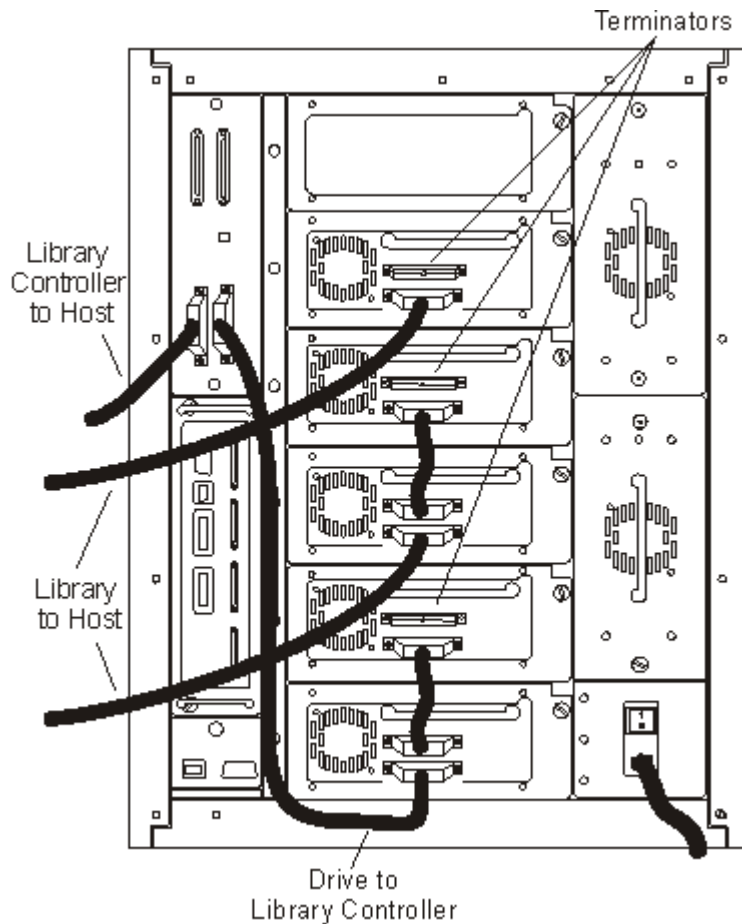

## Cabling Drive Control Path Libraries

There are two ways to cable Drive Control Path libraries: SCSI cables or Fibre cables. For specific SCSI and Fibre connection information, refer to [Host Attachment](#) on page 11.

### Connecting the Power and Fibre Cables in a Drive Control Path Library

- 1 Connect the power cord to the power outlet on the rear of the library.
- 2 Install a Fibre cable between the bottom drive Fibre port and the host. Refer to [Figure 8](#).  
Repeat for each additional drive installed.

 **Note** The Fibre cable can be connected from the drive to a switch rather than a host.



**Figure 8** Fibre Channel Cabling in a Drive Control Path Library

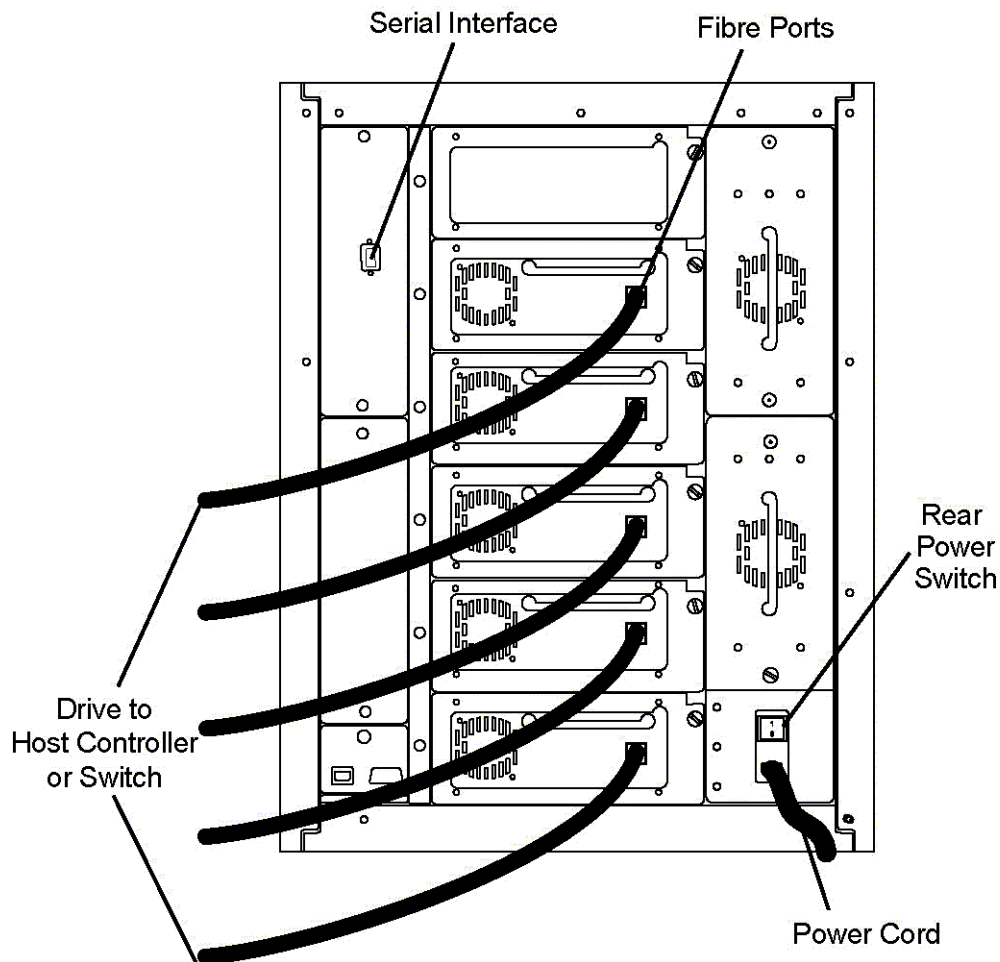

## Connecting the Power and SCSI Cables in a Drive Control Path Library

- 1 Connect the power cord to the power outlet on the rear of the library.
- 2 On the bottom-most drive, connect a jumper cable to the top SCSI connector on the drive above it. Repeat this for all of the drives.  
If you have more than two drive, split the drive between SCSI buses.
- 3 Terminate the SCSI buses with an appropriate terminator (LVD or HVD).
- 4 If you have more than one SCSI bus, connect a SCSI cable between the bottom drive and the host. Refer to [Figure 9](#) on page 18.

**Figure 9** SCSI Cabling in a Drive Control Path Library

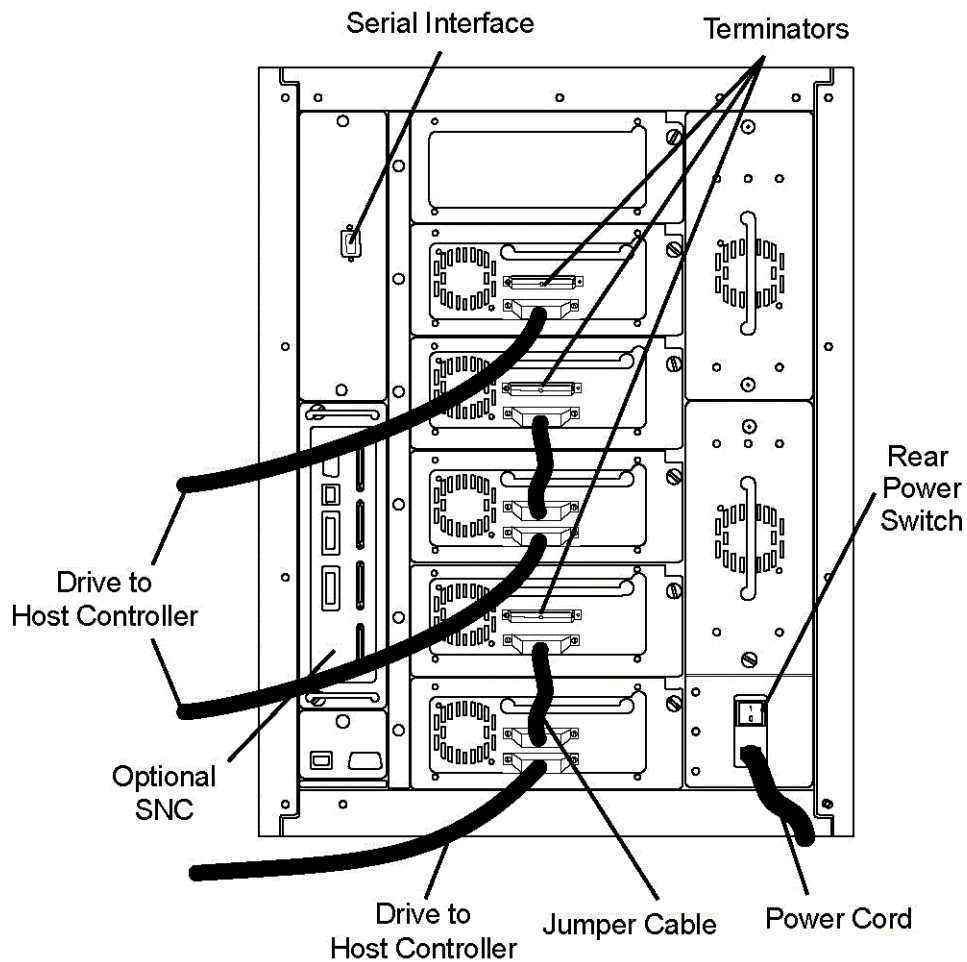

## Preparing the Host

If necessary, install a SCSI host system adapter, software, and compatible driver(s). Refer to the manuals for the host system and SCSI host system adapter for detailed instructions. In addition, follow these general guidelines:

- When the host server system is turned on, install the software, and/or driver(s) that are compatible with the library.
- If the host server system is connected to a network, check with the system administrator before turning off the power to the host.
- Prevent electrostatic discharge (ESD) by following proper procedures. Always use wrist-grounding straps and anti-static mats when handling internal components.
- Make certain the host server system has an open expansion slot.

# Host Coordinate System

To manipulate the media within the library, the host must reference each movement with source and target designations. This is done via element addressing, which specifies precisely which slots within the library are to be used. The following addressing scheme is used for the library. These values may need to be entered into your host application.

**Table 1** Element Addressing

| Slot Type | Starting Address |
|-----------|------------------|
| Storage   | 4096 : (0x1000)  |
| Mailbox   | 16 : (0x0010)    |
| Drives    | 256: (0x0100)    |
| Picker    | 1: (0x0001)      |

## Installing a SCSI Adapter

For SCSI libraries to communicate, your host computer must have a SCSI adapter. If your host computer does not have SCSI capability, you will need to install a SCSI adapter. For installation instructions, refer to the manual that comes with the adapter.

## Installing Drivers

When using Removable Storage Manager (RSM), ensure that the proper drivers for the library and drives are installed.

Go to [www.adic.com/locatedrivers](http://www.adic.com/locatedrivers) for the latest device drivers and ISV device upgrades.

## Installing Drivers for Microsoft Windows 2000 and Windows Server 2003 Systems

When using Microsoft® Windows® 2000 and Windows Server 2003, you must install drivers for both the library and the tape drives.



### Note

In Windows Server 2003, the library and/or tape drive drivers may come pre-installed. If so, it will be automatically loaded for the appropriate devices.

Follow the steps below to install the Windows 2000 or Windows Server 2003 library driver:

- 1 Ensure the library is powered on and fully booted.
- 2 Connect the library to the host and then restart the host.
- 3 Obtain the appropriate driver. You may need to consult your service representative.
- 4 Start Device Manager.
- 5 In Device Manager, expand the **Medium Changers** node.
- 6 Right-click **Unknown Medium Changer Device** and select **Properties**.
- 7 On the **Driver** tab, select **Update Driver**.

This will start the Upgrade Device Driver Wizard.

- 8 Click **Next**.
- 9 Select **Search for a suitable driver for my device**. Select **Next**.

- 10 In **Optional search locations** select the checkbox for the appropriate location and then select **Next**.
- 11 Setup will select the installation file, SC100.inf. Select **Next**.  
The required files are installed.
- 12 Select **Finish** and then close out of the Upgrade Device Driver Wizard.
- 13 In the Windows Device Manager, under **Medium Changers**, ensure that the appropriate device is listed.

Follow the steps below to install the Windows 2000 or Windows Server 2003 drive driver:

- 1 Ensure that the library is powered on and is fully booted.
- 2 Connect the library to the host and then restart the host.
- 3 Start **Device Manager**.
- 4 In the **Device Manager** window, locate the appropriate device for your library drive type:
  - AIT-2: **SONY SDX-500C Sequential Device**
  - AIT-3: **SONY SDX-700C Sequential Device**
  - LTO-1: **IBM ULTRIUM-TD1 SCSI Sequential Device**
  - LTO-2: **IBM ULTRIUM-TD2 SCSI Sequential Device**
  - LTO-3: **IBM ULTRIUM-TD3 SCSI Sequential Device**
  - SDLT-220: **Quantum SDLT1 SCSI Sequential Device**
  - SDLT-320: **Quantum SDLT320 SCSI Sequential Device**
  - SDLT-600: **Quantum SDLT600 SCSI Sequential Device**
- 5 Right-click on the appropriate device and select **Properties**.
- 6 On the **Driver** tab, select **Update Driver**.  
This will start the Upgrade Device Driver Wizard.
- 7 Click **Next**.
- 8 Select **Search for a suitable driver for my device**. Select **Next**.
- 9 In **Optional search locations** select the check box for the appropriate location and then select **Next**.
- 10 Setup will select the installation file, magtape.inf (LTO-1), dtpageW2k.inf / dtape2k3.inf .inf (LTO-2), or qntmsdlt.inf (SDLT). Click **Next**.  
The required files are installed.
- 11 Select **Finish** and then close out of the Upgrade Device Driver Wizard.

**12** In the **Device Manager** window, ensure that the appropriate device is listed under **Tape Devices** entry. The listings differ, depending on your library type:

- AIT-2: **SONY SDX-500C Sequential Device**
- AIT-3: **SONY SDX-700C Sequential Device**
- LTO-1: **IBM ULTRIUM-TD1 SCSI Sequential Device**
- LTO-2: **IBM ULTRIUM-TD2 SCSI Sequential Device**
- LTO-3: **IBM ULTRIUM-TD3 SCSI Sequential Device**
- SDLT-220: **Quantum SDLT1 SCSI Sequential Device**
- SDLT-320: **Quantum SDLT320 SCSI Sequential Device**
- SDLT-600: **Quantum SDLT600 SCSI Sequential Device**

## Installing Drivers for Microsoft Windows NT 4.0 Systems

When using Microsoft® Windows NT® 4.0, you only need to install the tape drive device driver. There are no medium changer drivers necessary for Windows NT 4.0.



### Note

There are no tape drive device drivers available for LTO-2 libraries in an Windows NT 4.0 environment.

Follow the steps below to install the Windows NT 4.0 driver:

- 1** Ensure the library is powered on and fully booted.
- 2** Connect the library to the host and then restart the host.
- 3** Obtain the appropriate drivers. You may need to consult your service representative.
- 4** In the Control Panel, double-click the **Tape Devices** icon.



### Note

If the host server or workstation already has drivers installed, continue with the next step, otherwise, skip the next two steps.

- 5** Select the **Drivers** tab and then select **Add**.
- 6** Select **Have Disk**.
- 7** Type **x:\drivers \nt4**, replacing x with the path to the drivers you obtained in [Step 3](#).
- 8** Select the appropriate drive type:
  - AIT-2: **SONY AIT Tape Drive (NT 4.0)**
  - AIT-3: **SONY AIT Tape Drive (NT 4.0)**
  - LTO-1: **IBM Ultrium Tape Drives (OEM)**
  - LTO-2: Not Supported
  - SDLT-220: **QUANTUM DLT/SuperDLT Driver for NT4 - Ver 2.0**
  - SDLT-320: **QUANTUM DLT/SuperDLT Driver for NT4 - Ver 2.0**
- 9** Select **OK**.
- 10** When the **New SCSI Tape Device Found** dialog box appears, click **OK**.
- 11** If prompted, type the path to the drivers once again and click **Continue**.  
Required files will now be installed for the driver.

- 12 If you have multiple drives of this type, click **OK** at each prompt to install the driver for each device.
- 13 When the driver has been installed for all devices, in the **Tape Devices** dialog box, select **OK**.
- 14 Restart the host server or workstation.
- 15 After restarting, in the control panel, double-click the **Tape Devices** icon and verify that the drivers were properly loaded by locating them in the Windows Device Manager.

## Verifying Communication with the Host

---

Read the following to learn how to verify communication between the library and the host. For more information on verifying the connection of SCSI devices, consult the operating system documentation.

- Verify the connection between the library and host system by making sure that the operating system of the host server recognizes the library. In Microsoft® Windows®, this is done as follows:
  - In Windows NT®: **Settings > Control Panel > SCSI Devices**
  - In Windows 2000: **Settings > Control Panel > System > Hardware > Device Manager > Tape Drive or Medium Changers**

# 4

## Using the Optional Features

---

Optional features are available to configure your library to meet your specific needs. The optional features available to you include:

- Rackmounting hardware (rackmount kit)
- Side panels (floor model kit)
- Casters (floor models only)
- Additional drives
- Secondary power supply
- Bulk load mailbox
- Additional storage columns
  - Each column can hold up to three magazines.
- Storage Networking Controllers (SNC)
  - Library Control Path libraries support SNC 5101 and SNC 6101. Drive Control Path libraries support SNC 6101.
  - For information on the available SNC components, refer to the applicable manual on the Scalar 100 product CD or at [www.adic.com](http://www.adic.com).
- Partitioning
- AutoClean

### Rackmounting Your Library

---

If you are rackmounting your library, use the rackmounting kit that is available from ADIC. The Scalar 100 requires 14U space in a standard 19 inch rack.

Before rackmounting your library, read the following guidelines:

- For continued safe operation, the recommended maximum internal ambient temperature of the rack should not exceed 40°C.
- During installation of a rackmounted unit, do not block or otherwise restrict airflow to the power supply front or rear vents.
- To maintain rack stability, make certain mechanical loading of the rack results in a low center of gravity.

- Before installing a unit into a rack, consider the overall loading of the branch circuit supplying power to the rack. Refer to [Specifications](#) on page 111 for the library power requirements.
- Because this unit is intended to be attached to an earth ground, ensure that a reliable path to earth ground is maintained within the rack.

Tools required:

- Phillips screwdriver, 3/8 nut driver
- T20 Torx driver

- 1 Ensure space is available in the rack (14U space in a standard 19 inch rack). Measure and mark the holes to simplify the installation process.
- 2 Install the rear rackmount hardware by attaching the sheet metal to the rear rack. Depending on the type of rack, use either the cage nut or the clip nut.

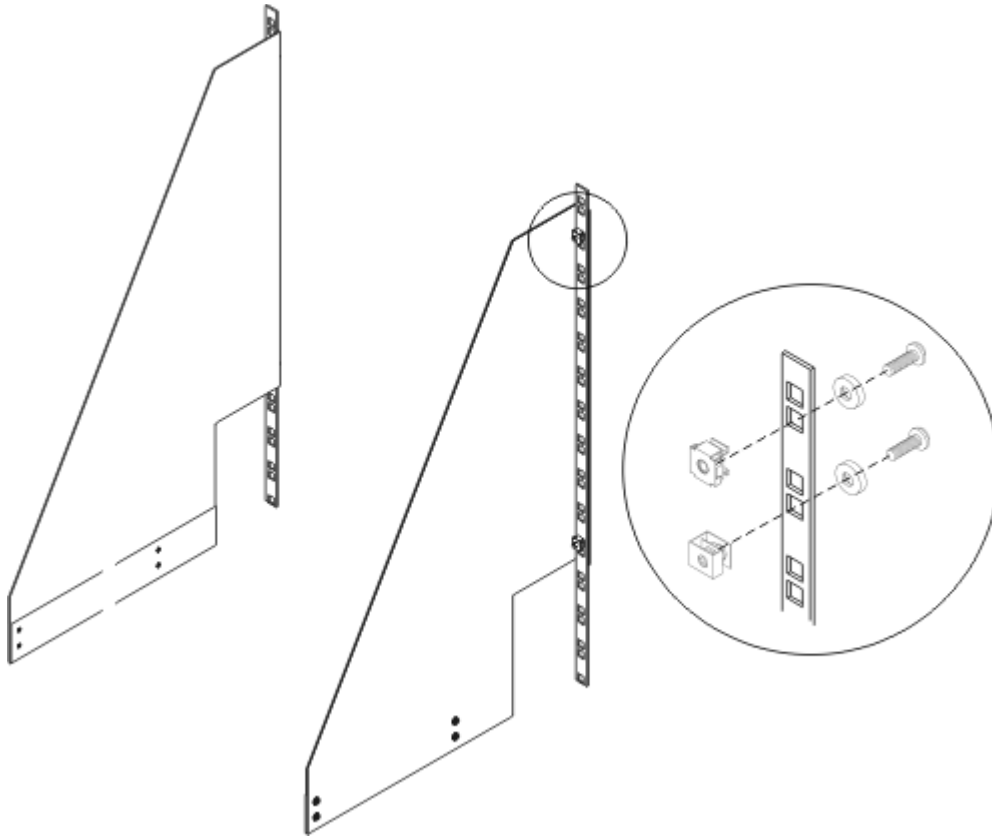



- 3 Install the front rackmount hardware by attaching the sheet metal to the front rack.

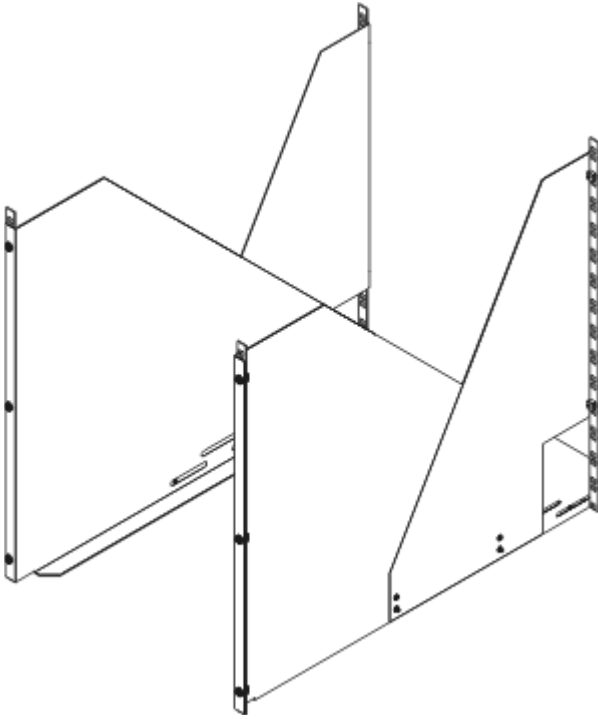

- 4 Secure the front hardware to the rear hardware by installing four screws on each side.
- 5 Complete the rackmount hardware installation by attaching the rear bracket to the rackmount hardware.

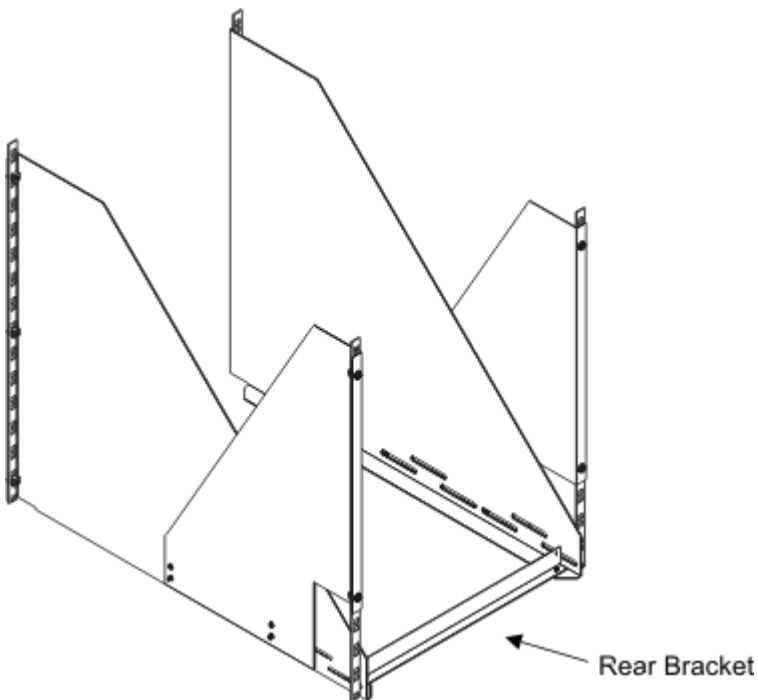

- 6 Remove the four rubber feet or casters from the bottom of the library by removing the securing screws.

- 7 Remove the side covers. Looking at the rear of the library, unscrew the four Phillips screws that secure each of the side covers (eight screws total). After removing the Phillips screws, open the front door and slide the covers off the library.
- 8 Remove all drives and the DC power supplies from the library to reduce its weight. Each of these items can be easily removed by loosening the captive thumbscrews and sliding the item out of the chassis.

**WARNING**

**EVEN WITH THE ABOVE COMPONENTS REMOVED, THE SCALAR 100 WEIGHS IN EXCESS OF 150 LBS (65 KGS) AND REQUIRES TWO PERSONS TO PROPERLY LIFT AND POSITION IT IN A RACK.**

- 9 Standing at the front of the rack, use the handles on both sides of the Scalar 100 to lift and position the library onto the rackmount hardware.
- 10 Slide the library into the rack until it stops.

## Installing Side Panels

---

Your library can be setup as a floor model or a rackmount library. Read the following instructions to configure your library as a floor model unit, by installing side panels.

Tools required:

- Large flat blade screwdriver or 3/8 nut driver
- Phillips screwdriver

- 1 Verify that the Scalar 100 library is turned off using the main switch on the rear of the library. Turning off power using only the front panel switch is not sufficient.
- 2 Fully open the front door of the library.
- 3 Install the side panel by capturing the vertical flange on the front of the library. The four holes on the side panel should align with the four holes in the rear of the library.

**Note**

Both side panels are identical and can be installed on either side of the library.

- 4 Using a Phillips screwdriver, install the four thread-cutting screws contained in the Floor Model Kit.
- 5 Repeat steps 1 through 4 to install the other side panel.
- 6 Close the front door of the library.
- 7 If you are installing casters on this library, refer to [Installing Casters](#) on page 27. Otherwise, move the library to its permanent location.

If the Scalar 100 is installed on a raised floor with forced air below, ensure that a floor cutout is beneath the library.

# Installing Casters

---

Castors are an optional feature that are for use only with floor model library configurations.

Tools required:

- Large flat blade screwdriver or 3/8 nut driver
  - Phillips screwdriver
- 1 Place the Scalar 100 on its side for this procedure. Use the sling shipped with the library to tip the library onto its side.
  - 2 Using a Phillips screwdriver, remove the four rubber feet from the bottom of the library.
  - 3 Install the two fixed casters to the back of the library with four bolts.
  - 4 Install the two swivel casters on the front of the library with four bolts. Lock the two front casters in place.

# Installing/Removing Drives

---

Drives modules need to be installed sequentially in the library and within the same partition. An empty drive slot can not be located between two drive modules. If one of the middle drive modules is removed. The other drives must be moved to fill the empty slot.

Follow the procedures below to install or remove a drive.

## Installing a Drive

When installing drives into your library, note that drive types cannot be mixed within the library. LVD and HVD cannot be mixed within the same partition.



### Note

If you have difficulties installing or replacing a drive, try resetting the drive and/or rebooting the library and host. Also, ensure that the new drive uses a unique SCSI ID or Loop ID as appropriate.

Tools required:

- None
- 1 From the rear of the library, find the lowest available drive slot. Loosen the two thumbscrews on the filler plate and remove the filler plate. Store the filler plate in a safe location for future use.  
Note that AIT tape drives cannot be installed in the bottom-most or top-most drive slot.
  - 2 Slide the drive module into position and tighten the two captive thumbscrews.



### Note

If you have more than two drives, when cabling the library, split the drives between SCSI buses so that there are no more than two drives per SCSI bus. Refer to [Cabling Library Control Path Libraries](#) on page 15 for more information.

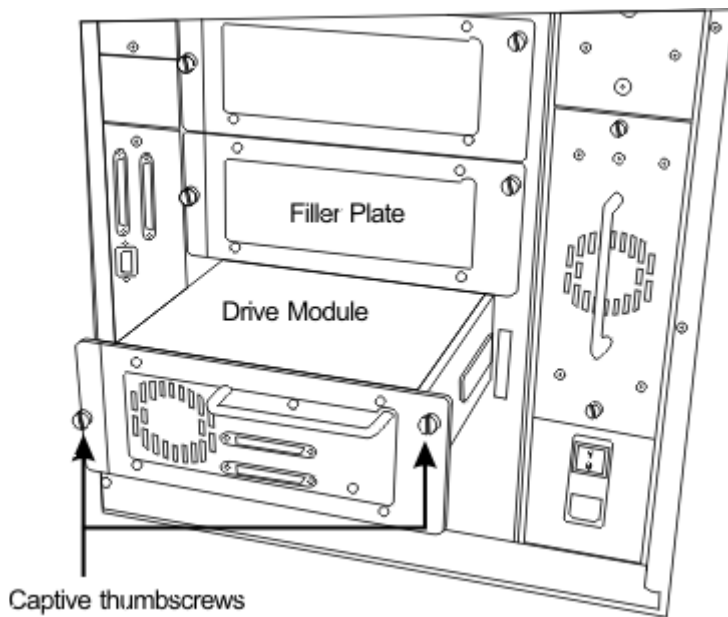

## Removing a Drive

Tools required:

- None

- 1 Take the tape drive offline (in the host software).
- 2 If your library is an LTO-1 HVD, prepare the library using the operator panel: **Main Menu > More > Service > Drives > Repair > Remove**.
- 3 Loosen the two captive thumbscrews from the drive and slide the drive out using its handle.
- 4 Unless you are immediately replacing the drive, install the filler plate (that you removed when you installed the drive) to the drive slot.

 **Note** If you do not already have one, contact ATAC to receive a filler plate.

## Replacing a Drive



### Note

If you have difficulties installing or replacing a drive, try resetting the drive and/or rebooting the library and host. Also, ensure that the new drive uses a unique SCSI ID or Loop ID, as appropriate.

- 1 Remove the existing drive. (Refer to [Removing a Drive](#) on page 28.)
- 2 Install the new drive. (Refer to [Installing a Drive](#) on page 27.)
- 3 If your library is an LTO-1 HVD, notify the library that a drive has been replaced using the operator panel:

**Main Menu > More > Service > Drives > Repair > Replace**



### Note

Note that the drive will remain off the bus until the library has set the SCSI ID or Loop ID of the drive.

## Installing a Secondary Power Supply

---

Use the following instructions to install a secondary power supply.

Tools required:

- none

- 1 On the rear of the library, find the secondary power supply slot. Loosen the two thumbscrews on the cover plate and remove the cover plate.



**WARNING**

**LIVE AC VOLTAGE IS PRESENT ON THE DC POWER SUPPLY CONNECTOR AT THE REAR OF THE COMPARTMENT. EXERCISE EXTREME CARE WHEN WORKING IN OR NEAR THE DC POWER SUPPLY COMPARTMENT.**

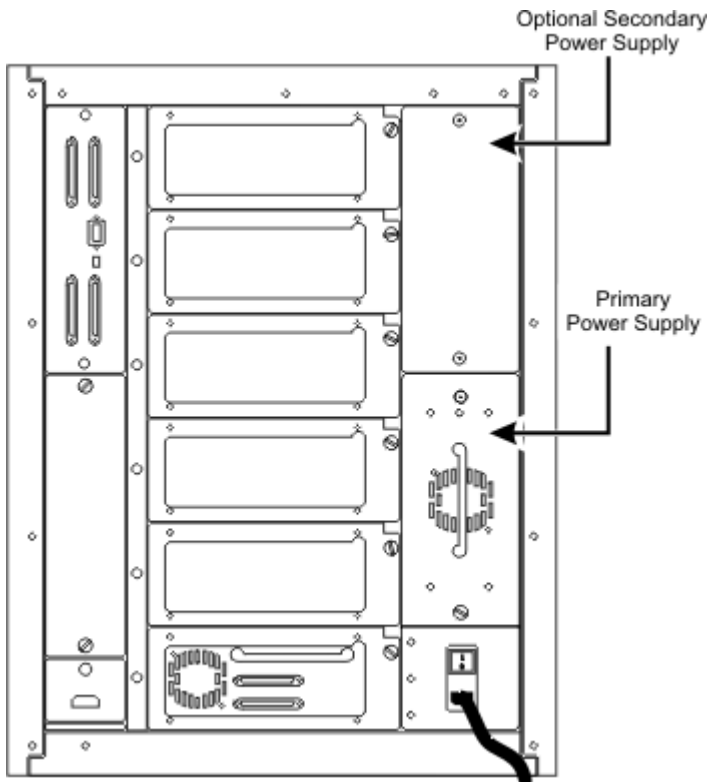

- 2 Slide the power supply into position until it mates with the power distribution PCBA and tighten the two captive thumbscrews.



**Note**

A Service Action Code (SAC) appears without taking the library offline. Refer to [Service Action Codes](#) on page 97.

## Installing Bulk Load Mailbox

---

To install a bulk load mailbox you must first remove the standard mailbox.

Tools required:

- T20 Torx driver
- #2 Phillips screw driver
- #2 and 11/32 nut driver

## Removing the Standard Mailbox

Use [Figure 10](#) to assist you in removing the standard mailbox.

**Figure 10** Removing a Standard Mailbox

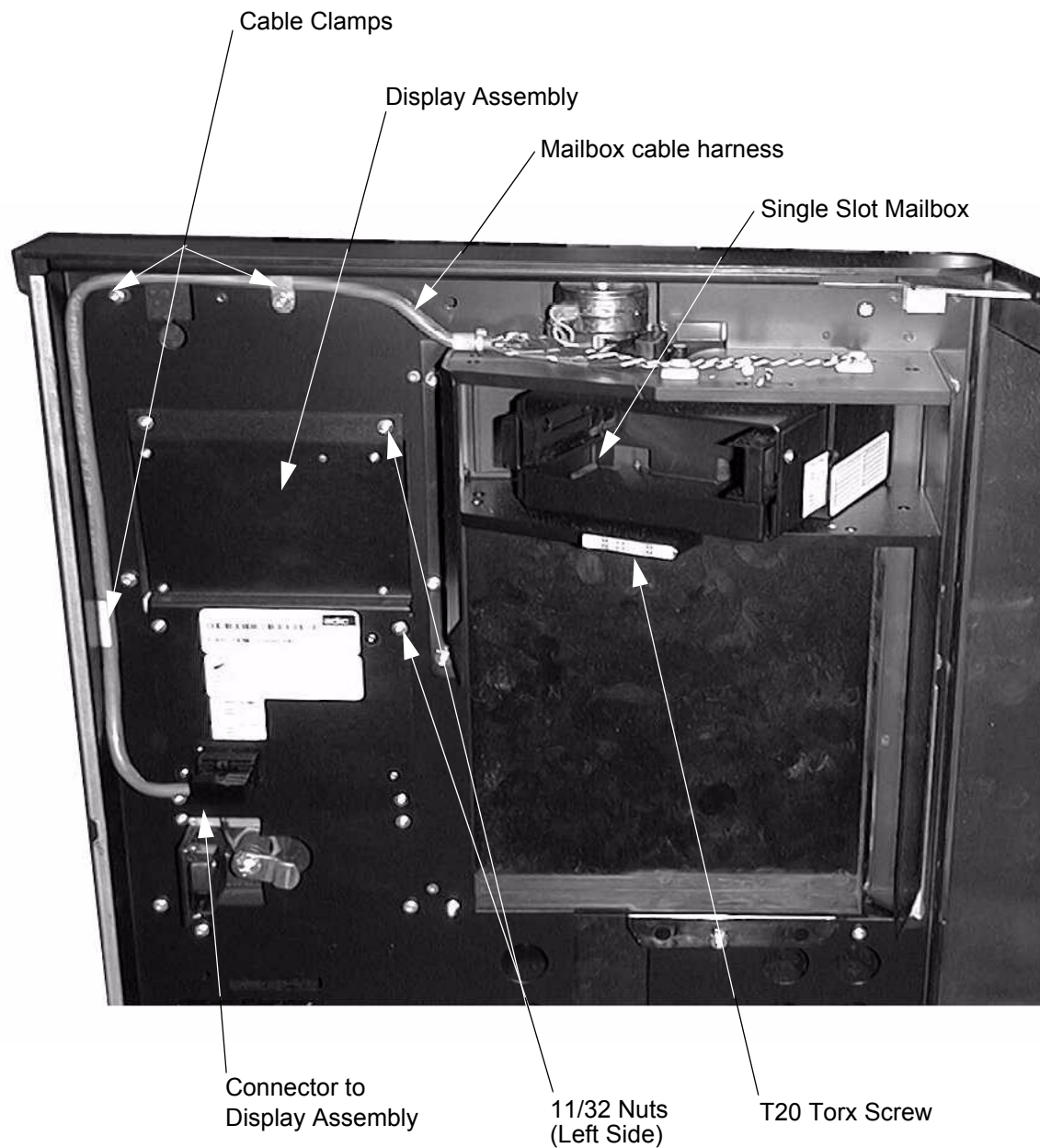

- 1 Turn off the Scalar 100 library. (Both the front and the rear power switches.)
- 2 Open the library front door. Remove the tape cartridge(s) from the standard mailbox.
- 3 Remove the three mailbox cable clamps. Two of the cable clamps are attached to the door with #2 Phillips screws and one is attached with a 11/32 nut. Disconnect the mailbox cable harness from the display assembly.
- 4 Remove the five 11/32 nuts that attach the mailbox assembly to the front door. There are two nuts on the left side and three on the right side.

- 5 Remove the 11/32 nut from the bottom of the plastic cover and loosen T20 torx screw under the mailbox door.
- 6 Remove the standard mailbox assembly.
- 7 Remove the plastic cover by lifting it up and sliding it through the front door.

## Installing the Bulk Load Mailbox

Use [Figure 11](#) when installing the bulk load mailbox.

**Figure 11** Installing a Bulk Load Mailbox

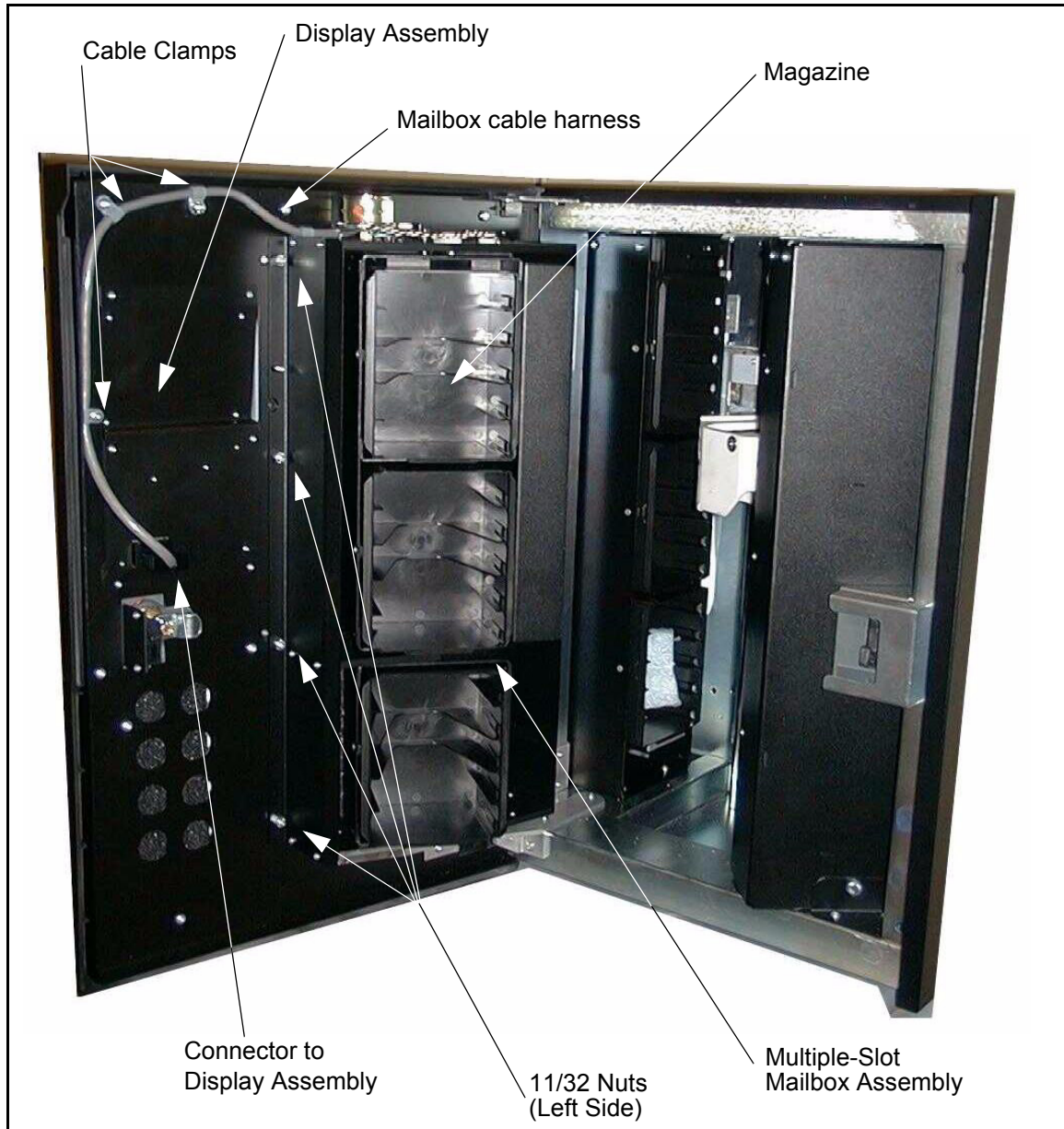

- 1 Attach the bulk load mailbox to the door using eight 11/32 nuts.
- 2 Attach the cable clamps using 2 Phillips screws and one 11/32 nuts. Connect cable to the display assembly.



- 3 Insert magazines and any tape cartridges in the mailbox.

## Installing a Storage Column

Refer [Figure 12](#) to when installing a storage column.

**Figure 12** Installing the Storage Column

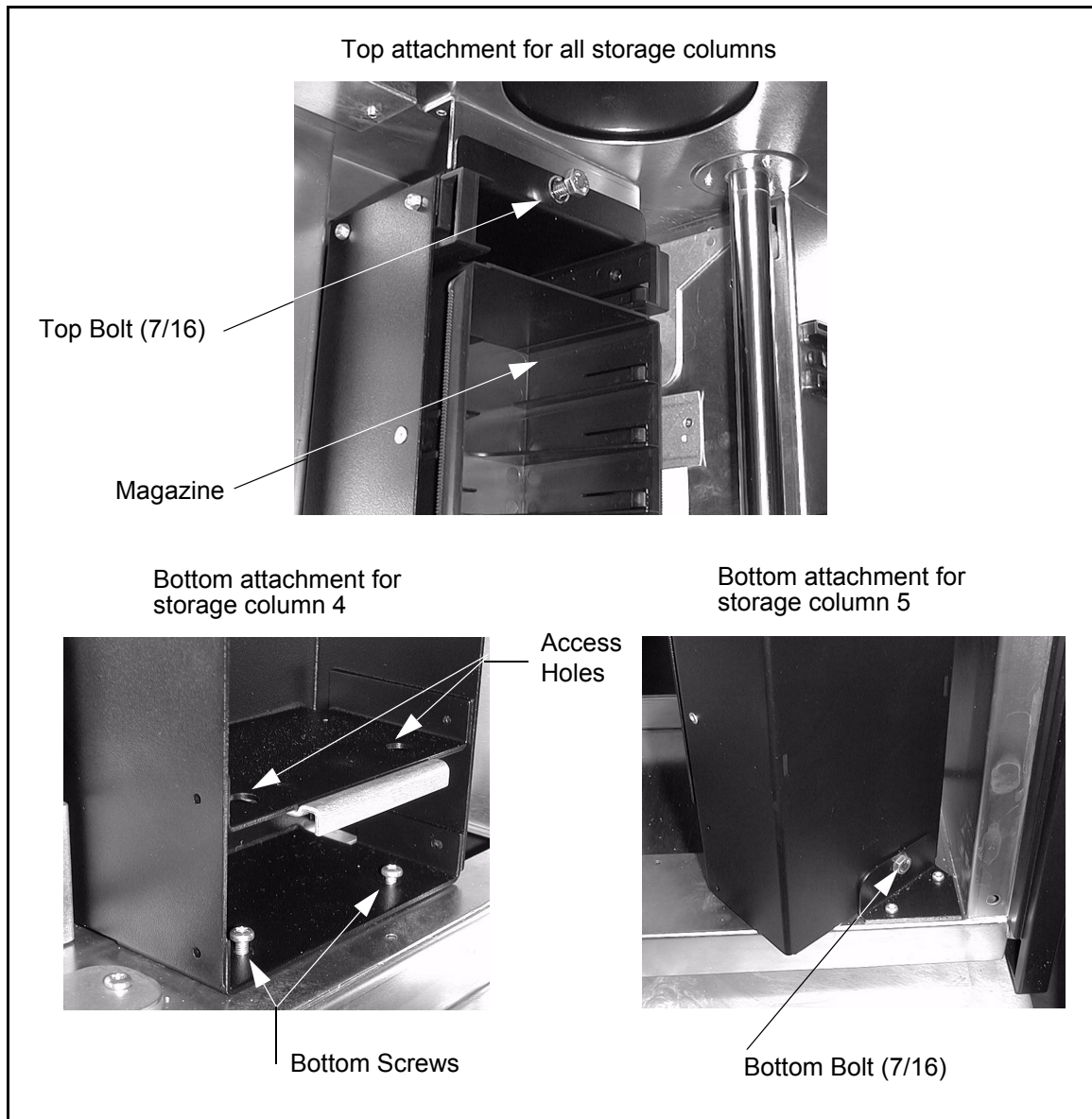

### Tools required:

- 11mm or 7/16 nut driver
- T20 Torx driver
- flashlight

- 1 Turn off the library by turning off both the front (first) and then the rear power switches.

- 2 Open the library front door. If necessary, move the picker assembly up the Y-axis to allow room. Slide the storage column in place.
- 3 Perform one of the following two steps depending on the column you are installing:
  - If you are installing column 4, use the T20 Torx wrench to tighten the two bottom hex screws that attach the storage column to the bottom chassis.
  - If you are installing column 5, use the 7/16 nut driver to tighten the bolt that attach the storage column to the bracket.
- 4 Install the top bolt using the 7/16 nut driver.
- 5 Place the magazines in the storage column.

## Partitioning Your Library

---

In Drive Control Path libraries, you can divide the drives and storage slots into up to three partitions. Partitioning the library allows the server to run different applications in each partition and mixing LTO drives within your library. You can install different generations of LTO drives in your library; however, the drive types cannot be mixed within the same partition. Partitions cannot share drives or storage slots. An exception to the sharing restrictions are cleaning tapes, which can be shared among all partitions.



**Note**

You can enable the partitioning feature after drives are installed and the control path feature is enabled.

Path: **Main Menu > More > Setup > Library > Partitions**

- 1 From the main menu, select **More** and then select **Setup** and then select **Library**. Select **Partition**.
- 2 The number of partitions appears on the panel.
- 3 To change the quantity of partitions, press **Next** until the quantity of partitions that you want displays. Press **OK**.
- 4 Reboot the library to activate the changes.

## Control Path

Control paths are logical paths into the library through which a server sends SCSI command to control the actions of the partition. Additional control paths reduce the likelihood of a the entire library to fail if one partition should go down.

## Configuring AutoCleaning

---

In most configurations, drive cleaning is controlled through the host; however, if desired, the library has an AutoClean feature that enables the library to control drive cleaning. (Host controlled drive cleaning is the default condition.)

Drive cleaning requires cleaning cartridges to be imported into the library. (Note that cleaning cartridges are imported differently than regular tape cartridges.) A total of three cleaning cartridges can be imported. These cartridges are stored in fixed slots located at the top of columns 2, 4, and 5. These slots are not counted as part of the slot capacity of the library, are not included in the report of storage elements, and are not addressable to SCSI hosts.



**Note**

A DLT cleaning tape cannot be used in an SDLT drive.

## Working with AutoClean

AutoClean allows the library to clean a drive without instruction from a host.



### Note

If the mailbox is configured as storage, the AutoClean function cannot be enabled.

As AutoClean does not require host intervention, it should only be enabled if the host application does not or is not configured to control drive cleaning. The cleaning operation is transparent to the host application and will only occur when a drive requests to be cleaned. The host application will get a delayed response until the cleaning operation is complete.

AutoClean requires at least one cleaning cartridge and a communication interface to the drive with the ability of the drive to indicate that cleaning is needed. If AutoClean is enabled, the cleaning slots will be inventoried by touch.

### Enabling/Disabling AutoClean

Use **AutoClean** to enable or disable the AutoClean feature. (Disabling AutoClean will stop all cleaning inquiries to the drive.) Be sure to import cleaning cartridges into your library before enabling AutoClean.

Path: **Main Menu > More > Setup > Library > AutoClean**

- 1 From the main menu, select **More**. Select **Setup** and then select **Library**. Select **AutoClean**.
- 2 Select **Enable** or **Disable** to check or clear the box.  
A checked box indicates AutoClean is enabled.
- 3 Select **OK**.



# 5

## Using the Operator Panel

---

You can initiate all library functions through the operator panel. In addition, the operator panel provides access to library status information.

### Understanding the Operator Panel

---

As shown in [Figure 13](#) on page 38, the operator panel is divided into five areas:

- Mailbox indicator area
- Information area
- Drive status area
- Message area
- Button area



#### Note

In the following graphic, shaded areas are for reference only. Your screen may differ depending on the configuration and type of media installed in your library. For example, the operator panel below displays an LTO library with a bulk load mailbox.

**Figure 13** Operator Panel Areas

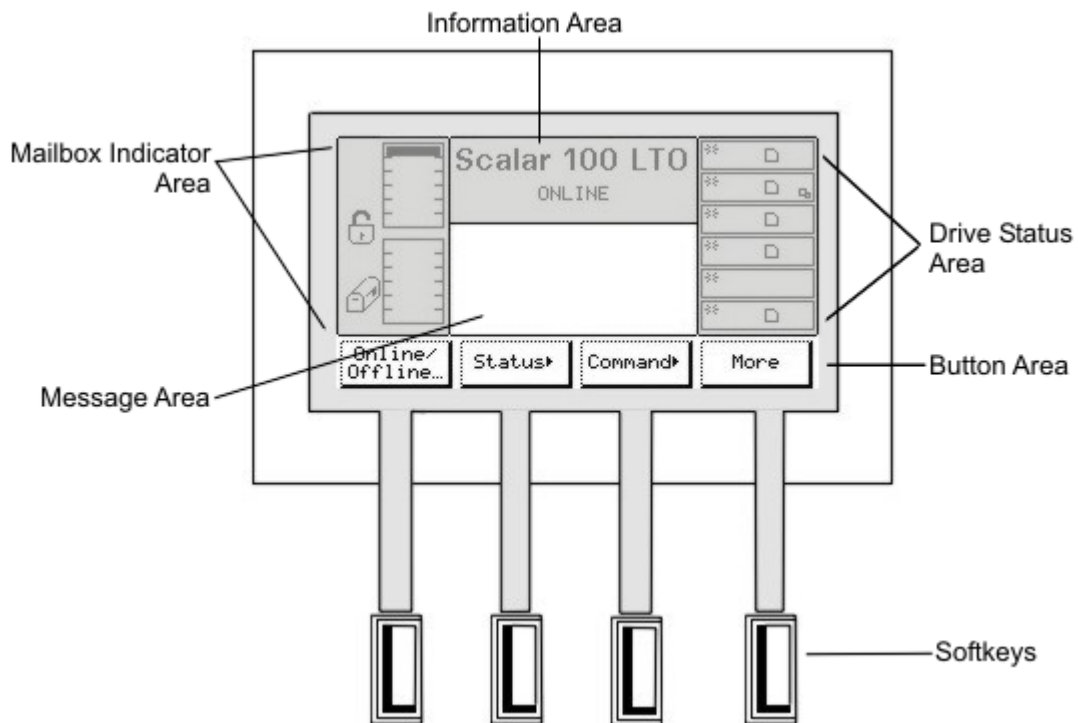

## Getting General Library Information

The information area provides general library information:

- Library name
- Media type (Although the media type appears, the drive type is not. For example, DLT appears for SDLT-320 libraries.)
- ONLINE/OFFLINE status
- Status or attention messages
- Current day of the week, date (month/day/year), and time



## Getting Drive Status Information

The drive status area provides constant drive status. [Table 2](#) on page 39 provides an illustration and description of the icons associated with the drive status area.

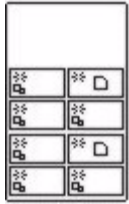
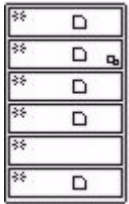
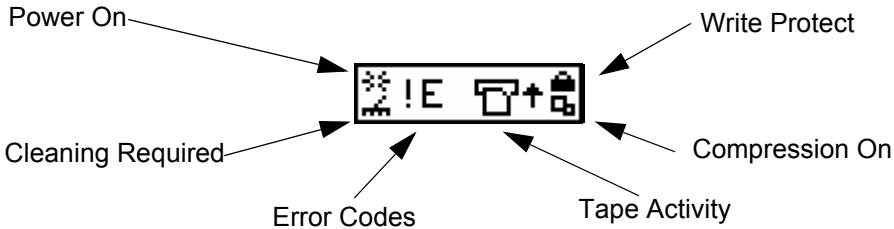
**Table 2** Drive Status Area Indicators







| Indicator   | Description   |
|---|---|
|    | <p>Represents AIT drive modules.</p>  |
|    | <p>Represents DLT, LTO, and SDLT drive modules.</p>                                     |
|  |   |
| <p>Drive Present</p>  | <p>If a tape drive is present (in the drive module), the drive area is outlined.</p>    |
| <p>Power On</p>   | <p>If the tape drive is turned on, the Power On indicator appears.</p>                  |
| <p>Cleaning Required</p>  | <p>If the tape drive cleaning is required, the Cleaning Required indicator appears.</p> |

**Table 2** Drive Status Area Indicators

| Indicator                    | Description   |   |
|------------------------------|---|---|
| Error Code (LTO drives only) | If a drive error condition exists, an error code appears. All errors are preceded by the character “!” followed by the drive error code. “!...” indicates drive failures detected by the library and the drive is not capable of reporting the error. |   |
|                              | !0  | No Error. This code appears when power is cycled on the drive or when diagnostics have finished running and no error occurred.  |
|                              | !1  | A cooling problem has occurred.   |
|                              | !2  | A power problem has occurred.   |
|                              | !3  | A firmware problem has occurred. The drive determined that a firmware error occurred.   |
|                              | !4*   | A firmware or drive problem has occurred.   |
|                              | !5*   | A drive problem has occurred. The drive determined that a drive hardware failure occurred. To prevent damage to the drive, the drive may not allow you to insert a cartridge until the drive is powered off, then on. |
|                              | !6*   | A drive problem has occurred. The drive determined that an error occurred, but could not isolate the error to faulty hardware or data cartridge.  |
|                              | !7*   | A media error has occurred. The drive determined that an error occurred because of a faulty tape cartridge.   |
|                              | !8*   | A drive SCSI bus error has occurred. The drive determined that a failure occurred in the drive hardware or in the SCSI bus.   |
|                              | !9  | A drive or RS-422 error has occurred. The drive determined that a failure occurred in the drive hardware or in the RS-422 connection.   |
| !C                           | Drive cleaning is required.   |   |
| Compression On               | If the tape drive is compressing data on tape, the Compression On indicator appears.  |   |
| Write Protect                | If the tape is write protected, the Write Protect indicator appears.  |   |
| Tape Activity                |    | A tape drive is loading a cartridge.  |
|                              |    | A tape drive has a cartridge loaded.  |
|                              |    | A tape drive is rewinding a cartridge.  |



**Table 2** Drive Status Area Indicators

| Indicator | Description   |  |
|-----------|---|--|
|           |  | A tape drive is unloading a cartridge.         |
|           |  | A tape drive has unloaded a cartridge.         |
|           |  | A tape drive is reading data from a cartridge. |
|           |  | A tape drive is writing data to a cartridge.   |
|           |  | A tape drive is erasing data from a cartridge. |
|           |  | A tape drive is locating data on a cartridge.  |

\*Please call ATAC for assistance in interpreting these errors as they may be caused by erroneous signals from the drive.

## Working with Buttons

The button area is a dynamic area of the operator panel. Depending on the menu, the buttons available here will change. To make a selection, press the appropriate soft key below that button in the button area.

## Getting Library Messages

The message area of the operator panel displays six lines of text, graphic representations, or a combination of both to show interactive dialog boxes, special messages, alerts, and library configurations.

If an error or operator intervention message occurs, refer to [Troubleshooting and Help](#) on page 97.











## Getting Mailbox Status

The mailbox indicator area provides constant status on the library mailbox. The icons displayed in the mailbox indicator area and their meanings are described in [Table 3](#).

**Table 3** Mailbox Indicator Area Icons

| Media Type | Indicator   | Description  |
|------------|---|--|
| All        |  | This indicator appears if the host has issued a <b>PREVENT/ALLOW MEDIUM REMOVAL</b> SCSI command and locked the mailbox. |

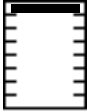
**Table 3** Mailbox Indicator Area Icons

| Media Type | Indicator   | Description   |
|------------|---|---|
| All        | <br>  | <p>This indicator appears if the mailbox is locked. The mailbox can be locked by either of the following conditions.</p> <ul style="list-style-type: none"> <li>• The host issues a <b>PREVENT/ALLOW MEDIUM REMOVAL</b> SCSI command and locks the mailbox</li> <li>• The Scalar 100 is accessing a mailbox slot.</li> <li>• The mailbox has been configured as all storage.</li> </ul> <p>This indicator appears if the mailbox is unlocked.</p>   |
| All        | <br><br><br><br><br> | <p>These indicators are displayed on screen for the six mailbox states.</p> <ul style="list-style-type: none"> <li>• State 1: The mailbox door is closed. Any cartridge in the mailbox has been inventoried.</li> <li>• State 2: The mailbox door is partially open. Any cartridge in the mailbox has previously been inventoried.</li> <li>• State 3: The mailbox door is fully opened. Any cartridge in the mailbox has previously been inventoried. You can now insert a cartridge to be imported.</li> <li>• State 4: The mailbox door is closed. A cartridge has been exported and has not been removed.</li> <li>• State 5: The mailbox door is partially open. A cartridge has been exported and has not been removed.</li> <li>• State 6: The mailbox door is fully open. A cartridge has been exported and has not been removed. While in this state, you can remove an exported cartridge.</li> </ul> |
| AIT        | <br><br>   | <p>These indicators are displayed on screen for all types of front door panel storage.</p> <ul style="list-style-type: none"> <li>• Type 1: A mailbox indicator showing a cartridge indicated by the black slot. A total of 16 slots are available with 8 slots in each magazine.</li> <li>• Type 2: A two slot mailbox indicator.</li> <li>• Type 3: A continuous storage indicator. A total of 8 slots per magazine are available.</li> </ul>   |

**Table 3** Mailbox Indicator Area Icons

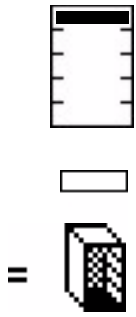
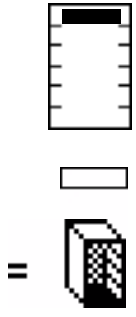
| Media Type | Indicator  | Description  |
|------------|--|--|
| DLT/SDLT   |   | <p>These indicators are displayed on screen for all types of front door panel storage.</p> <ul style="list-style-type: none"> <li>• Type 1: A mailbox indicator showing a cartridge indicated by the black slot. A total of 10 slots are available.</li> <li>• Type 2: A single slot mailbox indicator.</li> <li>• Type 3: A continuous storage indicator. A total of 10 slots are available.</li> </ul>   |
| LTO        |  | <p>These indicators are displayed on screen for all types of front door panel storage.</p> <ul style="list-style-type: none"> <li>• Type 1: A mailbox indicator showing a cartridge indicated by the black slot. A total of 12 slots are available with six slots in each magazine.</li> <li>• Type 2: A single slot mailbox indicator.</li> <li>• Type 3: A continuous storage indicator. A total of 12 slots are available with six slots in each magazine.</li> </ul> |

## Menu Guidelines

All menus and resulting options are grouped according to function. Some options are followed by special characters. The special characters include:

- A keyword leading to another menu is followed by a small black arrow. Example: ►
- A keyword leading to a dialog box is followed by three closely spaced dots.
- A keyword leading to an immediate action has no special character.
- Most fields on the menus, submenus, dialog boxes, and screens are read only. Those fields that are read/write are shown in white type over a black background. For example, during Export operations, cartridge selection is indicated as **ON**

## Using the Main Menu

---

The main menu is the first interactive menu displayed after you turn on the library. From this menu you can run all commands. Throughout this manual, all procedures begin from this menu.

**Figure 14** Main Menu (initial screen)

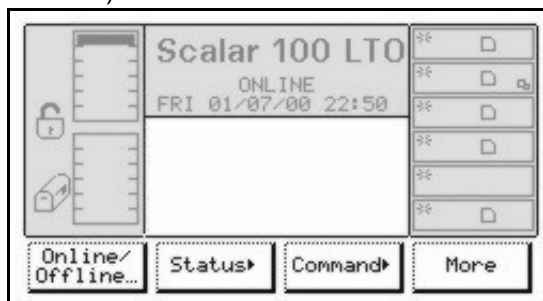

Pressing **More** displays additional options. **Back** returns you to the initial screen.

**Figure 15** Main Menu (more options)

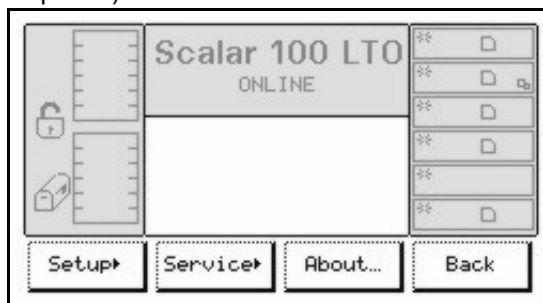

## The Menu Tree

---

The operator panel menu tree appears in [Figure 16](#) on page 45.

Figure 16 Operator Panel Menu Tree

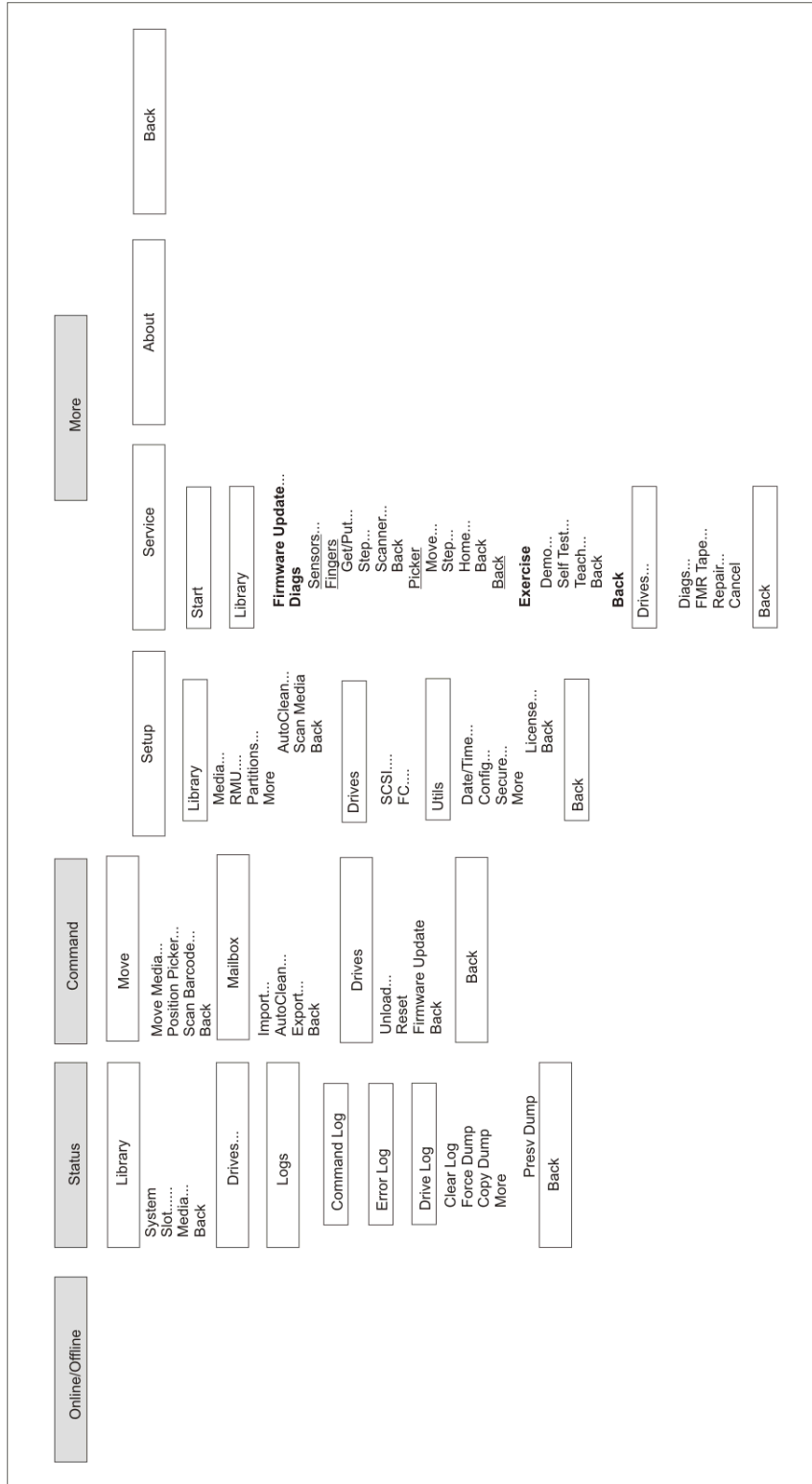

## Using Commands that Require an Offline State

---

The options available from the **Command** and **Service** menu require that the library be Offline. If you attempt these commands while the library is Online, you are prompted to take the library into an Offline state. Alternatively, you can put the library into an Offline state before you begin, by following the procedure below.

You should also put your library into an Offline state before turning off the library.

- 1 From the main menu, select **Online/Offline**.
- 2 Select **OK**.

The information area displays the Offline status.

# 6

## Getting Information

When working with your library, you will often need information about your library such as how many slots are filled or what firmware levels are currently running. Most of this information is available through the **Library** and **About** menus.

### Viewing Library Information

Most of the library information is obtained through the **Library** menu. From the **Library** menu, you can check overall library information, information on a specific slot, and information on a specific tape cartridge.

However, you can also get information through the **About** menu, such as the serial number and the firmware levels.

### Getting Library Statistics

Use **System** to get statistical information about your library, such as how many slots are full and how many lifetime moves have occurred.

A complete list of the information available through this command appears in [Table 4](#).

**Table 4** Available Library Information

| Field         | Value <sup>a</sup> | Description  |
|---------------|--------------------|--|
| Storage slots | Full: 0 to 72      | The number of full slots.  |
|               | Empty: 0 to 72     | The number of empty slots.   |
| Mailbox slots | Full: 0 to 12      | The number of filled mailbox slots.  |
|               | Empty: 0 to 12     | The number of empty mailbox slots.   |
| Drives        | Full: 0 to 6       | The number of filled drive slots.  |
|               | Empty: 0 to 6      | The number of empty drive slots.   |
| Moves         | 0 to x             | The current number of slot to slot moves over the lifetime of the library. |
| IO accesses   | 0 to 65535         | The lifetime number of mailbox door openings.                              |

**Table 4** Available Library Information

|             |            |   |
|-------------|------------|---|
| Get retries | 0 to 65535 | The lifetime number of recovery retries on a get command. |
| Put retries | 0 to 65535 | The lifetime number of recovery retries on a put command. |

a. The storage slot, mailbox slot, and drive maximum value may be different for your library, depending on your configuration and your drive type.

Path: **Main Menu > Status > Library > System**

- From the main menu, select **Status** and then select **Library**. Select **System**.

The library information appears. Refer to [Table 4](#) on page 47 for information on each of these fields.

## Getting Firmware and Serial Number Information

Use **About** to display the library serial number and the application and boot firmware levels. This includes the library, picker, display, drive, and RMU.

Path: **Main Menu > More > About > (Details)**

- 1 From the main menu, select **More**. Select **About**.

The library serial number and library firmware level appears.

- 2 Select **Details**.

The library, picker, and display application and boot codes are displayed.

- 3 Continue selecting **Details** to scroll through the available information:



**Note** All application and boot code entries should be of the same version and at the highest level.

- **MainAppl** — the library application code.
- **PickAppl** — the picker application code.
- **DispAppl** — the display application code.
- **MainBoot**— the library boot code.
- **PickBoot** — the picker boot code.
- **DispBoot** — the display boot code.
- **Sled<x>Appl** — the drive module application code, where X is the drive module number.
- **Sled<x>Boot** — the drive module boot code, where X is the drive module number.
- **RMU Appl** — the Remote Management Unit (RMU) application code.



## Getting Sensor Information

Use **Sensors** to view library sensor status. This option displays the real time status of the sensors in the library.

Path: **Main Menu > More > Service > Library > Diags > Sensors**

- From the main menu, select **Service** and then select **Library**. Select **Diags** and then **Sensors**.

The **Sensors** dialog box appears, with the following information:



Note

For information on using **Lock/Unlock** to lock or unlock the mailbox, refer to [Locking/Unlocking the Mailbox](#) on page 73.

| Field     | Value | Description                               |
|-----------|-------|---|
| PwrFan    | 0     | The power supply fan is not running.      |
| PwrFan    | 1     | The power supply fan is running.          |
| PwrSply   | 0     | Additional power supply is not installed. |
| PwrSply   | 1     | Additional power supply is installed.     |
| DrvRmvd   | 0     | Drive has not been removed.               |
| DrvRmvd   | 1     | Drive has been removed.                   |
| GrpThrm   | 0     | Gripper thermometer is not installed.     |
| GrpThrm   | 1     | Gripper thermometer is installed.         |
| GrpClsd   | 0     | Gripper is open.                          |
| GrpClsd   | 1     | Gripper is closed.                        |
| IE Lock   | 0     | Mailbox is unlocked.                      |
| IE Lock   | 1     | Mailbox is locked.                        |
| IE Open   | 0     | Mailbox is closed.                        |
| IE Open   | 1     | Mailbox is open.                          |
| IE Closed | 0     | Mailbox is open.                          |
| IE Closed | 1     | Mailbox is closed.                        |
| DoorOpn   | 0     | Front door is closed.                     |
| DoorOpn   | 1     | Front door is open.                       |

## Getting Slot Information

Use **Slot** to get statistical characteristics of a slot. The information available through this command appears in [Table 5](#) on page 50.



Note

For more information on slot numbering, refer to [Slot Numbering](#) on page 9.

Path: **Main Menu > Status > Library > Slot**

**Table 5** Available Slot Information

| Field       | Value                    | Description   |
|-------------|--------------------------|---|
| Slot        | 1 to 5                   | Indicates the location of the tape cartridge column.  |
|             | A to C                   | Indicates the location of the tape cartridge magazine.  |
|             | 1 to 8                   | Indicates the location of the tape cartridge row.<br>The maximum value depends on your configuration. |
| Status      | Empty                    | A tape cartridge is not present.  |
|             | Full                     | A tape cartridge is present.  |
| Volser      | 0 to 9, A to Z           | Indicates the barcode number.   |
| Source      | Column/Magazine/<br>Slot | Indicates the home position of the tape cartridge.  |
| Valid       | Yes                      | The slot can be used.   |
|             | No                       | The slot cannot be used.  |
| Total Puts  | 0000000 to 9999999       | Indicates the total number of put operations.   |
| Put Retries | 0000000 to 9999999       | Indicates the number of put retry operations.   |
| Get Retries | 0000000 to 9999999       | Indicates the number of get retry operations.   |
| Reserved    | Yes                      | Indicates the slot is reserved by a SCSI host.  |
|             | No                       | Indicates the slot is not reserved by a SCSI host.  |
| Reserve ID  | 00 to 72                 | Indicates the reserve ID.   |
| Reserved by |                          | Indicates the ID of the reserving host.   |
| X-POS GET   | 00000000 to<br>99999999  | Indicates the rotary position the picker uses to retrieve a tape cartridge from the selected slot.    |
| Y-POS GET   | 00000000 to<br>99999999  | Indicates the vertical position the picker uses to retrieve a tape cartridge from the selected slot.  |

**Table 5** Available Slot Information

| Field     | Value                | Description  |
|-----------|----------------------|--|
| Z-POS GET | 00000000 to 99999999 | Indicates the horizontal position the picker uses to retrieve a tape cartridge from the selected slot. |
| X-POS PUT | 00000000 to 99999999 | Indicates the rotary position the picker uses to insert a tape cartridge into the selected slot.       |
| Y-POS PUT | 00000000 to 99999999 | Indicates the vertical position the picker uses to insert a tape cartridge into the selected slot.     |
| Z-POS PUT | 00000000 to 99999999 | Indicates the horizontal position the picker uses to insert a tape cartridge into the selected slot.   |

- 1 From the main menu, select **Status** and then select **Library**. Select **Slot**.

The **Slot** dialog box appears.

- 2 With **Select Column** selected, press **Change Column** until the arrow points to the column that contains the target slot. Press **Next**.

If you select the drive column, no slot or magazine parameters are available. The menu will revert from the drive parameter back to the change column parameter.

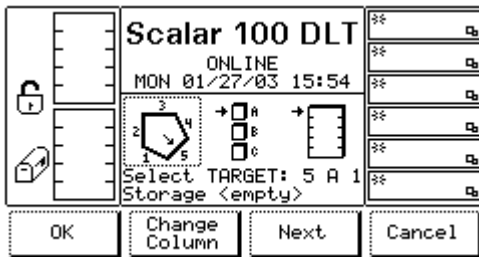

- 3 With **Magazine** selected, select **Change Magazine** until the arrow points to the target magazine. Press **Next**.

- 4 With **Slot** selected, press **Change Slot** until the arrow points to the target slot.

The **Select TARGET** line displays the target slot. For example, the display below has slot 5C5 selected as the target.

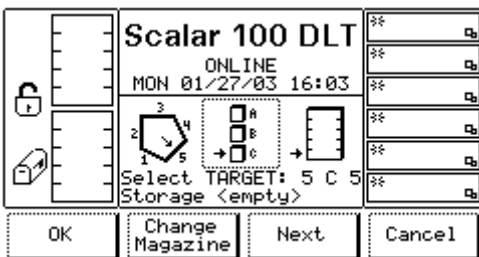

- 5 When the correct slot is selected, select **OK**.

The slot information appears.

- 6 Press **Next** to scroll through the available information.

## Getting Tape Cartridge Information

Use **Media** to get information about the tape cartridges in the library. You can select the tape cartridge using the volser number and the current physical location of the tape cartridge. The information available through this command appears in [Table 6](#).



**Note** For more information on slot numbering, refer to [Slot Numbering](#) on page 9.

Path: **Main Menu > Status > Library > Media**

**Table 6** Available Media Information

| Field   | Value          | Description  |
|---------|----------------|--|
| Volser  | 0 to 9, A to Z | Indicates the barcode number.<br><br>(To include in this list the barcode number of tape cartridges currently in tape drives, refer to <a href="#">Reading Barcodes of Media in Tape Drives</a> on page 70.) |
| Column  | 1 to 5         | Indicates the location of the tape cartridge column.   |
| Section | A to C         | Indicates the location of the tape cartridge magazine.   |
| Row     | 1 to 6         | Indicates the location of the tape cartridge slot.   |
| Cell    | 0 to 105       | Indicates the location of the tape cartridge cell. Starting from the top location in the mailbox, counting down continuously to each section.  |

- 1 From the main menu, select **Status** and then select **Library**. Select **Media**.

The **Media** dialog box displays. The dialog box displays the media cartridges currently in the library by their barcode and current location (column/magazine/row).

- 2 Press **Select** and then use the **Up** and **Down** buttons to select the media cartridge.
- 3 Press **Select**.

The selected media cartridge's information appears.

## Viewing Drive Information

Use **Drives** to get information about a drive. The information available through this command appears in [Table 7](#) on page 53.

Path: **Main Menu > Status > Drives**

**Table 7** Available Drive Information

| Field   | Value  | Description   |
|---------|--|---|
| Drive   | 01 to 08   | The number of the drive currently selected.                     |
| Type    | AIT, AIT-3, LTO, IBM LTO-2, LTO-3, DLT, DLT 8000, SDLT, SDLT320, SDLT600 | The type of drive currently selected.                           |
| Ser Num | A to Z, 0 to 9   | The serial number of the drive currently selected.              |
| Version | A to Z, 0 to 9   | The current level of firmware installed on the drive displayed. |
| SCSI ID | 00 to 15   | The SCSI ID of the currently selected drive.                    |

- 1 From the main menu, select **Status** and then select **Drives**.  
The **Drive** information appears.
- 2 To view a different drive, select **Change Drive**.  
The new target drive's information is automatically displayed.

## Getting Logs

---

**Logs** provides access to the available logs, which include the command, error, and drive logs. You can view the logs on the operator panel or print the logs by sending them to a serial port.

These logs are also available through the Remote Management Unit (RMU).

## Printing Logs (HyperTerminal)

When working with logs, you have the option to send the log to a serial port. This option is usually indicated as **Print** in the operator panel. To send a log, you must have HyperTerminal running when you select **Print**.



**Note**

These logs are also available as diagnostic files through the RMU. If the RMU is used, you do not need a serial connection.

- 1 Connect straight through the serial cable from the host to the serial port located on the library controller. (A null modem cable will not work in this procedure.)
- 2 Start HyperTerminal and configure it with the following parameters:
  - Bits per second: 38400
  - Data bits: 8
  - Parity: None
  - Stop bits: 1
  - Flow control: None
  - Emulation: ANSI



Note

Refer to the HyperTerminal documentation for information on how to configure and run HyperTerminal.

## Getting the Command Logs

The command log is a history of all library operations. A maximum of 50 library operations are stored. You can print the log by sending it to the serial port.

Path: **Main Menu > Status > Logs > Command Log**

- 1 From the main menu, select **Status** and then select **Logs**. Select **Command Log**.

The most recent command displays first. Note that the explanation may be useful only when you contact ATAC.

- 2 Use **Next** or **Previous** to scroll through the stored commands.
- 3 If you want to send the entire log to a serial port, start HyperTerminal (refer to [Printing Logs \(HyperTerminal\)](#) on page 53). Select **Print** and then select **OK**.

## Getting Error Logs

The error log is a history of error conditions that have occurred. A maximum of 213 errors are kept in the log. You can print the log by sending it to the serial port.

Path: **Main Menu > Status > Logs > Error Log**

- 1 From the main menu, select **Status** and then select **Logs**. Select **Error Log**.

The most recent error displays first. The following information is provided:

- Date (Month/Day/Year) — The date of the error.
- Time (Hrs:Mins:Secs) — The time of the error.
- Type (text) — Useful only to ATAC.
- Error (Hexadecimal number) — Useful only to ATAC.
- Modifier (Hexidecimal number) — Useful only to ATAC.
- Board (any PCBA) — The PCBA associated with the error.

- 2 Use **Next** or **Previous** to scroll through the errors.
- 3 If you want to send the entire log to a serial port, start HyperTerminal (refer to [Printing Logs \(HyperTerminal\)](#) on page 53). Select **Print** and then select **OK**.

## Getting Drive Logs

The drive log is a history of drive error conditions that have occurred. You can print the log by sending it to the serial port.

Path: **Main Menu > Status > Logs > Drive Log**

- 1 From the main menu, select **Status** and then select **Logs**. Select **Drive Log**.

- Using **Change Drive**, select the drive whose log you want to view.

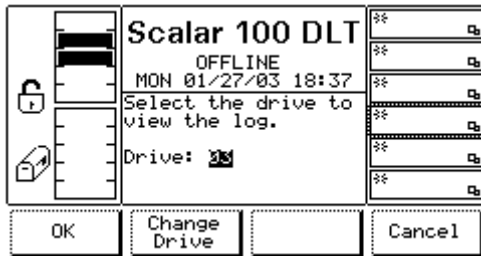

- Select **OK**.

The drive log contains:

- Num (0 to 9) — Error ID
- Error (0 to 9) — Error Type
- FSCI (0000 to 9999) — Fault symptom code 1
- FSC2 (0000 to 9999) — Fault symptom code 2

- Use **Next** and **Previous** to scroll through the drive errors.

- If you want to clear the log, or copy the log to a tape cartridge in the library, select **Options**.

- To clear the log, select **Clear Log**. Select **OK**.
- To send the log to a tape cartridge, do the following:
  - Select **Force Dump**.
  - Select **Copy Dump**.
  - Put a scratch cartridge in slot 1A1.
  - After the TEACH and INVENTORY, select **OK**.
  - The tape is placed into a drive, and the log is copied to the tape cartridge. When done, the tape is placed back into slot 1A1. Select **OK**.

## Clear Log

This option is used to erase the current drive error log.

Path: **Main Menu > Status > Logs > Drive Logs > Clear Log**

- From the main menu, select **Status** and then select **Logs** and then select **Drive Logs**. Select **Clear Log**.
- Press the button beneath the desired softkey.
  - Press the button beneath the **OK** softkey to clear the current drive error log. The Clear Drive Error Log Response Dialog appears.
  - Press the button beneath the **Cancel** softkey to cancel the action.
- Press the button beneath the **OK** softkey.

## Force Dump

This option is used to dump a drive error log to a hyperterminal.

Path: **Main Menu > Status > Logs > Drive Log > Options > Force Dump**

- 1 From the main menu, select **Status** and then select **Logs** and then select **Drive Log**. Select **Force Dump**.
- 2 Press the button beneath the desired softkey.
  - a. Press the button beneath the **OK** softkey to transfer the drive error log to a hyperterminal.
  - b. Press the button beneath the **Cancel** softkey to cancel the action.
- 3 Press the button beneath the **OK** softkey

## Copy Dump

The Copy Dump option is used to copy the drive error log onto a tape cartridge. The Copy Dump option can be accessed whether the mailbox is configured as storage or as a mailbox slot.

Path: **Main Menu > Status > Logs > Drive Log > Copy Dump**

- 1 From the main menu, select **Status** and then select **Logs** and then select **Drive Log**. Select **Copy Dump**.
- 2 Perform one of the following steps:
  - When there is a scratch (blank) tape cartridge in the mailbox, press the softkey under **OK** when the Overwrite Dialog appears.
  - When the mailbox is empty, open the mailbox. Place a scratch (blank) tape cartridge in it. Close the mailbox. After you confirm that the tape in the mailbox should be overwritten, the copy dump begins.
  - When the mailbox is configured as storage, press **Cancel** when the Scratch Tape Dialog appears. Open the main door, and place a scratch tape cartridge in slot [1 A 1], which is the top slot in the mailbox. Close the main door.
    - After the door is closed, the library executes the TEACH and INVENTORY procedures. When the TEACH and INVENTORY procedures are finished, restart the copy dump from the Options submenu.

 **Note** Wait at least five seconds before closing the mailbox door.

- 3 Press the button beneath the **OK** softkey.

 **Note** An error message appears if a higher generation scratch tape is used in a lower generation drive.

The Command In Progress Dialog appears.

The Operator Panel indicates the library is currently loading a cartridge and the picker takes the cartridge from the mailbox and places it into a drive.

The Operator Panel then indicates the diagnostic is now in progress and the drive copies the drive log dump to the tape.

When the dump has been completely copied to the tape, the Operator Panel indicates the library is currently unloading a cartridge. The picker removes the tape from the drive and places it back into the first slot of the mailbox.

After the operation has been completed the Command Complete Dialog appears.

- 4 Press the button beneath the **OK** softkey.

## Preserve Dump Dialog

Path: **Main Menu > Status > Logs > Drive Log > More > Preserve Dump**



- 1 From the main menu, select **Status** and then select **Logs** and then select **Drive Log**. Select **More** and then select **Copy Dump**.
- 2 The library sends a command to cause the drive to copy a drive dump to non-volatile memory on the drive. A service technician can extract the information for analysis.
- 3 A message is posted to show that the drive dump is being saved.



# 7

## Running your Library

---

For everyday tasks, the **Command** menu is the most frequently used menu. Most actions associated with this menu are related to physical movement in the library. For example, importing tape cartridges or moving a tape cartridge to a specific slot are considered everyday tasks. These commands all require the library to be in an Offline state.

### Turning on the Library

---

Use the following steps to turn on the library.

- 1 If you have not unlocked the front door and cleared the area of packaging materials, do so now. (Refer to [Unpacking your Library](#) on page 14).
- 2 Turn on the rear power switch and then turn on the front power switch. The library firmware will automatically begin the teach and inventory processes.
- 3 Turn on your host computer and verify SCSI communication. (Refer to [Verifying Communication with the Host](#) on page 22.)
- 4 Once the inventory and teach process is complete, we recommend you run demo for at least five cycles. To do this, place the library in an Offline state, and then chose **Main Menu > Service > Library > Exercise > Demo**.

### Turning off the Library

---

The library can be shut down normally or by the emergency shutdown method. Except in emergencies, stop the library with the normal shutdown procedure before switching off the rear power switch. ADIC is not responsible for damage caused by improper use of the rear power switch. All risk lies entirely with the user.



**CAUTION**

**In emergency situations, immediately switch off the rear power switch. This removes all power from the library.**

- 1 If the library is in an ONLINE state, from the main menu, select **Online/Offline**.
- 2 Press **OK**. Visually confirm that the library has changed to the OFFLINE state.

- 3 Turn off the front power switch.
- 4 Turn off the rear power switch.

## Moving Tape Cartridges

Use **Move Media** to move tape cartridges between slots. This is useful for instances where you want to group a series of cartridges in the library.



**CAUTION**

**An error message appears if an unlabeled LTO Gen 2 tape is moved to an LTO Gen 1 drive.**

Path: **Main Menu > Command > Move > Move Media**

- 1 From the main menu, select **Command** and then select **Move**. Select **Move Media**.
- 2 With **Select Column** selected, press **Change Column** until the arrow points to the source column. Press **Next**.

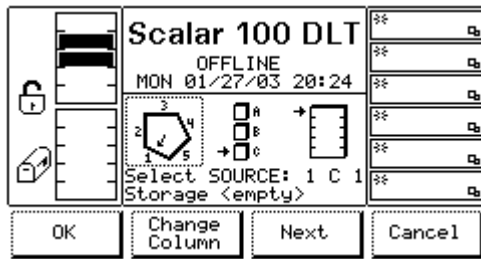

- 3 With **Magazine** selected, select **Change Magazine** until the arrow points to the source magazine. Press **Next**.
- 4 With **Slot** selected, press **Change Slot** until the arrow points to the source slot.

The **Select SOURCE** line displays the source slot. For example, the display below has slot 1C3 selected as the source slot.

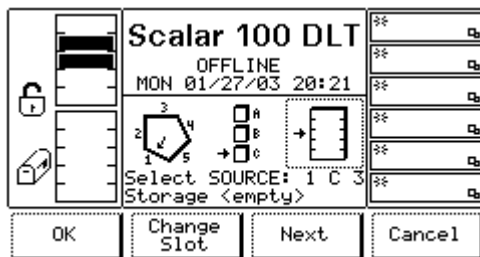

- 5 When the correct slot is selected, select **OK**.
- 6 Select the target slot by repeating the same process.
- 7 Press **OK**.

The tape cartridge is moved.

## Moving the Picker

---

When working with your library, you may want to move the picker to specific location in the library so that you can have an unobstructed view of an area or so that you can gain access to a particular spot in the library. To move the picker to a specific location, use **Move Picker**.

Path: **Main Menu > Command > Move > Position Picker**

- 1 From the main menu, select **Command** and then select **Move**. Select **Position Picker**.
- 2 With **Select Column** selected, press **Change Column** until the arrow points to the target column. Press **Next**.

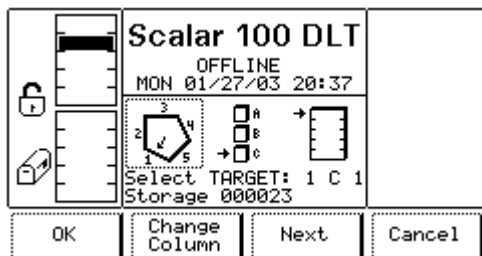

- 3 With **Magazine** selected, select **Change Magazine** until the arrow points to the target magazine. Press **Next**.
- 4 With **Slot Parameter** active, press **Change Slot** until the arrow points to the target slot.  
The **Select TARGET** line displays the target location. For example, the display below has slot 1C3 selected as the target.

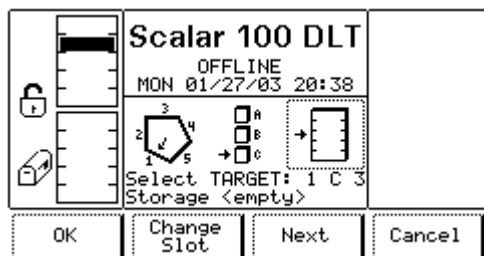

- 5 When the correct location is selected, select **OK**.  
The picker is moved to the specified location.

## Taking Inventory

---

Periodically, you may need to take inventory of the tape cartridges in the library outside of the initial TEACH and INVENTORY that occurs at startup or when the door or mailbox are opened. For example, if there is a discrepancy between the number and location of tape cartridges in the library, you may want to take inventory to re-establish these values. **Scan Barcode** allows you to take inventory of the entire library or a specific set of tape cartridges.

Path: **Main Menu > Command > Move > Scan Barcode**

- 1 From the main menu, select **Command** and then select **Move**. Select **Scan Barcode**.
- 2 With **Select Column** selected, press **Change Column** until the arrow points to the start column. Press **Next**.

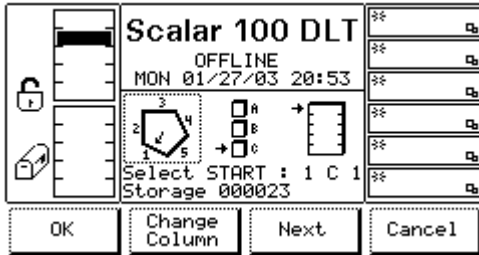

- 3 With **Magazine** selected, select **Change Magazine** until the arrow points to the start magazine. Press **Next**.
- 4 With **Slot** selected, press **Change Slot** until the arrow points to the start slot.

The **Select START** line displays the start location. For example, the display below has slot 1C1 selected as the start location.

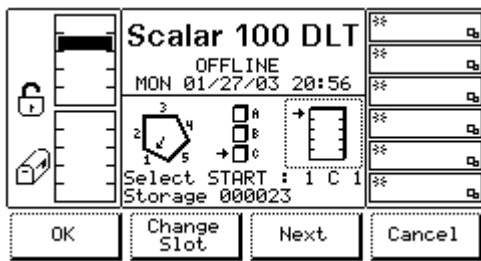

- 5 When the start location is specified, select **OK**.
- 6 Enter the number of slots to scan, using **Up** and **Down**. Press **Next**.
- 7 Specify whether to display the scan results using **Yes/No**.
- 8 Press **OK**.

## Adding/Removing Tape Cartridges

You can add or remove tape cartridges from your library through the mailbox or by manually performing the task. Adding and removing through the mailbox is the preferred method as it does not interrupt library operations.



**CAUTION**

Do not use these procedures to insert or remove cleaning cartridges into the library. Refer to [Working with Cleaning Cartridges](#) on page 64.

## Importing Tape Cartridges

Use **Import** to add tape cartridges to your library through the mailbox. **Import** moves all tape cartridges currently in the mailbox to the first available slots in the library. Using **Import** to insert tape cartridges does not disrupt library operations.

To use this procedure, the mailbox must be unlocked. For more information, refer to [Locking/Unlocking the Mailbox](#) on page 73. In addition, before beginning, ensure the tape cartridges have barcode labels and are not write-protected.



### CAUTION

If the library is partitioned (through the host software), this command could move a tape cartridge into an incorrect partition. After importing, notice where the tape cartridge is placed, and if necessary, move the tape cartridge to a new location using **Move Media**.



### CAUTION

If the cartridge you are importing does not have a barcode label, you must turn on Touch-on-Init. Refer to [Configuring Additional Library Options](#) on page 69.

Path: **Main Menu > Command > Mailbox > Import**

- 1 From the main menu, select **Command** and then select **Mailbox**. Select **Import**.

The picker moves all cartridges in the mailbox to the first available empty slots. Refer to [Slot Numbering](#) on page 9.

- 2 When complete, select **OK**.
- 3 If you want to move the imported tape cartridges to a new location, use **Move Media**.

## Manually Inserting Tape Cartridges

If you need to add a large number of tape cartridges to the library, you probably will want to manually insert them. If you only have a small number of tape cartridges to add, use the **Import** command as it does not interfere with library operations. To do this procedure, the front door must be unlocked or you must have the key. In addition, before starting, ensure the tape cartridges have barcode labels and are not write-protected.



### CAUTION

If your library is partitioned (through the host software), be aware of where you are placing tape cartridges.

- 1 Place the library in an Offline state.  
Refer to [Using Commands that Require an Offline State](#) on page 46.
- 2 If the library door is locked, unlock the door. Open the door, and put the tape cartridges into the slots.
- 3 Close the door. (Lock it if necessary.)

The library executes the TEACH and INVENTORY procedures.

## Exporting a Tape Cartridge

Use **Export** to remove tape cartridges from your library through the mailbox. **Export** takes a specific tape cartridge and places it in the mailbox so that you can remove it from your library. To use this procedure, the mailbox cannot be configured as storage.

Path: **Main Menu > Command > Mailbox > Export**

1 From the main menu, select **Command** and then select **Mailbox**. Select **Export**.

2 Select **OK**.

The panel shows a list of tape cartridges in the library.

3 Press **Select** to begin choosing the tape cartridge(s) you want to export.

4 Use **Next**, **Select**, and **Pages** to choose the tape cartridge(s) you want to export.

Highlighted cartridges will be exported. You can only export as many tape cartridges as your mailbox holds.

5 When complete, press **OK**.

## Manually Removing Tape Cartridges

If you need to remove a large number of tape cartridges, you probably will want to manually remove them. If you only have a small number of tape cartridges to remove, use the **Export** command as it does not interfere with library operations. To do this procedure, the front door must be unlocked or you must have the key.

1 Place the library in an Offline state.

Refer to [Using Commands that Require an Offline State](#) on page 46.

2 If the library door is locked, unlock the door. Open the door, and remove the tape cartridges.

3 Close the door. (Lock it if necessary.)

The library executes the TEACH and INVENTORY procedures.

## Working with Cleaning Cartridges

---

The **AutoClean** menu allows you to import and export cleaning cartridges. It also provides you access to cleaning cartridge information.

For information about how cleaning drives, refer to [Configuring AutoCleaning](#) on page 34.

## Viewing Cleaning Cartridge Status

Use **AutoClean** to get information about the cleaning cartridges in your library, including how many cleaning cartridges are in the library, the number of times a cleaning cartridge has been used, the number of times a cleaning cartridge can be used, and whether AutoClean is active or inactive.

Path: **Main Menu > Command > Mailbox > AutoClean**

1 From the main menu, select **Command** and then select **Mailbox**. Select **AutoClean**.

The **AutoClean** dialog box displays with the following information:

- If the slot is darkened, it means the indicated cleaning slot is full.
- **UseCnt** (00 to 99 or EXP)—indicates the number of times the cleaning cartridge has been used. EXP means the cleaning cartridge is expired.
- **MaxCnt** (50 or EXP)—Indicates the number of time the cleaning cartridge can be used. EXP means the cleaning cartridge is expired.
- **Status** (Active)—Indicates the AutoClean feature is currently active.



## Importing Cleaning Cartridges

Use this command to import cleaning cartridges. You can only import a cleaning cartridge if one of the fixed cleaning cartridge slots is available. If no slots are available, export an existing cleaning cartridge first. This command is only available if you have AutoClean configured.

A total of three cleaning cartridges can be imported. They are stored in fixed slots located at the top of columns 2, 4, and 5.

Path: **Main Menu > Command > Mailbox > AutoClean > Import**

- 1 From the main menu, select **Command** and then select **Mailbox**. Select **AutoClean**.
- 2 Select **Import**.
- 3 Open the mailbox and put a cleaning cartridge into the top slot of the mailbox.



**Note** Only the top slot of the mailbox can be used to import cleaning cartridges.

- 4 Close the mailbox.  
The library executes the TEACH and INVENTORY commands.
- 5 Select **OK**.  
The **Set Use and Max Count** dialog box appears.
- 6 In the **Use-Count** field, use **Up** and **Next** to enter how many times the cleaning cartridge has been used.  
**Max-Count** is a read-only field.
- 7 Select **OK**.
- 8 When the command is complete, press **OK**.

## Exporting Cleaning Cartridges

Use this command to export cleaning cartridges. You can only export a cleaning cartridge if a mailbox slot is available.

Path: **Main Menu > Command > Mailbox > AutoClean > Export**

- 1 From the main menu, select **Command** and then select **Mailbox**. Select **AutoClean**.
- 2 Select **Export**.
- 3 Use **Up** and **Down** to select the desired cleaning cartridge.
- 4 Press **Select**.
- 5 When the command is complete, press **OK**.

## Working with Drives

---

You can unload a drive, reset a drive, or update the drive firmware. Unloading a drive is addressed here. Refer to [Maintaining your Library](#) on page 75 for information on resetting drives and updating drive firmware. For information on cleaning drives, refer to [Configuring AutoCleaning](#) on page 34.

## Unloading a Drive

Use this feature to unload a tape cartridge from a specific drive or all drives. The tape cartridge will be placed in its original slot.

Path: **Main Menu > Command > Drives > Unload**

- 1 From the main menu, select **Command** and then select **Drives**. Select **Unload**.
- 2 Select **Change Drive** to specify the drive to be unloaded, or use **ALL** to unload all the drives.



- 3 Select **OK**.

# 8

## Configuring your Library

---

You can configure your library in many different ways. Configuring includes setting the library SCSI ID, setting the number of retries your library will attempt, and setting whether your mailbox is to be used for import/export functions or for storage. These operations are those that personalize the library to your environment.

### Using AIT WORM Technology

---

Scalar 100 libraries with AIT-3 drives support the Sony® AIT™ WORM (write-once-read-many) technology. WORM technology provides extra data security by prohibiting accidental data erasure. Once written to, WORM recorded information cannot be erased or rewritten (but information can be appended to the end of existing data on a tape cartridge).

To use the WORM recording functionality, the installed library firmware and AIT-3 drive firmware must support this feature. Refer to the compatibility matrix in the library release notes to see which firmware releases should be installed.

When the correct firmware is installed, your library will automatically support WORM whenever you use AIT WORM tape cartridges. (AIT WORM cartridges have a visible “WORM” logo on them). When a standard AIT tape cartridge, a non-WORM tape cartridge, is loaded into a WORM enabled drive, the drive writes in the standard format, meaning the data on the tape can be rewritten and reformatted.

For specific information about the supported WORM tape cartridges, refer to [Specifications](#) on page 111.

### Configuring General Characteristics

---

The general characteristics of the library are configured using **Partitions** and **Config**. The following sections describe how to use these commands.

### Configuring Library Characteristics

Use **Partition** to configure the general characteristics of your library. This includes the following items:

- Setting the SCSI ID or Loop ID of the library — Remember that it is important that each ID be unique from other SCSI devices on the SCSI bus.
- Setting the number of retries — This the number of times the library will attempt to put or get a media cartridge before it gives an error.

- Enabling or disabling parity — This value defaults to enabled and must match the configuration of the host bus adapter.
- Emulating a different library — You can configure your library to emulate other ADIC products. This is useful if your host software recognizes other ADIC products, but not the Scalar 100 (this may happen if, for example, you do not have the correct drivers installed). This feature allows the Scalar 100 to appear like a different library so that the host knows how to communicate with it.



Note

Many other library characteristics are set using **Config**. Refer to [Configuring General Characteristics](#) on page 67 for more information.

Path: **Main Menu > More > Setup > Library > Partition**

- 1 From the main menu, select **More**. Select **Setup** and then select **Library**. Select **Partition**.  
The current and new values display.
- 2 Use **Up**, **Down**, **Next**, and **Yes/No** to enter values in the following fields:
  - **Loop/SCSI ID** — Sets the Loop or SCSI ID of the library. Available Loop/SCSI IDs are 0 to 7.
  - **Retries** — Sets the number of retries. Possible values are 0 to 255.
  - **Parity** — Enables or disables parity. Possible values are **Yes** and **No**.
  - **Library sign-on** — Changes the library sign-on. Possible values are **Scalar 100**, **Scalar DLT 448**, **Scalar 1000**, and **EXB-480**.
- 3 When finished, with **Parity** or **Library sign-on** selected, select **OK**.

|                  |                        |      |        |
|------------------|------------------------|------|--------|
|                  | <b>Scalar 100 DLT</b>  | **   | ▢      |
|                  | OFFLINE                | **   | ▢      |
|                  | TUE 01/28/03 21:03     | **   | ▢      |
|                  | CURRENT NEW            | **   | ▢      |
|                  | SCSI ID: 0 5           | **   | ▢      |
|                  | Retries: 001 005       | **   | ▢      |
|                  | Parity: Yes <b>Yes</b> | **   | ▢      |
| Library sign-on: | **                     | ▢    |        |
| Scalar 100       |                        |      |        |
| OK               | Yes/No                 | Next | Cancel |

- 4 The new values will not take effect until you reboot the library. If you want to reboot now, select **OK**. If you want to wait, select **Cancel**.

|    |  |    |        |
|----|--|----|--------|
|    | <b>Scalar 100 DLT</b>  | ** | ▢      |
|    | OFFLINE  | ** | ▢      |
|    | TUE 01/28/03 21:07   | ** | ▢      |
|    | The new values are set. They will take effect when the library is rebooted. Do you want to reboot now? | ** | ▢      |
|    |  | ** | ▢      |
|    |  | ** | ▢      |
|    |  | ** | ▢      |
| OK |  |    | Cancel |

## Configuring Additional Library Options

Use **Config** to configure additional library characteristics. These characteristics include:

- Choosing whether the operator panel LCD has a backlight.
- Choosing whether or not to enable key strokes sounds when pressing library buttons.
- Setting whether the library scans all barcodes when the library is booted up. Note that the library must either scan or touch all media cartridges when booted.
- Setting whether the library touches all media cartridges when booted. Note that the library must either scan or touch all media cartridges when booted.
- Setting the mailbox for import/export commands or as additional storage.

Path: **Main Menu > More > Setup > Utils > Config**

- 1 From the main menu, select **More**. Select **Setup** and then select **Utils**. Select **Config**.

The **Config** dialog box displays.

|                      |        |
|----------------------|--------|
| Scalar 100 DLT       | **     |
| ONLINE               | **     |
| FRI 04/03/99 06:33   | **     |
| Backlight on : Yes   | **     |
| Audio on : No        | **     |
| Scan on Init : No    | **     |
| Touch on Init: Yes   | **     |
| Mailbox: Imprt/Exprt | **     |
| OK                   | Yes/No |
| Next                 | Cancel |

- 2 Using **Yes/No**, **Next**, and **Change**, set the following fields:

- **Backlight on** — Sets the backlight on or off. Possible values are **Yes** or **No**.
- **Audio on** — Determines whether key stroke sounds are made when a button is pressed. Possible values are **Yes** and **No**.
- **Scan on Init** — Indicates whether the library will scan all tape cartridge barcodes when the library is booted up. Note that either **Scan on Init** or **Touch on Init** must be enabled. Possible values are **Yes** or **No**.
- **Touch on Init** — Indicates whether the library picker will touch all tape cartridges when the library is booted up. Note that either **Scan on Init** or **Touch on Init** must be enabled. Possible values are **Yes** or **No**.
- **Mailbox** — Determines whether the mailbox will be used to import and export tape cartridges or if the mailbox will be used as storage slots.
  - **Imprt/Exprt** — Indicates the mailbox is for importing or exporting tape cartridges.
  - **Storage** — Indicates the mailbox is for storage.

- 3 Select **OK**.

## Reading Barcodes of Media in Tape Drives



---

Use **Scan Media** to configure your library so that whenever it takes inventory, the barcode number of all media currently in tape drives is read and stored.

With this command selected, when inventory is taken during power up or when the door is opened, the picker moves any tape cartridges that are in a drive to the first available storage slot and then reads the barcode. If configured to do so, the picker then moves the tape cartridge back to the drive from which it was taken.

Path: **Main Menu > More > Setup > Library > More > Scan Media**

- 1 From the main menu, select **More** and then select **Setup**. Select **Library** and then **Scan Media**.
- 2 In the first field, indicate using **Yes/No** whether or not to scan the barcodes of tape cartridges in drives.

|   |   |        |
|---|---|--------|
|  | <b>Scalar 100 DLT</b>                       |        |
|  | ONLINE<br>FRI 09/12/03 14:35                |        |
|   | Scan media barcode<br>in drives: <b>YES</b> | **     |
|   | Replace media back<br>to drives: No         | **     |
|   |   | **     |
| OK  | Yes/No                                      | Next   |
|   |   | Cancel |

- 3 In the second field, use **Yes/No** to indicate whether or not to place the tape cartridges back into the drives after their barcodes have been scanned.

## Configuring Barcode Length

---

Use **Media** to configure the barcode length (volser) your library reads. The library can read an extended barcode label, 5 to 13 characters. However, you can configure your library to read six character barcode labels.

For more information on barcode labels, refer to [Barcode Label Requirements](#) on page 86.

Path: **Main Menu > More > Setup > Library > Media**

- 1 From the main menu, select **More**. Select **Setup** and then select **Library**. Select **Media**.
- 2 Use **Change** to select one of the following:
  - **DEFAULT** — The library reads 6 character barcode labels.
  - **EXTENDED** — The library reads 5 to 13 character barcode labels.
- 3 Select **OK**.

# Setting Drive SCSI IDs

Use **Drive** to set drive SCSI IDs. The drive SCSI IDs must be different from other SCSI devices on the SCSI bus. Available SCSI IDs are 0 to 15.

Path: **Main Menu > More > Setup > Drive > SCSI**

- 1 From the main menu, select **More**. Select **Setup** and then select **Drive**. Select **SCSI**.
- 2 Use **Change Drive** to select the drive whose SCSI ID you want to set.

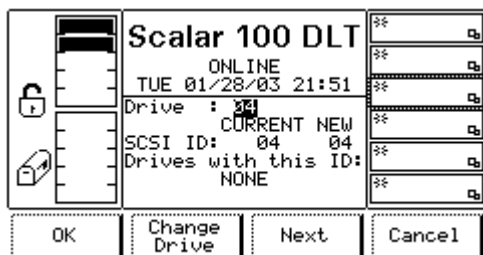

- 3 Select **Next**.
- 4 Use **Up** and **Down** to pick the new SCSI ID for that drive.  
The CURRENT column displays the current SCSI ID. The NEW column displays the new SCSI ID.
- 5 Select **Next**.
- 6 After the dialog box refreshes, the **Drives with this ID** shows how many other drives use the selected SCSI ID. If it displays NONE, select **OK**. Otherwise, change the drive SCSI ID so that it is unique.  
The library resets the SCSI IDs of the affected drives.
- 7 When complete, select **OK**.

## Setting Drive Loop IDs

---

Use **Drive** to set drive Loop IDs. Available Loop IDs are 0 to 15.

Path: **Main Menu > More > Setup > Drive > FC**

- 1 From the main menu, select **More**. Select **Setup** and then select **Drive**. Select **FC**.
- 2 Use **Change Drive** to select the drive whose Loop ID you want to set.
- 3 Select **Next** twice.
- 4 Use **Up** and **Down** to pick the new Loop ID for that drive.

The **CURRENT** column displays the current Loop ID. The **NEW** column displays the new Loop ID. The control path associated with the drive appears in the **Control Path** column.

- 5 Select **Next** twice.
- 6 After the dialog box refreshes, the **Drives with this ID** shows how many other drives use the selected Loop ID. If it displays **NONE**, select **OK**. Otherwise, change the drive Loop ID so that it is unique.

The library resets the Loop IDs of the affected drives.

- 7 When complete, select **OK**.

## Setting the Date and Time

---

Use **Date/Time** to set the library date and time used by the library logs and displayed on the operator panel.

Note that this does not affect the date and time used by the Remote Management Unit (RMU), but does affect the date and time shown in the logs retrieved by the RMU.

Path: **Main Menu > More > Setup > Utils > Date/Time**

- 1 From the main menu, select **More**. Select **Setup** and then select **Utils**. Select **Date/Time**.

The **Date/Time** dialog box displays.

|            |                       |          |        |
|------------|-----------------------|----------|--------|
| Lock icon  | <b>Scalar 100 DLT</b> |          | **     |
|            | ONLINE                |          | **     |
| Drive icon | FRI 04/03/99 06:51    |          | **     |
|            | Set the new values.   |          | **     |
|            | DATE                  | TIME     | **     |
|            | Year : 99             | Hour: 06 | **     |
|            | Month: 04             | Min : 51 | **     |
|            | Day : 03              | Sec : 23 | **     |
| Up         | Down                  | Next     | Cancel |

- 2 Do one of the following:
  - Use **Up**, **Down**, and **Next** to set the values in the **DATE** and **TIME** columns. Note that the library uses a 24 hour clock:
    - **Year**: The last two digits of the year.
    - **Month**: The month number.
    - **Day**: The day.
    - **Hour**: The hour. Note that the library uses a 24-hour clock.
    - **Min**: The number of minutes past the hour.



- **Sec:** The number of seconds.

3 Press **OK**.

## Password Protecting the Operator Panel

---

You can set a password to protect the operator panel. Use the following procedure to enable or disable the password and to set/change the password.

Path: **Main Menu > More > Setup > Utils > Secure**

- 1 From the main menu, select **More**. Select **Setup** and then select **Utils**. Select **Secure**.
- 2 Do one of the following:
  - If you are enabling or disabling security:
    - a. Use **Yes/No** to indicate whether or not you want to enable a password. A checked box means that the password feature is enabled. Selecting **Yes/No** displays a confirmation screen, showing security as **ON** or **OFF**.

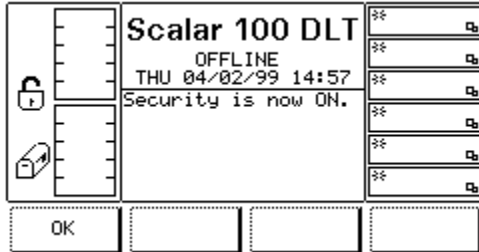

- b. Select **OK**.
- To set or change the password:
    - a. Press **Next** to select **Set/Change Password**. Press **Change**.
    - b. Use **Up** and **Next** to set your four-digit, numeric password. Values are 0 to 9.
    - c. A confirmation dialog box displays. Select **OK**. On the **Secure** menu, select **OK** again.

 **Note** If you are not able to unlock the library, contact ATAC for a master password.

## Locking/Unlocking the Mailbox

---

Use **Sensors** to lock and unlock the mailbox. This lock feature can be useful if you want to restrict access to the library. This command is often used with an operator panel password activated.

Path: **Main Menu > More > Service > Library > Diags > Sensors**

- 1 From the main menu, select **More**. Select **Service** and then select **Library**. Select **Diags** and then **Sensors**.

The sensor information appears. For information on this dialog box, refer to [Getting Sensor Information](#) on page 49.

- 2 Select **Lock/Unlock** to lock and unlock the mailbox. When you are done, select **Cancel**.



# 9

## Maintaining your Library

---

Actions such as exercising the picker, the barcode scanner, and the library itself are considered maintenance. These actions also include performing maintenance on drives and updating firmware.

Most of these actions are reserved for support personnel.

### Displaying SACs (Advanced vs Normal Service)

---

When administering the library, there are certain commands that are password protected and only available for support personnel. These commands are available by selecting **ADVANCED** from the **Service** menu. If you choose **NORMAL**, the Service Action Codes (SACs) are displayed.

Path: **Main Menu > More > Service > Library > Firmware Update**

- 1 From the main menu, select **More**. Select **Service** and then select **Library**. Select **Firmware Update**.
- 2 Using **Normal/Advanced**, select **NORMAL** or **ADVANCED** service.
- 3 Select **OK**.
- 4 If you selected **NORMAL**, the SACs appear. If you selected **ADVANCED**, you are now ready to do advanced service to the library.

### Updating Firmware

---

Periodically, you will need to update your library and drive firmware.

#### Preferred Methods

Although some of these procedures are documented here, typically the operator panel options to update firmware are for use by support personnel. To update your library, drive (LTO only), and/or RMU firmware, use the Remote Management Unit. Firmware may also be updated using the serial port. To get instructions, to update firmware via the serial port, go to [www.adic.com/firmware](http://www.adic.com/firmware).

#### Updating Library Firmware

**Firmware Update** is used by service personnel to update library firmware.

Path: **Main Menu > More > Service > Library > Firmware Update**

Alternatively, you can update firmware with the RMU.

## Updating Drive Firmware

One way to update drive firmware is to use the **Firmware Update** command. This method requires a Firmware Upgrade Tape (FUP tape). To get a FUP tape, contact ATAC.

Path: **Main Menu > Command > Drives > Firmware Update**

- If you have an LTO library, you may be able to create your own FUP tape, refer to [Creating or Erasing a FUP Tape](#) on page 76.
- Alternatively, you can update firmware with the RMU.

1 From the main menu, select **Command** and then select **Drives**. Select **Firmware Update**.

2 Check to make sure the FUP tape is write-protected.

3 Place the FUP tape into slot 1A1 (the top mailbox slot). Select **OK**.

The library performs a TEACH and INVENTORY. The available drives and firmware levels for each drive are displayed.

4 Select the drive(s) you want to update using **Change Drive** and **Unselect**. (All drives are automatically selected, you must unselect the drives that you do not want to update).

Drives that will be updated are indicated with a checkmark.

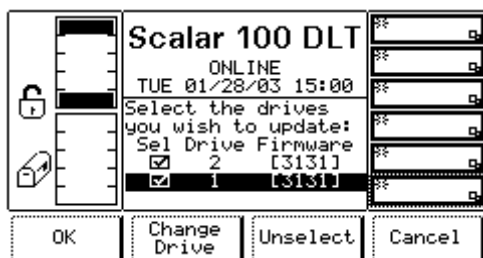

5 Select **OK**.

The picker gets the FUP tape and puts it in the first selected drive. After that drive is updated, the picker places it into the next drive until all selected drives are updated.



**Note**

Once an update has started on a drive, that operation cannot be canceled. Selecting **Cancel** cancels the update for the next drive.

When complete, the picker puts the FUP tape back into slot 1A1.

6 When finished, select **OK**.

## Creating or Erasing a FUP Tape

If you have an LTO library, you can create or erase Firmware Upgrade (FUP) tapes.

Path: **Main Menu > More > Service > Drives > FMR Tape**

1 From the main menu, select **More**. Select **Service** and then select **Drives**.

2 In the **Drive** field, specify the drive whose firmware you want to copy by selecting **Change Drive** until the desired drive appears.

3 Select **FMR Tape**.

- Use **Change** to select **Create** or **Erase**. Select **OK**.



**Note**

You must erase the content of a FUP tape before creating a new FUP tape on the same tape cartridge. If you do not, you will receive errors. Also, if you try to erase a FUP tape whose content is already erased, you will receive errors.

- Open the mailbox and put a scratch tape<sup>1</sup> in the top slot.  
The tape cartridge will be returned to this slot when the command is complete.
- Close the mailbox.  
The library executes a TEACH and INVENTORY command.
- Select **OK**. When complete, a confirmation screen displays. Select **OK**.

## Exercising the Picker Fingers

Use **Fingers** to exercise the picker fingers. This command is a collection of routines that manipulate the open/close and reach/retract operations of the picker fingers.

Path: **Main Menu > More > Service > Library > Diags > Fingers**

The following exercises are available through the **Fingers** menu:

- Getting and putting tape cartridges into storage slots or drives.
- Opening and closing and extending and retracting the fingers.



## Getting and Putting Tape Cartridges

Use **Get/Put** to instruct the library to get a collection of tape cartridges and move them to a different location.

Path: **Main Menu > More > Service > Library > Diags > Fingers > Get/Put**

- From the main menu, select **More** and then select **Service**. Select **Library** and then select **Diags**. Select **Fingers** and then select **Get/Put**.

The **Get/Put** dialog box appears.

|  |                      |      |        |
|--|----------------------|------|--------|
| <br> | Scalar 100 DLT       | **   |        |
|  | OFFLINE              | **   |        |
|  | FRI 04/03/99 16:20   | **   |        |
|  | This test will Get   | **   |        |
|  | and Put all media.   | **   |        |
|  | Cycles to run : 0001 | **   |        |
|  | Number of slots: 000 | **   |        |
| Starting slot : 000  | **                   |      |        |
| New start slot : No  | **                   |      |        |
| Up   | Down                 | Next | Cancel |

- Use **Up**, **Down**, **Next**, and **Yes/No** to specify the following:
  - Cycles to run** — the number of cycles to run. Possible values are 0 to 9999.
  - Number of slots** — the number of slots to use in the cycles.

1. A scratch tape is a blank tape cartridge or a tape whose data can be overwritten.

- For AIT libraries, the possible values are 0 to 96.
- For DLT/SDLT libraries, the possible values are 0 to 60.
- For LTO libraries, the possible values are 0 to 72.
- **Starting slot** — indicates the starting slot. This field is read-only and only changes when **New start slot** is selected.
- **New start slot** — indicates whether you want to change the start slot or use the currently indicated slot. Possible values are **Yes** and **No**.

3 Select **OK**.

4 With **New start slot** selected, press **OK**.

5 If you did not choose to modify the start slot, the exercise runs. If you chose to select a new start slot, do the following:

- With **Select Column** selected, press **Change Column** until the arrow points to the start column. Press **Next**.

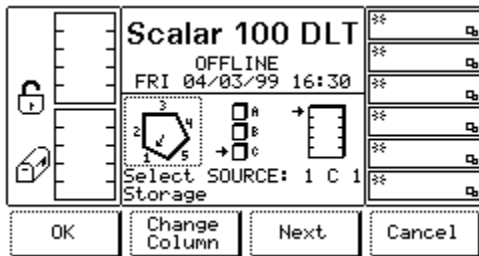

- With **Magazine** selected, select **Change Magazine** until the arrow points to the start magazine. Press **Next**.

- With **Slot** selected, press **Change Slot** until the arrow points to the start slot.

The **Select SOURCE** line displays the start slot. For example, the display below has slot 2A4 selected as the source slot.

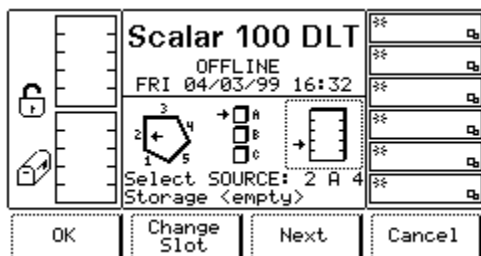

- Select **OK**. The exercise is run.

6 When the exercise is complete, a report displays.

## Opening/Closing and Extending/Retracting

Use **Step** to manipulate the open/close and reach/retract features of the picker fingers.

Path: **Main Menu > More > Service > Library > Diags > Fingers > Step**

- 1 From the main menu, select **More** and then select **Service**. Select **Library** and then select **Diags**. Select **Fingers** and then select **Step**.

A dialog box appears warning that only qualified personnel should operate this feature.

- 2 Select **OK**.

- 3 Use **Open/Close** to open and close the picker fingers. Use **Extend/Retract** to extend and retract the picker fingers.

The actions are performed in real time and the screen updates to reflect the current action.

- 4 When finished, select **Cancel**.

## Exercising the Barcode Scanner

---

Use **Scanner** to instruct the barcode scanner to read the barcode information on the media cartridge in front of it. Use this command in conjunction with [Moving the Picker](#) on page 61.

Path: **Main Menu > More > Service > Library > Diags > Fingers > Scanner**

- 1 From the main menu, select **More** and then select **Service**. Select **Library** and then select **Diags**. Select **Fingers** and then select **Scanner**.

- 2 Select **Scan**.

The barcode is read and the resulting barcode number appears at the bottom of the dialog box. If there is no tape cartridge in the slot or if the label is bad or missing, **BAD READ** appears.

## Exercising the Picker Axes

---

Use **Picker** to manipulate the vertical and rotary axes of the library picker. You can exercise both dimensions at once or a single dimension.

Path: **Main Menu > More > Service > Library > Diags > Picker**

## Moving the Picker in a Motion Pattern

Use **Move** to cycle the vertical and rotary axes of the picker in a motion pattern.

Path: **Main Menu > More > Service > Library > Diags > Picker > Move**

- 1 From the main menu, select **More** and then select **Service**. Select **Library** and then select **Diags**. Select **Picker** and then select **Move**.

- 2 Using **Up**, **Down**, and **Next**, complete the following fields:

- **Cycles to run** — specifies the number of move cycles. Possible values are 0 to 9999.
- **Use vertical** — specifies whether or not to exercise the vertical axis during this test. Possible values are **Yes** and **No**.
- **Use horizontal** — specifies whether or not to exercise the horizontal axis during this test. Possible values are **Yes** and **No**.

- 3 With **Use vertical** or **Use horizontal** selected, press **OK**.

- 4 While the exercise is running, the status appears on the operator panel.

## Moving the Picker in Increments

Use **Step** to manipulate the vertical and rotary axes of the picker in incremental steps.



### Note

This is an advanced diagnostic tool that is not intended for use during normal operation.

Path: **Main Menu > More > Service > Library > Diags > Picker > Step**

- 1 From the main menu, select **More** and then select **Service**. Select **Library** and then select **Diags**. Select **Picker** and then select **Step**.
- 2 A dialog box appears warning that only qualified personnel should operate this feature. Select **OK**.
- 3 Using **Up**, **Down**, and **Next**, complete the following fields. The picker moves as you press these buttons.
  - **Pivot axis** — specifies the number degrees the picker will rotate. Possible values are 0 to 275 degrees.
  - **Vert. axis** — specifies how many millimeters the picker will be extended during this exercise. Possible values are 0 to the maximum height for your library.
  - **Step amount** — specifies how many tenths of millimeters the picker should step. Possible values are 1 to 100.

## Sending the Picker to the Home Position

Use **Home** to send the vertical and rotary axes to their home positions.

Path: **Main Menu > More > Service > Library > Diags > Picker > Home**

- 1 From the main menu, select **More** and then select **Service**. Select **Library** and then select **Diags**. Select **Picker** and then select **Home**.
- 2 Select **OK**.

## Exercising the Library

---

Use **Exercise** to access library exercises. You can run a demonstration, self test, or teach operations. These exercises are helpful when troubleshooting and when testing new configurations.

## Running a Demo

Use **Demo** to run a demonstration routine. This command is helpful for testing new library configurations to ensure all the components are interacting correctly.



### CAUTION

**This command could potentially move a cartridge into an incorrect partition, if the library has been partitioned by the host.**



### Note

Demo Test randomly moves tapes within the library to demonstrate robotic motion. The Demo Test requires one more tape than the number of drives in the library. For example, if your library has one drive, there must be at least two pieces of media in it for Demo Test to complete successfully.



Path: **Main Menu > More > Service > Library > Exercise > Demo**

- 1 From the main menu, select **More**. Select **Service** and then select **Library**. Select **Exercise** and then **Demo**.
- 2 Use **Up**, **Down**, **Next**, **Change**, and **Yes/No** to complete the following fields:
  - **Partition** — specifies running the demonstration on a specific partition (Partition 1, 2, or 3) or on the entire library (All). Possible values are 1, 2, 3, or All.
  - **Demo Mode** — specifies the type of demonstration to run. Possible values are Cycle or Time.
    - **Cycle** — specifies running the demonstration based on the number of completed cycles.
    - **Time** — specifies running the demonstration based on time elapsed.
  - **Cycles to run** — specifies the number of cycles the demonstration will be run. This option is only available if **Cycle** was specified. Possible values are between 0 and 9999.
  - **Hours to run** — specifies the number of hours to run the demonstration. This option is only available if **Time** was specified. Possible values are 2 hour increments up to 24 hours.
  - **Include Drives** — specifies whether or not to include drives in the demonstration.



**Note** The demonstration mode does not read/write to drives. The demonstration mode only loads and unloads cartridges within the library.

- **Mailbox** — specifies whether or not to include the mailbox in the demonstration.
- 3 Select **OK**.

The demonstration runs. A status menu appears during the demonstration.
  - 4 When complete, select **OK**.

## Running a Self Test

Use **Self Test** to run a series of pre-programmed tests that exercise the integrity of the system.

Path: **Main Menu > More > Service > Library > Exercise > Self Test**

- 1 From the main menu, select **More**. Select **Service** and then select **Library**. Select **Exercise** and then **Self Test**.
- 2 Use **Up**, **Down**, **Next**, and **Yes/No** to complete the following fields:
  - **Cycles to run** — specifies the number of times to run the Self Test.
  - **Include drives** — specifies whether or not to include the drives.
- 3 Select **OK**.

The test runs. A status menu appears during the test.
- 4 When complete, select **OK**.

## Teaching the Library

This feature instructs the library to determine what resources exist in the library, including how many drives, columns, and magazines.

Path: **Main Menu > More > Service > Library > Exercise > Teach**

- 1 From the main menu, select **More**. Select **Service** and then select **Library**. Select **Exercise** and then **Teach**.

- 2 Select **OK**.  
The library is calibrated.
- 3 When complete, select **OK**.

## Resetting a Drive

---

Use the **Reset** command if you want to reset a drive and not interfere with other library functions. There are two reset options: soft resets and hard resets. A soft reset is used in instances where you want restart a drive, for example if you want to invoke a new Loop or SCSI ID. Hard resets are used when there are drive errors.

Path: **Main Menu > Command > Drives > Reset**

- 1 From the main menu, select **Command** and then select **Drives**. Select **Reset**.
- 2 Using **Change**, select the drive to be reset or select **ALL** to reset all the drives. Select **Next**.
- 3 Using **Change**, select the type of reset: soft or hard.

A soft reset runs the drive's power-on self test. A hard reset first turns off then restarts the drive. In most cases, a soft reset is preferable to a hard reset.

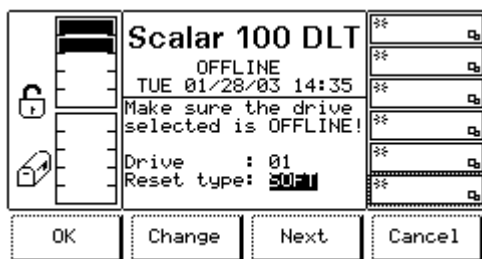

- 4 Select **OK**.

## Servicing Drives

---

Use **Drives** when performing maintenance on drives. Only LTO drives can be serviced. This menu allows you to:

- Discontinue or reinitialize communication with a drive (this is necessary when replacing a drive).
- Run diagnostic tests on your drive (for use by service personnel).

## Preparing a Drive

Before you prepare a drive, the host may have to be disconnected. For more information on preparing your host, refer to [Preparing the Host](#) on page 18. Use **Repair** when you are replacing a drive. **Repair** informs the library that the drive is going to be removed from the library. There is no communication with the drive until it is replaced.

Path: **Main Menu > More > Service > Drives > (select drive) > Repair**

- 1 From the main menu, select **More**. Select **Service** and then select **Drives**.
- 2 Specify the drive you want to replace in the **Drive** field. Select **Change Drive** until the desired drive is selected.

- 3 Select **Repair**.
- 4 Using Change, specify **Remove** or **Replace**. Select **OK**.
- 5 If you selected **Remove**, you can now remove the drive. If you selected **Replace**, communication with the drive is initialized.

## Running Drive Diagnostic Tests

Before contacting ATAC, run the appropriate drive diagnostic tests. A collection of drive tests are available for LTO libraries. The drive diagnostic tests are available through the path indicated below; however, they are reserved for use by support personnel.

- FAST Read/Write — executes a load and unload, and a read and write test.
- NORMAL Read/Write — executes a load and unload, and a read and write test.
- Media Read/Write — executes a test to ensure that a suspect cartridge and its magnetic tape are acceptable.
- Head Read/Write — executes a test to ensure that the drive's head and tape-carriage mechanics are working properly.
- Power On Self Test — executes the drive power on self-test.



**Note** Do not use WORM (write once, read many) media when performing this test. The diagnostic tests will not work with WORM media.

Path: **Main Menu > More > Service > Drives > (select drive) > Diags**

- 1 From the main menu, select **More**. Select **Service** and then select **Drives**. Select **Diags**.
- 2 Select the appropriate dialog you wish to run.
- 3 Select **OK**.



# 10

## Working with Tapes and Barcodes

---

When working with tape cartridges, there are certain considerations that should be taken into account. For example, all tape cartridges in the library must have a barcode label. In addition, when loading your library, you should be aware of whether or not your tape cartridges are write-protected.

This section discusses these types of items in general terms. For information about what type of tape cartridges are supported for each drive type, refer to [Specifications](#) on page 111.

### Selecting Approved Media Types

---

To ensure that the library conforms with ADIC requirements for reliability, use only ADIC supplied tape cartridges.

Other certified media may be used, but it may not meet the standards of reliability established by ADIC.

### Write-Protecting Tape Cartridges

---

All tape cartridges have a write-protect switch that prevents data from being accidentally erased or overwritten. Before inserting a tape cartridge into a library, ensure the write-protect switch is in the correct position.

Most media indicate that the tape is write-protected with a orange or red tab. Other indications include an opened or closed lock.

### Tape Use Guidelines

---

For longer life of recorded or unrecorded cartridges, store cartridges in a clean environment under the following conditions:

- Do not drop or bang the cartridge. This can displace the tape leader, making the cartridge unusable and possibly damaging the drive.  
Do not use dropped or damaged cartridges. There may be warranty implications if damaged is caused by using a dropped or damaged cartridge.
- Keep tape cartridges out of direct sunlight and away from heaters and other heat sources.
- Store tape cartridges at temperatures between 50°F to 104°F (10°C to 40°C). For longer cartridge life, always store the cartridge in its plastic container and in room environment conditions of 72°F (±7°F) (22°C [±4°C]).

- If the tape cartridge is exposed to heat or cold extremes, stabilize the cartridge at room temperature for the same amount of time it was exposed—up to 24 hours.
- Do not place a cartridge near electromagnetic interference sources, such as terminals, motors, and video or X-ray equipment. Data on the tape can be altered.
- Store tape cartridges in a dust-free environment where the relative humidity is between 20% and 80%. For longer cartridge life, store the cartridge at 40%,  $\pm 20\%$  relative humidity.
- Do not adhere labels to a cartridge anywhere except in the area on the front of the cartridge or the slide-in slot.

## Using Barcode Labels

---

All tape cartridges in the library must have a unique barcode label that is machine readable and identifies the volume serial number.

For information on how to configure the length of barcodes read by the scanner, refer to [Configuring your Library](#) on page 67.



Note

Although it is recommended that cleaning tapes have barcode labels, it is not required.

## Applying Barcode Labels

Barcode labels are applied to the front of the cartridge. Depending on the media type, barcode labels are either stickers that are adhered to the front of the tape cartridge or cutouts that you slide into an indentation on the front of the cartridge.



**CAUTION**

**Be careful not to apply barcode labels upside down.**

## Barcode Label Requirements

A barcode must use only uppercase letters A to Z and/or numeric values 0 to 9. Your library currently supports Code 39 type barcode labels.

In addition, barcode labels must adhere to the following requirements:

- ANSI MH10.8M-1983 Standard
- Number of digits: 5-13 (based on mode)
- Background reflection: greater than 25 percent
- Print contrast: greater than 75 percent
- Ratio: greater than 2.2
- Module: 250 mm
- Print tolerance:  $\pm 57$  mm

Additional Requirements

- Length of the rest zones: 5.25 mm  $\pm$  0.25 mm.

- No black marks should be present in the intermediate spaces or rest zones.
- No white areas should be present on the bars.
- Bars should read in a uniform direction. Nonuniform reading directions are feasible in principle, but have a detrimental effect on performance.
- Quality Testing

You will have the best scanning results if you use ADIC-supplied barcode labels.

If you want to print your own barcode labels, ensure the labels meet the requirements listed here. (You can ensure and document barcode compliance by using the Ergilaser 3000 High Density barcode measuring device, manufactured by the Laetus Company.)

If you want to purchase barcode labels from a supplier other than ADIC, the Scalar 100 supports barcode labels purchased from Engineered Data Products.





# 11

## Using the Remote Management Unit

The Remote Management Unit (RMU) is a component in your library that provides remote access to the library via a Web browser. All functions listed here are available without the need of a dedicated server (or separate software).

The RMU performs the following functions:

- Provides remote operation of all library operator panel functions via a Web browser.
- Allows you to check the status of the system, firmware levels, and other useful information.
- Updates RMU, drive (LTO only), and Library Controller firmware.
- Supports Simple Network Management Protocol (SNMP) and acts as a SNMP-server, generating SNMP traps and responding to SNMP requests.
- Supports ADIC Library Management Information Base (MIB) version 2.0.
- Detects a power loss and generates an SNMP trap for notification.
- Enables the retrieval of library logs and library, drive, and RMU diagnostic files.
- Allows RMU configuration changes such as network, users, and date/time changes.

**Figure 17** The Remote Management Unit

| Status  | Configuration            | Firmware | Diagnostics file | Operator panel | Logs |
|---|--------------------------|----------|------------------|----------------|------|
| <b>ADIC Scalar 100 DLT</b>  |                          |          |                  |                |      |
|  |                          |          |                  |                |      |
| <b>Library Status</b>   |                          |          |                  |                |      |
| Drive Status  | DLT: 6 drives            |          |                  |                |      |
| RMU User  | admin from 172.16.34.227 |          |                  |                |      |
| Hostname  | Fred                     |          |                  |                |      |
| IP Address  | 172.16.38.43             |          |                  |                |      |
| MAC Address   | 00:30:8C:01:19:4A        |          |                  |                |      |
| Library Serial #  | ADIC111111111111         |          |                  |                |      |
| SNMP Alerts   | SNMP Off                 |          |                  |                |      |
| Library Firmware  | 2.90.0005                |          |                  |                |      |
| RMU Firmware  | 140A.00016               |          |                  |                |      |

# Supported Browsers

---

The RMU supports the following browsers:

- Microsoft Internet Explorer version 5.0 and above
- Netscape Navigator versions 4.01 for Unix and 4.7X for all other environments



Note

In certain versions of Netscape, the operator panel may not appear correctly.

## RMU Requirements

---

The RMU requires a network address that consists of an Internet Protocol (IP) address, subnet mask, and gateway IP Address.

Once these are established, input this information to the RMU via the operator panel. For more information, refer to the discussion that follows.

## Setting up the RMU

---

Once you have established a network address for the RMU, input this information to the RMU via the operator panel.

Path: **Main Menu > More > Setup > Library > RMU**

- 1 From the main menu, select **More**. Select **Setup** and then select **Library**. Select **RMU**.
- 2 Using the **Up**, **Down**, and **Next** buttons, enter the IP address, subnet mask, gateway IP address, and host name.
- 3 When complete, press **Next** until you reach the end of the **Name** field. Select **OK**.

The screenshot shows a terminal-style interface for the RMU. The title is "Scalar 100 DLT". The status is "ONLINE" and the date/time is "THU 04/17/03 08:34". The network configuration is as follows:

|      |               |
|------|---------------|
| IP   | :172.16.38.43 |
| Sub  | :55.255.248.0 |
| Gate | :172.16.32.2  |
| Name | :Fred         |

At the bottom, there are four buttons: "OK", "Next", and "Cancel".

# Starting the RMU

---

Before you begin using the RMU, make certain you have configured your RMU with the correct network address.

- 1 Open a Web browser.
- 2 Enter the RMU IP address in your browser, excluding any leading zeros.

For example if your IP address is 182.073.056.205 on the operator panel, go to the following address:  
`http://182.73.56.205`

The RMU user interface displays.

# Logging into the RMU

---

Some of the features of the RMU require you to log in.



**Note** The default login and password are *admin* and *secure*, respectively.

- When prompted, enter your login name and password.



**Note** The login name and password are case sensitive.

# Checking Status and General Information

---

You can use the RMU to remotely check the status of a library and obtain general information about the library. For example, you can check drive status or get the firmware level of your library.

- 1 Click the **Status** tab.

The following information appears:

- **Library Status** — indicates whether the library is online or offline.
- **Drive Status** — indicates the type and quantity of tape drives in the library.
- **RMU User** — indicates the name and location of the user.
- **Hostname** — indicates the hostname used for the RMU connection.
- **IP Address** — indicates the IP address for the RMU connection.
- **MAC Address** — indicates the Media Access Control (MAC) address of the RMU. This is also the serial number of the RMU.
- **Library Serial #** — indicates the library serial number.
- **SNMP** — indicates whether the SNMP feature is on or off.
- **SNMP Alerts** — indicates whether the SNMP Alert notification feature is on or off.
- **Library Firmware** — indicates the current level of library firmware.
- **RMU Firmware** — indicates the current level of RMU firmware.

## Configuring Network Parameters

---

You can reconfigure the hostname, IP address, subnet mask, and gateway address through the RMU. This feature requires you to login to the RMU. Refer to [Logging into the RMU](#) on page 91 for more information.

- 1 Click the **Configuration** tab.
- 2 In the **Network Configuration** area, enter the new hostname, IP address, subnet mask, and gateway address.
- 3 Click **Submit** and review your changes (indicated in red).
- 4 Enter your password and click **Confirm** to complete the procedure.

The new values are saved. Note that you may need to redirect your Web browser.

## Configuring SNMP

---

Simple Network Management Protocol (SNMP) is a set of protocols used to manage nodes on an IP network. You can configure the RMU to run a SNMP management application.

- 1 Click the **Configuration** tab.
- 2 In the **SNMP Configuration** area, do the following:
  - To enable or disable the feature, select **ON** or **OFF** in the **SNMP Enabled** drop-down.
  - To enable or disable SNMP alerts, select **ON** or **OFF** in the **Alerts Enabled** drop-down.
  - In **Manager**, enter the SNMP server address.
  - In **Public Name**, enter the name of the read-only SNMP community.
  - In **Private Name**, enter the name of the read/write SNMP community.
- 3 Click **Submit** and review your changes (indicated in red).
- 4 Enter your password and click **Confirm** to complete the procedure.

The new values are saved. Note that you may need to redirect your Web browser.

- 5 You will be instructed to reboot the RMU. Click **Done** to reboot.

## Downloading the SNMP MIB File

The SNMP Management Information Base (MIB) file will allow an SNMP management application to understand the SNMP traps generated by the RMU. If you are running an SNMP management application and need the library MIB, you can download it via the RMU.

- 1 Click **SNMP MIB** in the left pane of the RMU interface.
- 2 Right-click **Download SNMP MIB** and click **Save Target As**.
- 3 Browse to your SNMP management server and click **Save**.

You will need to load the MIB file into the SNMP management application.

## Configuring RMU User Accounts

---

You can add unique users to the RMU. Only one administrator account is allowed, which maintains the login of *admin*.

## Adding/Removing Users

Only the admin account can add or remove users.

- 1 Click the **Configuration** tab.
- 2 In the **User Configuration** area, do one of the following:
  - If you are adding a user:
    - a. In the **Management Action** drop-down, click **Create User**.
    - b. In **Edit New**, enter the user name.
    - c. In **Password**, enter the login password and then confirm it in **Re-enter Password**.
  - If you are deleting a user:
    - a. In the **Management Action** drop-down, click **Delete User**.
    - b. In **Select One**, select the user you want to remove.
- 3 Click **Submit** and review your changes (indicated in red).
- 4 Enter your password and click **Confirm** to complete the procedure.

## Changing a Password

At any time, you can change your RMU password. If you are the admin, you can change users' passwords.

- 1 Click the **Configuration** tab.
- 2 In the **User Configuration** area, select **Change User Password** from the **Management Action** drop-down.
- 3 If not already selected, select the appropriate user account from the **Select One** drop-down.



**Note** Only the admin can modify another user's password.

- 4 Click **Submit** and review your changes (indicated in red).
- 5 Enter your password and click **Confirm** to complete the procedure.

## Configuring the Time and Date

---

You can configure the date and time for the RMU. The date and time will be used in the RMU log file to report when events occurred.

- 1 Click the **Configuration** tab.
- 2 Enter the date and time in the **Date and Time** area.
- 3 Click **Submit** and review your changes (indicated in red).
- 4 Enter your password and click **Confirm** to complete the procedure.

# Updating Firmware

---

You can update firmware for the RMU, library, and drives (LTO only). Before you update firmware, you need to have the firmware file in a location that is accessible from the RMU interface. Firmware updates can be found on [www.adic.com](http://www.adic.com).

- 1 Click the **Firmware** tab.
- 2 Select the firmware you would like to update.



Note

Only LTO drive firmware can be updated with the RMU.

- 3 Click **Browse** and browse to the location of the firmware update file.



Note

Downloading firmware can take several minutes. For details on how long it will take to download firmware, click **some time** above the **Update Firmware** button.

- 4 Click **Update Firmware**.

The firmware will be updated. If the library was selected for a firmware update, it will automatically reboot when the update is complete. If the RMU was selected, you will be prompted for a reboot when the update is complete.

# Viewing Diagnostic Files

---

From the RMU, you can view the diagnostic information for the attached library and RMU. This information can assist technical support personnel when diagnosing problems.

- 1 Click the **Diagnostics file** tab.
- 2 Select the file you would like to view. The available options are:
  - **Library Command Log**—Provides command logs for the library.
  - **Library Error Log**—Provides error logs for the library.
  - **RMU Support Log**—Provides support logs for the RMU.
  - **RMU Error Log**—Provides error logs for the RMU.
  - **Drive x Error Log**—Provides drive error logs.
  - **Drive x Dump**—Provides drive diagnostic dump information.
  - **Version**—Provides firmware version of library, drives, and RMU.
  - **Show Position**—Provides library “shpos” information (learned offsets for cells, etc.)
- 3 Click **Retrieve selected file**.

The file will be loaded.
- 4 Click **Display File** to view the file in a separate browser window.

## Using the Operator Panel (via the RMU)

---

The RMU provides access to the library via a virtual operator panel.

- Click the **operator panel** tab.

A graphical representation of the operator panel appears. You can click the softkeys and control the library the same way that you would from the front of the library. For more information on the operator panel, refer to [Using the Operator Panel](#) on page 37.

## Viewing Logs

---

You can view the most current entries in the library command log without having to download the entire log file.

- Click the **Logs** tab.

The command log appears with the most recent entry at the top of the list.

## Getting Help

---

The RMU provides access to help for the following items:

- **Contents**—Provides a description of each of the tabs on the RMU interface.
- **Documentation**—Provides a link to the user documentation for the library.
- **SNMP MIB**—Provides information on the SNMP MIB file. For more information, refer to [Configuring SNMP](#) on page 92.
- **Support**—Provides information on contacting technical support.
- **Version**—Provides the current revision level of the RMU firmware.

To get help, click the item in the left pane of the RMU interface. The information appears in a separate browser window.

## Replacing the RMU

---

Tools required: None.



### Note

This FRU contains firmware, verify the replacement FRU has the latest firmware installed. Upgrade the firmware if necessary.

- 1 Power off the library by setting the AC Input Power Module main switch to the **Off** position.
- 2 Disconnect the network cable from the RMU.
- 3 Loosen the thumbscrew on the RMU then slide the unit out of the Scalar 100 chassis.
- 4 Install replacement RMU and reverse the process noted in steps 1 through 3.





# 12

## Troubleshooting and Help

When a failure occurs, the Scalar 100 firmware performs error recovery and reporting. Error reporting includes Service Action Codes (SACs), operator intervention messages, and operator information messages. All of these messages are discussed and explained here.

### Service Action Codes

If a failure requires operator service, a two-byte Service Action Code (SACs) is generated and displayed on the operator panel. These codes indicate a specific task that should be taken. [Table 8](#) lists each SAC and the recommended actions.

The two-byte SAC definition is generated as follows:

- **nn** represents the Service Action Code
- **xx** represents the modifier to the Service Action Code
  - **00** represents the main controller
  - **10** represents the picker controller
  - **20** represents the display assembly
  - **3x** represents the drive module
    - **x** represents the drive ID
  - **40** represents SCSI controller
  - **50** represents Remote Management Unit (RMU)

**Table 8** Service Action Code Descriptions

| Reported SAC | Error and Solution  |
|--------------|---|
| 01 xx        | <b>Type 1 software errors including microcode and operating system errors. Error also due to communication time-out with the drive.</b>                           |
|              | Power off and on the Scalar 100 library to recover from the error. Use the rear switch to perform this action, wait at least one minute between power off and on. |

**Table 8** Service Action Code Descriptions

| Reported SAC | Error and Solution  |
|--------------|---|
| 02 xx        | <b>Type 2 Software errors including microcode logic and operating system errors.</b>  |
|              | Power off and on the Scalar 100 library to recover from the error. Use the rear switch to perform this action, wait at least one minute between power off and on. |
| 03 xx        | <b>Type 3 Software errors including microcode logic and operating system errors.</b>  |
|              | Power off and on the Scalar 100 library to recover from the error. Use the rear switch to perform this action, wait at least one minute between power off and on. |
| 04 xx        | <b>Type 4 Software errors (inter processor) including microcode and operating system errors.</b>  |
|              | Power off and on the Scalar 100 library to recover from the error. Use the rear switch to perform this action, wait at least one minute between power off and on. |
| 05 xx        | <b>A permanent operating system error occurred.</b>   |
|              | Power off and on the Scalar 100 library to recover from the error. Use the rear switch to perform this action, wait at least one minute between power off and on. |
|              | Contact ATAC.   |
| 10 xx        | <b>Barcode scanner communications failed.</b>   |
|              | Retry the failing operation.  |
|              | Power off and on the Scalar 100 library to recover from the error. Use the rear switch to perform this action, wait at least one minute between power off and on. |
|              | Contact ATAC.   |
| 11 xx        | <b>Barcode scanner communication is OK, data received from the barcode scanner is bad.</b>  |
|              | Ensure that the barcode label was supplied by ADIC or an ADIC approved vendor.  |
|              | Contact ATAC.   |

**Table 8** Service Action Code Descriptions

| Reported SAC   | Error and Solution  |
|--|---|
| 13 xx  | <b>Cannot read barcode label or the label is bad.</b>   |
|  | Ensure that the barcode label was supplied by ADIC or an ADIC approved vendor.  |
|  | Check the cartridge labels to ensure that they meet specifications, are properly installed, and not damaged or dirty. The cartridge slots in question are displayed with the Service Action Code.   |
|  | Ensure that scan beam is not obstructed.  |
|  | Retry the failing operation.  |
|  | Power off and on the Scalar 100 library to recover from the error. Use the rear switch to perform this action, wait at least one minute between power off and on.   |
|  | Contact ATAC.   |
| 14 xx  | <b>The system detects that the serial number is missing from its NVRAM.</b>   |
|  | Locate the sytem serial number and write it down. Enter the system serial number (Using serial cable and HyperTerminal). Enter “setser” command from the HyperTerminal prompt.  |
|  | Contact ATAC.   |
| 15 xx  | <b>An intermittent scanning error was detected. During demo, the library performs inventory after each complete demo cycle and detects a mismatch between the number of cartridges scanned and its previous database.</b>   |
|  | Note the number of cartridges installed in the library and use the operator panel to compare this information with the number of cartridges reported by the library. Examine the cartridges that are installed but not reported by the library for proper cartridge labels, replace the labels if necessary. Note that if a whole column of cartridges is missing, the column fiducial label can be defective, in this case the whole storage column must be replaced.<br><br>If all labels are correct, clear the SAC and retry the demo program (at least five cycles). |
|  | Contact ATAC.   |
|  | 21 xx   |
| Check the library configuration and re-enter all data (SCSI ID, time/date, library serial number, etc.). For instructions on how to do this, refer to <a href="#">Configuring your Library</a> on page 67. |   |
| Power off and on the Scalar 100 library a few times and see if the same error conditions re-appear. Use the rear switch to perform this action, wait at least one minute between power off and on.         |   |
| Contact ATAC.  |   |

**Table 8** Service Action Code Descriptions

| Reported SAC | Error and Solution   |
|--------------|--|
| 38 xx        | <p><b>The Remote Management Unit (RMU) can not communicate with the DHCP server.</b></p> <p>Contact ATAC.</p>  |
| 39 xx        | <p><b>An external network error was detected by the Remote Management Unit (RMU).</b></p> <p>Ensure that the network cable is connected from the DHCP server to the RMU.</p> <p>Ensure that the RMU is configured to operate with the DHCP.</p> <p>Contact ATAC.</p>   |
| 40 xx        | <p><b>The Library detects that Servo power is missing.</b></p> <p>Contact ATAC.</p>  |
| 42 xx        | <p><b>An incorrect library configuration is detected: the mailbox storage column is missing; also error due to drives out of order or multiple drive types installed.</b></p> <p>Check to make sure that the mailbox column is installed and the fiducial label is properly installed and not damaged. The fiducial label is present on both the single slot mailbox and the multi-slot mailbox. Only one drive type is installed in the Library Control Path library with no gaps between drive locations.</p> <p>Contact ATAC.</p> |
| 43 xx        | <p><b>An unknown library configuration is detected, the barcode scanner is unable to read the fiducial label located on the storage column or storage magazine during a Teach operation.</b></p> <p>Ensure that the microcode level in the Scalar 100 supports the hardware installed. Refer to <a href="#">Getting Firmware and Serial Number Information</a> on page 48.</p> <p>Check for a dirty, damaged, missing or wrong fiducial label located at the storage array in the Library.</p> <p>Contact ATAC.</p>                  |
| 44 xx        | <p><b>An unknown fiducial label is detected during a Teach operation.</b></p> <p>Ensure that the microcode level in the Scalar 100 supports the hardware installed. Refer to <a href="#">Getting Firmware and Serial Number Information</a> on page 48.</p> <p>Check for a dirty, damaged, missing or wrong fiducial label where the picker is positioned.</p> <p>Contact ATAC.</p>  |
| 45 xx        | <p><b>Incompatible sled type. Mismatched sled and fiducial type.</b></p> <p>Contact ATAC.</p>  |

**Table 8** Service Action Code Descriptions

| Reported SAC | Error and Solution  |
|--------------|---|
| 46 xx        | <b>The barcode scanner detected a cartridge when one was not expected. This occurs because the magazine's fiducial label was not scanned by the library. Therefore, the library does not recognize the magazine as being installed in the column.</b> |
|              | This error can be caused by a dirty barcode scanner (dust or fingerprints). Verify that the barcode scanner is clean.   |
|              | Check for a dirty, damaged, missing or wrong fiducial label on the magazine containing the cartridge in question.   |
|              | Contact ATAC if the barcode scanner is dusty or has finger prints.  |
| 60 xx        | <b>Cannot complete the lock/unlock mailbox commands.</b>  |
|              | Run lock diagnostics from the operator panel to see if there is any mechanical bindings. Refer to <a href="#">Locking/Unlocking the Mailbox</a> on page 73.   |
|              | Contact ATAC.   |
| 70 xx        | <b>Failures detected in the picker assembly grip finger open operation.</b>   |
|              | Run grip finger diagnostics. Refer to <a href="#">Exercising the Picker Fingers</a> on page 77.   |
|              | Contact ATAC.   |
| 71 xx        | <b>Failures detected in the picker assembly grip finger close operation.</b>  |
|              | Run grip finger diagnostics. Refer to <a href="#">Exercising the Picker Fingers</a> on page 77.   |
|              | Contact ATAC.   |
| 72 xx        | <b>A get command was issued but the sensor indicated that a cartridge is already present in the picker assembly.</b>  |
|              | Look into the picker assembly and see if a cartridge is present. If a cartridge is found in the picker, recover the cartridge and place it in any empty slot, close the door and retry the failing operation.   |
| 73 xx        | <b>Failures detected in the picker assembly grip finger open/close operations.</b>  |
|              | Contact ATAC.   |
| 74 xx        | <b>A get command was issued but the sensor indicated that the source location is empty.</b>   |
|              | This error can be caused by a cartridge that is not fully inserted in the storage slot above the failing slot. If this condition exists, push the cartridge into its slot and close the library door.   |
|              | Contact ATAC.   |
| 77 xx        | <b>Failures detected in the picker assembly during a retract operation.</b>   |
|              | Contact ATAC.   |

**Table 8** Service Action Code Descriptions

| Reported SAC                                 | Error and Solution   |
|--|--|
| 78 xx  | <b>A put command was issued but the sensor indicated that the cartridge is not present in the picker assembly.</b>   |
|  | Contact ATAC.  |
| 7A xx  | <b>Failures detected in the picker assembly reach/retract operations.</b>  |
|  | Check to make sure that the picker assembly Flex cable is properly connected and seated at the picker control PCBA. If not routed properly, this cable can pop out of its connector when the picker flex cable cover is installed.   |
|  | This failure can be the result of drive not ejecting the cartridge properly so the picker can retrieve it. Check the drive for proper cartridge ejection (the cartridge must be easily retrieved without any force), replace the drive if necessary.   |
|  | Contact ATAC.  |
| 7C xx  | <b>Failures detected in the picker assembly reach operation.</b>   |
|  | Check for obstruction in the slot. Obstruction can be in the form of: <ul style="list-style-type: none"> <li>• an unlabeled cartridge</li> <li>• a cartridge in the slot during a put operation.</li> <li>• the slot wall in the magazine is too tight.</li> </ul> Remove the obstruction or replace the magazine, close the door and retry the failing operation. |
|  | Contact ATAC.  |
|  | 7E xx  |
| Check the cartridge for any physical damage. |  |
| Replace the failing drive module.            |  |
| 80 xx  | <b>Failures detected in the rotary-axis servo system.</b>  |
|  | Contact ATAC.  |
| 81 xx  | <b>Failures detected in the Y-axis servo system.</b>   |
|  | Contact ATAC.  |
| 82 xx  | <b>An unexpected motion control condition was received.</b>  |
|  | Contact ATAC.  |
| 83 xx  | <b>The locate fiducial command failed with no target found. This failure happens most likely during an initial installation of the library subsystem.</b>  |
|  | Check and clean all fiducial labels.   |
|  | Contact ATAC.  |

**Table 8** Service Action Code Descriptions

| Reported SAC | Error and Solution  |
|--------------|---|
| 89 xx        | <b>Failure was detected while communicating with the motion controllers.</b>  |
|              | Contact ATAC.   |
| 8A xx        | <b>The returned sense indicated that a motion command completed sooner than expected.</b>   |
|              | Check the Y axis for binding. Binding can be caused by an object that prevents the Y axis from homing and reaching its target correctly.  |
|              | Contact ATAC.   |
| 8B xx        | <b>Servo failures detected in the Rotary and/or Reach axes.</b>   |
|              | Check for obstruction in the drive. Remove any obstruction and reissue the command to put a cartridge in the drive.   |
|              | Contact ATAC.   |
| 93 xx        | <b>A failure was detected in the drive communication hardware within the library: the library cannot communicate with one or more drives (note the physical location of the failing drive, this information is presented with the SAC).</b>   |
|              | If the accompanying message indicated that the library cannot communicate with one specific tape drive, ensure that the tape drive is properly installed in the drive slot.   |
| 94 xx        | <b>Communication was previously established between the Library and the tape drive but the library detected that communication is no longer present or the drive status is not as expected.</b>   |
|              | Ensure that the failing drive module is properly installed and powered on. Check for a cartridge in the failing tape drive that prevents the drive from becoming ready. If a cartridge is present, eject the cartridge and retry the operation. If the operation continues to fail, replace the drive module. |
|              | Contact ATAC.   |
| 95 xx        | <b>The picker assembly delivered a cartridge to a tape drive but the drive does not confirm tape loading status. The “xx” part of the SAC identifies the drive.</b>   |
|              | Retry the operation by manually loading a cartridge into the tape drive. Replace the failing drive module if this operation failed.   |
|              | Contact ATAC.   |
| 98 xx        | <b>The firmware installed on the tape drive is not supported by the library. The “xx” part of the SAC identifies the drive</b>  |
|              | Replace the tape drive module with a certified spare part.  |

**Table 8** Service Action Code Descriptions

| Reported SAC | Error and Solution  |
|--------------|---|
| A0 xx        | <b>Communication is not established between the main controller PCBA and the auxiliary controller PCBA's in the library.</b>  |
|              | Contact ATAC.   |
| A1 xx        | <b>Communication was established but has been lost between the main controller PCBA and the auxiliary controller PCBA's in the library.</b>   |
|              | Contact ATAC.   |
| A2 xx        | <b>Communication was initially established but is now lost between the main controller PCBA and the picker control PCBA.</b>  |
|              | Contact ATAC.   |
| A3 xx        | <b>Communication was initially established but is not lost between the main controller PCBA and the display control PCBA.</b>   |
|              | Contact ATAC.   |
| D2 xx        | <b>The Library detected that a fan has failed in one of the DC power supplies.</b>  |
|              | If this Library has only one DC power supply, replace the DC power supply.  |
|              | If this Library has two DC power Supplies, listen to the fan located on the back of each power supply. Replace the power supply that does not have the fan running.   |
| E0 xx        | <b>A cartridge is stuck in the picker assembly, operator intervention is required to remove the cartridge from the grip fingers.</b>  |
|              | Remove the cartridge.   |
| E1 xx        | <b>The mailbox door is not fully closed.</b>  |
|              | Close the mailbox door  |
| E2 xx        | <b>The front door is not fully closed, operator intervention is required to close the door.</b>   |
|              | Close the front door.   |
| E7 xx        | <b>The picker assembly detected that a cartridge is not present in the grip fingers. The cartridge may not be seated properly in the grip fingers or the get operation is not successful. Locate the cartridge in question.</b> |
|              | If the cartridge is not properly seated in the grip fingers. Remove the cartridge, insert it in any empty slot and retry the operation.   |
|              | If the cartridge is not in the picker but located in its original slot, the cartridge may be seated too tightly in the slot. Replace the magazine, re-inventory and retry the operation.  |
|              | Contact ATAC.   |



**Table 8** Service Action Code Descriptions

| Reported SAC | Error and Solution   |
|--------------|--|
| E8 xx        | <b>During a put cartridge after a successful get command, the picker assembly detected that the cartridge is no longer present in the grip fingers. Locate the missing cartridge.</b>  |
|              | If a cartridge is found, recover the cartridge, re-inventory the library and retry the operation.  |
|              | Contact ATAC.  |
| EB xx        | <b>An invalid library configuration was detected: the AIT drive modules are not installed in the allowable configurations.</b>   |
|              | Check to make sure that AIT tape drive modules are installed as specified in the procedure <a href="#">Installing/Removing Drives</a> on page 27. Drive module 1 must be installed starting at slot 2 of the drive column and additional modules occupying drive slots (3 to 5) moving upward with no gap between modules. |
| FB xx        | <b>Annual reminder.</b>  |
|              | This is an annual reminder to inspect the library for dust accumulation on the front door air vents. Blocked vents could affect the airflow required for proper cooling drives and electronics.  |
|              | After inspecting the air vents for dust accumulation, the SAC FB can be cleared for another year by choosing one of the following options on the operator panel: select <b>More &gt; Service &gt; Start &gt; Normal &gt; Next</b> or <b>OK &gt; Cancel</b> or <b>OK</b> to continue normal operation.                      |

## Operator Intervention Messages

When operator intervention is required, operator intervention messages display on the operator panel.

Operator intervention messages are up to four lines in length. The third and/or fourth lines may contain variable information specific to the message. For SAC indications, refer to [Service Action Codes](#) on page 97.

**Table 9** Operator Intervention Messages

| Message Lines   | Variables                                       |
|---|---|
| Alert not found.<br>Press OK.                                 | None  |
| -->ERROR!<--<br>Initialization Error<br>Code: 0x%Y            | %Y = 4 digit error modifier                     |
| -->PERM ERROR!<--<br>CALL FOR SERVICE<br>SAC :%X<br>Code:0x%Y | %X = 2 digit hex<br>%Y = 4 digit error modifier |

**Table 9** Operator Intervention Messages

| Message Lines   | Variables   |
|---|---|
| -=>PERM ERROR!<=-<br>SYSTEM WILL REBOOT<br>SAC :%X<br>Code:0x%Y                           | %X = 2 digit hex<br>%Y = 4 digit error modifier   |
| ->SYSTEM REBOOTED<-<br>NEW CODE LOADED<br><br>Version %X.%YY.%ZZZZ                        | current version<br>%X = 1 digit major rev<br>%Y = 2 digit minor rev<br>%Z = 4 digit minor rev |
| ->SYSTEM REBOOTED<-<br>RECOVERED FROM<br>ERROR<br>SAC :%X<br>Code:0x%Y                    | %X = 2 digit hex<br>%Y = 4 digit error modifier   |
| ->SYSTEM REBOOTED<-<br>CALL FOR SERVICE<br>SAC :%X<br>Code:0x%Y                           | %X = 2 digit hex<br>%Y = 4 digit error modifier   |
| ->TOO MANY ERRORS!<-<br>CALL FOR SERVICE<br>SAC :%X<br>Code:0x%Y                          | %X = 2 digit hex<br>%Y = 4 digit error modifier   |
| INTERVENTION NEEDED!<br>Please close the Mailbox to<br>complete the action.               | None  |
| INTERVENTION NEEDED!<br>Unexpected door open<br>detected. Make sure the door<br>is closed | None  |
| INTERVENTION NEEDED!<br>Single-ended device<br>detected on this Differential<br>bus.      | None  |
| INTERVENTION NEEDED!<br>Check SCSI bus port0<br>connector and/or<br>termination.          | None  |
| INTERVENTION NEEDED!<br>Remove cartridge in<br>picker and return to storage.              | None  |
| BAD MEDIA<br>Cannot get type.<br>Please label media.<br>Slot [%X %Y %Z]                   | %X = column number<br>%Y = magazine number<br>%Z = row number                                 |

**Table 9** Operator Intervention Messages

| Message Lines   | Variables  |
|---|--|
| INTERVENTION NEEDED!<br>Remove cartridge<br>from slot.<br>Slot [%X %Y %Z]                 | %X = column number<br>%Y = magazine number<br>%Z = row number                      |
| UPSIDE DOWN MEDIA<br>Ensure cartridge is<br>in slot properly.<br>Slot [%X %Y %Z]          | %X = column number<br>%Y = magazine number<br>%Z = row number                      |
| Slot IS OBSTRUCTED<br>Please check to see<br>if slot is empty.<br>Slot [%X %Y %Z]         | %X = column number<br>%Y = magazine number<br>%Z = row number                      |
| Slot IS EMPTY<br>Please check to see<br>if slot is full.<br>Slot [%X %Y %Z]               | %X = column number<br>%Y = magazine number<br>%Z = row number                      |
| DRIVE COMM FAILED<br>Please verify drive<br>communication path.<br>Drive %N [%X %Y %Z]    | %N = drive number<br>%X = column number<br>%Y = magazine number<br>%Z = row number |
| DRIVE SCSI ID FAILED<br>Please verify drive<br>SCSI id setting for<br>Drive %N [%X %Y %Z] | %N = drive number<br>%X = column number<br>%Y = magazine number<br>%Z = row number |
| TAPE PUSH FAILED<br>Please remove tape<br>from drive.<br>Drive %N [%X %Y %Z]              | %N = drive number<br>%X = column number<br>%Y = magazine number<br>%Z = row number |
| DRIVE INIT FAILED<br>Please correct drive<br>initialization for<br>Drive %N [%X %Y %Z]    | %N = drive number<br>%X = column number<br>%Y = magazine number<br>%Z = row number |
| DRIVE CLEAN FAILED<br>A cleaning operation failed to<br>clean<br>Drive %N [%X %Y %Z]      | %N = drive number<br>%X = column number<br>%Y = magazine number<br>%Z = row number |
| INVALID LABEL<br>Please check media for valid<br>label<br>Slot [%X %Y %Z]                 | %X = column number<br>%Y = magazine number<br>%Z = row number                      |
| DUPLICATE LABEL<br>Please check volders at<br>element address<br>%X and %Y                | %X = element address<br>%Y = element address                                       |

**Table 9** Operator Intervention Messages

| <b>Message Lines</b>  | <b>Variables</b>   |
|---|--|
| SER NUMBER MISSING<br>Please enter the system serial number via the monitor.  | None   |
| One or more drives has downlevel firmware. You may wish to update these drives. See User's Guide                    | None   |
| Your library firmware versions do not match. Download the latest version to the library.                            | None   |
| The Use-Count must be less than the Max-Count.<br>Value Range : 0-99  | None   |
| AutoClean is disabled. Access is denied. Use AutoClean's Setup menu to enable.                                      | None   |
| No Fixed cleaning slots installed. AutoClean access is denied.  | None   |
| You are changing the mailbox configuration AutoClean will automatically be disabled.                                | None   |
| CLEAN TAPE MISSING<br>A previously defined tape is missing: %X  | %X = cartridge number  |
| CLEAN TAPE EXPIRED<br>Please remove the cleaning tape number %X   | %X = cartridge number  |
| No cleaning tape in cleaning slot %X Write down data. Will remove record. Use-Count : %Y<br>Max-Count : %Z          | %X = slot number<br>%Y = use-count number<br>%Z = max-count number |
| Cleaning Power-Out<br>Recovery failed for slot %X. Write down data and remove tape Use-Count : %Y<br>Max-Count : %Z | %X = slot number<br>%Y = use-count number<br>%Z = max-count number |
| No record for existing cleaning tape. Remove cleaning tape from slot %X manually and insert it via the front panel. | %X = slot number   |

**Table 9** Operator Intervention Messages

| Message Lines  | Variables             |
|--|-----------------------|
| Cleaning tape %X has expired. Export the cleaning tape via the front panel. See User's Guide       | %X = cartridge number |
| Your cleaning tapes are expired or not in the system. Please import a new cleaning tape.           | None                  |
| %X of cleaning tape failed. Tape should not be in target position.                                 | %X = Import or Export |
| There is no cleaning slot available for importing new cleaning tapes.                              | None                  |
| Invalid cleaning tape inserted.  | None                  |
| WARNING - There are no cleaning tapes available in any of your cleaning cells to perform cleaning. | None                  |
| There is no cleaning tape available in cleaning cell %X to perform cleaning.                       | %X = slot number      |
| There is no tape in [ 1 A 1 ].<br><br>Please insert a cleaning tape and retry import.              | None                  |
| Mailbox is configured as storage. AutoClean may not be enabled.                                    | None                  |

## Operator Information Messages

---

Operator Information Messages are messages that display on the operator panel and give the library status. [Table 10](#) explains the variables associated with the operator information messages.

**Table 10** Operator Information Messages

| Message Lines | Variables |
|---------------|-----------|
| INITIALIZING  | None      |
| OFFLINE       | None      |

**Table 10** Operator Information Messages

| Message Lines        | Variables          |
|----------------------|--------------------|
| ONLINE               | None               |
| HOMING PICKER        | None               |
| TEACHING COLUMN [%X] | %X = column number |
| SCANNING COLUMN [%X] | %X = column number |
| INITIALIZING DRIVES  | None               |
| GOING READY          | None               |
| DOOR IS OPEN         | None               |
| PICKER HOME FAIL     | None               |
| PICKER NOT HOME      | None               |
| GOING ONLINE         | None               |
| GOING OFFINE         | None               |
| -=>ERROR!<=-         | None               |
| REBOOTING            | None               |
| CARTRIDGE RECOVERY   | None               |
| CARTRIDGE IN PICKER  | None               |
| SELF TEST FAILED     | None               |

## Interpreting Drive LEDs

---

For information on interpreting drive LEDs, go to the drive manufacturer's website and download the latest drive manual.

# 13

## Specifications

Depending on your drive type, many physical characteristics of your library will differ. The following sections provide specific information about your library, including cartridge capacity and allowed tape cartridges.

### Power

The library contains an internal auto-ranging power supply that accepts 90 to 260 volt and provides automatic input voltage and frequency selection. Conducted emissions are reduced by an AC line filter. The electrical specifications for the library are shown in [Table 11](#).

**Table 11** Power Specifications

| Input Power                            | 115 to 230 VAC |        |
|--|----------------|--------|
|  | W              | BTU/hr |
| Typical Power Consumption <sup>a</sup> |                |        |
| Library                                | 93             | 317    |
| LTO-2 drive sled                       | 31             | 103    |
| LTO-1 drive sled                       | 40             | 136    |
| LTO-3 drive sled                       | 30             | 101    |
| AIT                                    | 40             | 136    |
| DLT 8000                               | 44             | 150    |
| SDLT-320                               | 29             | 99     |
| SDLT-600                               | 28             | 94     |
| SNC 6101 (FC)                          | 30             | 102    |
| SNC 4500 (iSCSI)                       | 15             | 51     |

a. Power consumption is obtained using RMS values for voltage and current. Drive sled power consumption is taken while writing to a tape.

## Tape Cartridge Capacity

---

The tape cartridge capacity of the Scalar 100 is determined by the media type. The maximum cartridge configuration includes a bulk load mailbox feature.

**Table 12** Tape Cartridge Capacity

| Media Type | Magazine Capacity | Number of Tape Cartridges in Standard Mailbox | Number of Tape Cartridges in Bulk Load Mailbox | Total Number of Tape Cartridges <sup>a</sup><br>(With a Bulk Load Mailbox) |
|------------|-------------------|---|--|--|
| AIT        | 8                 | 2   | 16   | 96   |
| DLT/SDLT   | 5                 | 1   | 10   | 60   |
| LTO        | 6                 | 1   | 12   | 72   |

a. These values do not include three additional cleaning slots.

## Drive Capacity

---

The drive capacity is determined by the type of library. The following table shows the number of drives for each type of library.

**Table 13** Number of Allowed Drives

| Drive Type | Number of Allowed Drives |
|------------|--------------------------|
| AIT        | 2, 4, 6, or 8            |
| DLT/SDLT   | 1 to 6                   |
| LTO        | 1 to 6                   |

## Allowed Tape Cartridges and Storage Capacity

---

For each drive type, different tape cartridges are supported, resulting in different storage capacities and transfer rates.

The following sections provide information on what type of tape cartridges can be used for each drive type. Tape cartridges written in formats that are not supported by the installed drives should not be introduced into the Scalar 100.



# AIT

Refer to [Table 14](#) for each AIT tape cartridge compatibility with each AIT tape drive and native storage capacity.



## Note

If you use an AIT WORM tape cartridge in a drive that is not WORM enabled, no data can be read from or written to that tape cartridge.

**Table 14** Allowed AIT Tape Cartridges and Native Capacity

|                      |                        | AIT Tape Cartridge Types |       |                |                |                |
|----------------------|------------------------|--------------------------|-------|----------------|----------------|----------------|
|                      |                        | AIT-1                    | AIT-2 | AIT-2 WORM     | AIT-3          | AIT-3 WORM     |
| AIT Tape Drive Types | AIT-2 LVD <sup>a</sup> | 25 GB                    | 50 GB | Not Supported. | Not Supported. | Not Supported. |
|                      | AIT-2 HVD <sup>b</sup> | 25 GB                    | 50 GB | Not Supported. | Not Supported. | Not Supported. |
|                      | AIT-3 LVD              | 25 GB                    | 50 GB | Not Supported. | 100 GB         | 100 GB         |

a. The Scalar 100 AIT-2 LVD library configuration does not support AIT WORM technology.

b. The Scalar 100 AIT-2 HVD library configuration does not support AIT WORM technology.

## SDLT/DLT

Refer to [Table 15](#) on page 114 for each SDLT/DLT tape cartridge compatibility with each SDLT/DLT tape drive and native storage capacity.



Note

A DLT cleaning tape cannot be used in an SDLT drive.



CAUTION

If a SDLT-220 drive overwrites a 320-formatted tape, all data on that tape is lost. This includes any attempt to space past the data written with the SDLT-220 drive and read the original data.

**Table 15** Allowed SDLT/DLT Tape Cartridges and Native Capacity

|                      |          | DLT tape III                        | DLT tape IIIXT                      | DLT tape IV                         | SDLT tape I         | SDLT tape II  |
|----------------------|----------|-------------------------------------|-------------------------------------|-------------------------------------|---------------------|---------------|
| SDLT/DLT Drive Types | DLT-7000 | 10 GB                               | 15 GB                               | 35 GB                               | Not supported       | Not supported |
|                      | DLT-8000 | 10 GB                               | 15 GB                               | 40 GB                               | Not supported       | Not supported |
|                      | SDLT-220 | Not supported and may damage drive. | Not supported and may damage drive. | (read-only <sup>a</sup> )           | 110 GB              | Not supported |
|                      | SDLT-320 | Not supported and may damage drive. | Not supported and may damage drive. | (read-only <sup>b</sup> )           | 160 GB <sup>c</sup> | Not supported |
|                      | SDLT-600 | Not supported and may damage drive. | Not supported and may damage drive. | Not supported and may damage drive. | 160 GB (read-only)  | 300 GB        |

a. The drive will read at whatever speed the data was originally written at.

b. The drive will read at whatever speed the data was originally written at.

c. The SDLT 320 drive will read and write to 220-formatted tapes at SDLT 220 speeds.

# LTO

Refer to [Table 16](#) for each LTO tape cartridge compatibility with each LTO tape drive and native storage capacity.

**Table 16** Allowed LTO Cartridges and Native Capacity

|                      |   | LTO Tape Cartridge Types |                      |                      |
|----------------------|---|--------------------------|----------------------|----------------------|
|                      |   | Generation 1 (LTO-1)     | Generation 2 (LTO-2) | Generation 3 (LTO-3) |
| LTO Tape Drive Types | <b>Ultrium Internal Tape Drive — Generation 1 (LVD and HVD)</b> | 100 GB                   | Not Supported        | Not Supported        |
|                      | <b>Ultrium 2 Tape Drive — Generation 2 (LVD)</b>                | 100 GB <sup>a</sup>      | 200 GB               | Not Supported        |
|                      | <b>Ultrium 3 Tape Drive — Generation 3 (LVD)</b>                | 100 GB <sup>b</sup>      | 200 GB <sup>c</sup>  | 400 GB               |

a. LTO-1 tape cartridges are read/write compatible with LTO-2 drives.

b. LTO-3 tape cartridges are read-only compatible with LTO-3 drives.

c. LTO-2 tape cartridges are read/write compatible with LTO-3 drives.



# Index

| A   |            |
|---|------------|
| ADIC                                      |            |
| contacting                                | 2          |
| AIT                                       |            |
| drive capacity                            | 112        |
| drives                                    | 4          |
| native capacity                           | 113        |
| tape cartridge capacity                   | 112        |
| tape cartridges, allowed                  | 113        |
| AIT, <i>See</i> WORM                      |            |
| audience                                  |            |
| intended                                  | 1          |
| AutoClean                                 |            |
| <i>See also</i> cleaning cartridges       |            |
| about                                     | 34         |
| cleaning cartridges                       | 64         |
| disabling                                 | 35         |
| enabling                                  | 35         |
| B   |            |
| backlight                                 |            |
| operator panel                            | 69         |
| barcode labels <i>See</i> barcode scanner |            |
| barcode scanner                           |            |
| about                                     | 8          |
| applying labels                           | 86         |
| barcode length                            | 70         |
| exercising                                | 79         |
| label requirements                        | 86         |
| reading barcodes                          | 69, 70     |
| reading on power up                       | 69, 70     |
| browsers                                  |            |
| RMU, supported                            | 90         |
| buttons                                   |            |
| using                                     | 41         |
| C   |            |
| cabling                                   |            |
| installing                                | 15         |
| capacity                                  |            |
| drives                                    | 112        |
| library                                   | 112        |
| casters                                   |            |
| installing                                | 27         |
| cleaning cartridges                       |            |
| importing                                 | 65         |
| viewing status                            | 64         |
| communication                             |            |
| host                                      | 22         |
| Complete Log report                       | 94         |
| contacting                                |            |
| ADIC                                      | 2          |
| Customer Service Center                   |            |
| website                                   | 2          |
| D   |            |
| date                                      |            |
| setting                                   | 72, 93     |
| demo                                      |            |
| running                                   | 80         |
| DLT, <i>See</i> SDLT/DLT                  |            |
| documentation                             |            |
| Quick Start Guide                         | 13         |
| documents                                 |            |
| additional                                | 2          |
| latest versions                           | 2          |
| release notes                             | 2          |
| drive modules                             |            |
| about                                     | 8          |
| numbering                                 | 10         |
| slot numbering                            | 9          |
| drivers                                   |            |
| installing                                | 19         |
| drives                                    |            |
| AIT                                       | 4          |
| cleaning                                  | 34         |
| diagnostics                               | 83         |
| drivers                                   | 19         |
| error codes (LTO)                         | 40         |
| filler plates                             | 8          |
| firmware                                  | 75, 76, 94 |
| FUP tapes                                 | 76         |
| information about                         | 52         |

|                               |        |
|-------------------------------|--------|
| installing                    | 27     |
| LEDs                          | 110    |
| library capacity              | 112    |
| logs                          | 54     |
| LTO                           | 4      |
| modules                       | 8      |
| operator panel representation | 38     |
| removing                      | 28, 82 |
| replacing                     | 29, 82 |
| resetting                     | 82     |
| SCSI IDs                      | 71     |
| SDLT/DLT                      | 4      |
| status                        | 38, 47 |
| supported                     | 4      |
| tape cartridges, allowed      | 112    |
| unloading, tape cartridges    | 66     |
| WORM                          | 4      |

---

## E

---

|                                 |          |
|---------------------------------|----------|
| emulation                       |          |
| setting                         | 67       |
| errors                          |          |
| <i>See also</i> logs            |          |
| <i>See also</i> troubleshooting |          |
| diagnostic files                | 94       |
| explanation                     | 97       |
| LEDs                            | 110      |
| logs                            | 53       |
| meaning                         | 105, 109 |
| Operator Information messages   | 109      |
| operator intervention messages  | 105      |
| operator panel                  | 41       |
| SACs                            | 97       |
| SACs, displaying                | 75       |
| exercises                       |          |
| demo                            | 80       |
| self test                       | 81       |
| exporting                       |          |
| tape cartridges                 | 63       |

---

## F

---

|  |            |
|--|------------|
| filler plates                                |            |
| about  | 8          |
| firmware                                     |            |
| drives                                       | 75, 76, 94 |
| installed level                              | 48, 91     |
| library                                      | 75, 94     |
| RMU  | 75, 91, 94 |
| updating                                     | 75, 94     |
| Firmware Upgrade Tapes, <i>See</i> FUP tapes |            |
| floor model library                          |            |
| casters                                      | 27         |
| side panels                                  | 26         |
| FUP tapes                                    |            |
| creating                                     | 76         |

|       |    |
|-------|----|
| using | 76 |
|-------|----|

---

## H

---

|                           |    |
|---------------------------|----|
| hardware                  |    |
| installing optional       | 23 |
| help                      |    |
| contacting ADIC           | 2  |
| Customer Service Center   | 2  |
| RMU                       | 95 |
| Service Requests          | 2  |
| host                      |    |
| communication             | 22 |
| element addressing        | 19 |
| emulating other libraries | 67 |
| preparing                 | 16 |
| SCSI adapter              | 19 |
| HyperTerminal             |    |
| configuring               | 53 |
| printing logs with        | 53 |

---

## I

---

|                            |        |
|----------------------------|--------|
| importing                  |        |
| tape cartridges            | 63     |
| installing                 |        |
| configuring the library    | 67     |
| drivers                    | 19     |
| drives                     | 27     |
| getting started roadmap    | 13     |
| hardware                   | 23     |
| location                   | 14     |
| optional hardware          | 23     |
| power cord                 | 15     |
| preparing the host         | 16     |
| Quick Start Guide          | 13     |
| Scalar 100                 | 13     |
| SCSI Adapter               | 19     |
| SCSI cables                | 15     |
| terminators                | 15     |
| unpacking                  | 14     |
| intended use               |        |
| statement                  | 1      |
| Internet Explorer          |        |
| RMU                        | 90     |
| inventory                  |        |
| Library Inventory report   | 94     |
| taking                     | 61, 81 |
| tape cartridge information | 52     |
| teaching                   | 81     |

---

## K

---

|             |    |
|-------------|----|
| key strokes |    |
| setting     | 69 |

---

L

---

|                          |        |
|--------------------------|--------|
| LEDs                     |        |
| interpreting             | 110    |
| library                  |        |
| drivers                  | 19     |
| Library Controller       |        |
| updating firmware        | 75     |
| Library Inventory report | 94     |
| Library Log report       | 94     |
| lighting                 |        |
| operator panel           | 69     |
| lock                     |        |
| door                     | 5      |
| Mailbox                  | 73     |
| log-in                   |        |
| RMU                      | 91, 92 |
| logs                     |        |
| Command                  | 54     |
| Complete Log report      | 94     |
| Drive                    | 54     |
| Error                    | 54     |
| Library Inventory report | 94     |
| Library Log report       | 94     |
| printing                 | 53     |
| RMU                      | 95     |
| viewing                  | 95     |
| LTO                      |        |
| drive capacity           | 112    |
| drives                   | 4      |
| error codes              | 40     |
| FUP tapes, creating      | 76     |
| native capacity          | 115    |
| tape cartridge capacity  | 112    |
| tape cartridges, allowed | 115    |

---

M

---

|                                 |    |
|---------------------------------|----|
| magazines                       |    |
| about                           | 9  |
| Mailbox                         |    |
| as storage                      | 69 |
| AutoClean                       | 35 |
| import/export                   | 69 |
| locking/unlocking               | 73 |
| mailbox                         |    |
| See <i>also</i> tape cartridges |    |
| about                           | 5  |
| bulk load mailbox               | 5  |
| installing                      | 30 |
| removing                        | 30 |
| standard mailbox                | 5  |
| status                          | 41 |
| main menu                       |    |
| about                           | 44 |
| maintenance                     |    |
| advanced                        | 75 |

|                 |    |
|-----------------|----|
| normal          | 75 |
| menu tree       | 44 |
| menus           |    |
| main menu       | 44 |
| menu tree       | 44 |
| model number    |    |
| product         | 1  |
| moving          |    |
| picker          | 61 |
| tape cartridges | 60 |

---

N

---

|                    |    |
|--------------------|----|
| Netscape Navigator |    |
| RMU                | 90 |

---

O

---

|                                |        |
|--------------------------------|--------|
| offline/online                 |        |
| about                          | 46     |
| switching between              | 46     |
| Operator Information messages  |        |
| meaning                        | 109    |
| operator intervention messages |        |
| meaning                        | 105    |
| operator panel                 |        |
| about                          | 5, 37  |
| backlight                      | 69     |
| buttons                        | 41     |
| display information            | 38     |
| library messages               | 41     |
| main menu                      | 44     |
| menu tree                      | 44     |
| password protecting            | 73     |
| RMU                            | 95     |
| symbols                        | 38, 41 |

---

P

---

|                         |        |
|-------------------------|--------|
| parity                  |        |
| setting                 | 67     |
| password                |        |
| operator panel          | 73     |
| RMU                     | 91, 93 |
| picker                  |        |
| fingers, exercising     | 78     |
| home position           | 80     |
| moving                  | 61     |
| picker axes, exercising | 79     |
| statistics              | 47     |
| power                   |        |
| connecting              | 15     |
| front power switch      | 5      |
| rear power switch       | 7      |
| removing                | 7      |
| turning off the library | 59     |
| turning on the library  | 59     |

|   |          |  |  |
|---|----------|--|--|
| printing  |          |  |  |
| HyperTerminal   | 53       |  |  |
| logs  | 53       |  |  |
| <b>Q</b>  |          |  |  |
| Quick Start Guide                                       | 13       |  |  |
| <b>R</b>  |          |  |  |
| rackmount model library                                 |          |  |  |
| rackmounting  | 23       |  |  |
| release notes   |          |  |  |
| location  | 2        |  |  |
| Remote Management Unit, <i>See</i> RMU                  |          |  |  |
| replacing   |          |  |  |
| drives  | 29       |  |  |
| reports <i>See</i> logs                                 |          |  |  |
| resetting   |          |  |  |
| drives  | 82       |  |  |
| RMU   |          |  |  |
| about   | 8, 89    |  |  |
| browsers, supported                                     | 90       |  |  |
| diagnostic files  | 94       |  |  |
| firmware, updating                                      | 94       |  |  |
| Help  | 95       |  |  |
| IP address  | 90       |  |  |
| library status  | 91       |  |  |
| log-in  | 91       |  |  |
| logs  | 95       |  |  |
| MIB file  | 92       |  |  |
| opening   | 91       |  |  |
| operator panel  | 95       |  |  |
| password  | 93       |  |  |
| requirements  | 90       |  |  |
| setup   | 92       |  |  |
| SNMP  | 92       |  |  |
| subnet mask   | 90       |  |  |
| time/date   | 93       |  |  |
| updating firmware                                       | 75       |  |  |
| user accounts   | 92       |  |  |
| robotic system  |          |  |  |
| about   | 8        |  |  |
| <b>S</b>  |          |  |  |
| SACs  |          |  |  |
| displaying  | 75       |  |  |
| meaning   | 97       |  |  |
| safety  |          |  |  |
| intended use  | 1        |  |  |
| statements  | 1        |  |  |
| symbols and notes                                       | 1        |  |  |
| <i>System, Safety, and Regulatory Information Guide</i> | 1        |  |  |
| SCSI connections  |          |  |  |
| about   | 11       |  |  |
| cabling the library                                     | 15       |  |  |
| SCSI adapter  | 19       |  |  |
| SCSI IDs  |          |  |  |
| drives  | 71       |  |  |
| library   | 67       |  |  |
| SDLT/DLT  |          |  |  |
| cartridges  | 114      |  |  |
| drive capacity  | 112, 114 |  |  |
| drives  | 4        |  |  |
| native capacity   | 114      |  |  |
| tape cartridge capacity                                 | 112      |  |  |
| tape cartridges, allowed                                | 114      |  |  |
| security  |          |  |  |
| door lock   | 5        |  |  |
| Mailbox, locking  | 73       |  |  |
| operator panel  | 73       |  |  |
| RMU   | 91       |  |  |
| self test   |          |  |  |
| running   | 81       |  |  |
| sensor  |          |  |  |
| status  | 49       |  |  |
| serial number   |          |  |  |
| viewing   | 48, 91   |  |  |
| Service Action Codes, <i>See</i> SACs                   |          |  |  |
| Service Requests  |          |  |  |
| opening   | 2        |  |  |
| setting   |          |  |  |
| date  | 72, 93   |  |  |
| emulation   | 67       |  |  |
| parity  | 67       |  |  |
| retries   | 67       |  |  |
| SCSI ID, drives   | 71       |  |  |
| SCSI ID, library  | 67       |  |  |
| time  | 72, 93   |  |  |
| shut down   |          |  |  |
| library   | 59       |  |  |
| side panels   |          |  |  |
| installing  | 26       |  |  |
| Simple Network Management Protocol <i>See</i> SNMP      |          |  |  |
| slots   |          |  |  |
| number filled/empty                                     | 47       |  |  |
| numbering   | 9        |  |  |
| statistics about specific                               | 50       |  |  |
| status  | 50       |  |  |
| SNC   |          |  |  |
| about   | 8        |  |  |
| installing  | 23       |  |  |
| SNMP  |          |  |  |
| configuring   | 92       |  |  |
| MIB file  | 92       |  |  |
| sound   |          |  |  |
| key strokes   | 69       |  |  |
| status  |          |  |  |
| cleaning cartridges                                     | 64       |  |  |
| drives  | 38       |  |  |
| library   | 91       |  |  |
| mailbox   | 41       |  |  |



|   |    |                       |          |
|---|----|-----------------------|----------|
| sensor .....                                  | 49 | tape cartridges ..... | .67, 113 |
| storage columns                               |    | write-protecting      |          |
| installing .....                              | 33 | tape cartridges ..... | .85      |
| Storage Networking Controller, <i>See</i> SNC |    |                       |          |
| symbols and notes                             |    |                       |          |
| explained .....                               | 1  |                       |          |

## T

---

|                                     |         |
|-------------------------------------|---------|
| tape cartridges                     |         |
| <i>See also</i> cleaning cartridges |         |
| <i>See also</i> mailbox             |         |
| allowed .....                       | 85, 112 |
| barcodes .....                      | 8       |
| exporting .....                     | 63      |
| importing .....                     | 63      |
| information about a specific .....  | 52      |
| inserting, manually .....           | 63      |
| inventory .....                     | 61      |
| library capacity .....              | 112     |
| magazines .....                     | 9       |
| moving .....                        | 60      |
| number filled/empty .....           | 47      |
| removing, manually .....            | 64      |
| slot numbering .....                | 9       |
| storage capacity .....              | 112     |
| usage guidelines .....              | 85      |
| WORM .....                          | 67, 113 |
| write-protecting .....              | 85      |
| terminators                         |         |
| installing .....                    | 15      |
| time                                |         |
| setting .....                       | 72, 93  |
| training                            |         |
| contact ADIC .....                  | 2       |
| troubleshooting                     |         |
| <i>See also</i> errors              |         |
| self test .....                     | 81      |
| turning off                         |         |
| library .....                       | 59      |
| turning on                          |         |
| library .....                       | 59      |
| scanning on .....                   | 69      |
| touch on .....                      | 69      |

## U

---

|                            |    |
|----------------------------|----|
| unlocking, <i>See</i> lock |    |
| unpacking .....            | 14 |

## W

---

|                               |       |
|-------------------------------|-------|
| website                       |       |
| Customer Service Center ..... | 2     |
| WORM                          |       |
| about .....                   | 4, 67 |
| configuring .....             | 67    |

